

**PLEASE CHECK WWW.MOLEX.COM FOR LATEST PART INFORMATION**

**Part Number:** [35312-0360](#)  
**Status:** **Active**  
**Description:** 2.50mm Pitch Header, Vertical, Shrouded, with Positive Lock, 3 Circuits, PA Polyamide (Nylon) 6/6, Glass-filled, Natural

**Documents:**

<a href="#">3D Model</a>	<a href="#">Packaging Specification PK-35312-013 (PDF)</a>
<a href="#">Drawing (PDF)</a>	<a href="#">Packaging Specification PK-35312-014 (PDF)</a>
<a href="#">Product Specification PS-35155-002 (PDF)</a>	<a href="#">RoHS Certificate of Compliance (PDF)</a>

**Agency Certification**

CSA	LR19980
TUV	E9450420E01
UL	E29179

**General**

Product Family	PCB Headers
Series	<a href="#">35312</a>
Application	Signal, Wire-to-Board
Product Name	N/A
UPC	822348691159

**Physical**

Breakaway	No
Circuits (Loaded)	3
Circuits (maximum)	3
Color - Resin	Natural
Durability (mating cycles max)	30
First Mate / Last Break	No
Flammability	94V-0
Glow-Wire Compliant	No
Guide to Mating Part	No
Keying to Mating Part	None
Lock to Mating Part	Yes
Material - Plating Mating	Tin
Material - Plating Termination	Tin
Material - Resin	Nylon
Net Weight	0.408/g
Number of Rows	1
Orientation	Vertical
PC Tail Length	3.40mm
PCB Locator	No
PCB Retention	None
PCB Thickness - Recommended	1.60mm
Packaging Type	Bag
Pitch - Mating Interface	2.50mm
Pitch - Termination Interface	2.50mm
Plating min - Mating	5.080µm
Plating min - Termination	5.080µm
Polarized to PCB	No
Shrouded	Partial
Stackable	No
Surface Mount Compatible (SMC)	No
Temperature Range - Operating	-40°C to +105°C
Termination Interface: Style	Through Hole

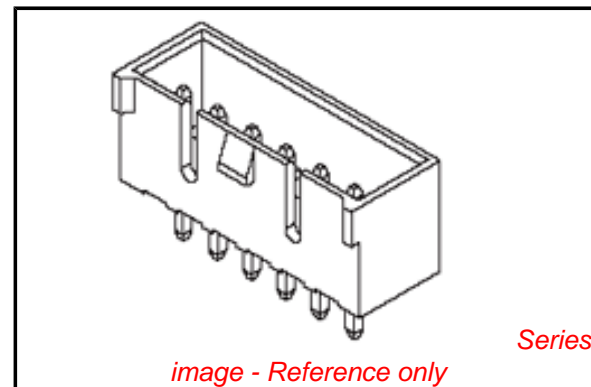

*image - Reference only*

**EU RoHS**

**ELV and RoHS Compliant**

**REACH SVHC**

Not Reviewed

**Low-Halogen Status**

**Not Low-Halogen**

**China RoHS**



**Need more information on product environmental compliance?**

Email [productcompliance@molex.com](mailto:productcompliance@molex.com)  
 For a multiple part number RoHS Certificate of Compliance, [click here](#)

Please visit the [Contact Us](#) section for any non-product compliance questions.

**Search Parts in this Series**

[35312Series](#)

**Mates With**

Wire-to-Wire and Wire-to-Board Housing  
[35572 Crimp Housing](#), [35155](#)

**Electrical**

Current - Maximum per Contact

3A

Voltage - Maximum

250V

**Material Info****Reference - Drawing Numbers**

Packaging Specification

PK-35312-013, PK-35312-014

Product Specification

PS-35155-002

Sales Drawing

SD-35312-001, SD-35312-004, SD-35312-005

This document was generated on 01/15/2015

**PLEASE CHECK [WWW.MOLEX.COM](http://WWW.MOLEX.COM) FOR LATEST PART INFORMATION**