

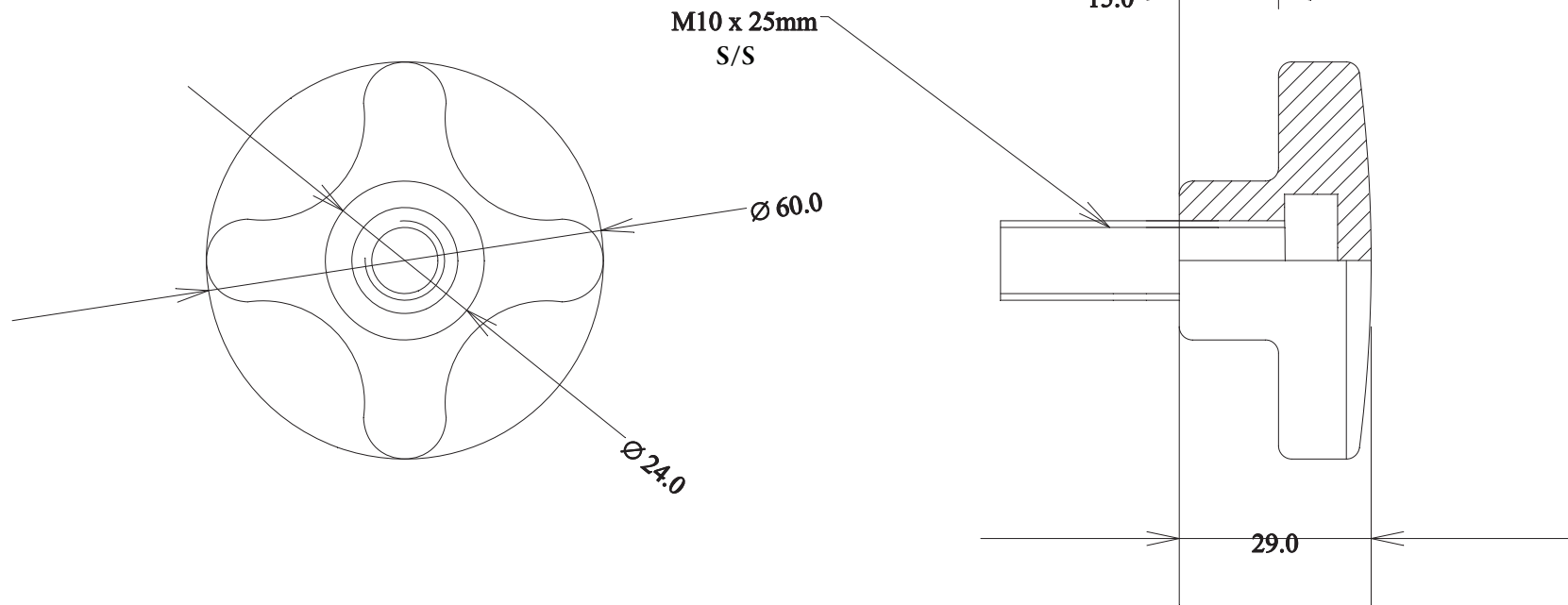

RevNo	Revision note	Date	Signature	Checked
-------	---------------	------	-----------	---------



ItemRef	Quantity	Title	Star Knob - Polypropylene REV.2		Article No./Reference	
Designed by	Checked by	Approved by - date	Filename	Date	Scale	
				06/04/10		
				RS 7027746		
				Edition	Sheet	
				1	1/1	