

Bourdon tube pressure gauges, liquid filled,

Modelcode type: 213.53.0XX

Item number: 82543094

Description

Design according	EN 837-1
Accuracy class	class 1.6
Scale range	0...1.6 bar
2nd Scale or Special Scale	2nd scale MPa

Constructional design

Process connection	G 1/4 B
Connector location	lower mount
Pressure element	Copper alloy
Movement	Copper alloy
Case	Crimp ring case (version 53)
Nominal size	063 mm
Restrictor	brass, D 0.5
Case filling fluid	Silicon oil M50
Pointer	Alu Pointer - Plastic Connector (double division)
Window	plastic, clear
Dial	plastic, white, with stop-pin

Operating conditions

Pressure limitation	Steady: 3/4 x full scale value Fluctuating: 2/3 x full scale value Short time: Full scale value
Permissible ambient temperature	-20 ... +60 °C
Permissible medium temperature	+60°C maximum
Temperature effect when the temperature deviates from the reference temperature (+20°C)	Max. +/-0.4 %/10 K of the span
Ingress protection	IP 65

Dial description:

Pressure Gauge Standard	China
-------------------------	-------

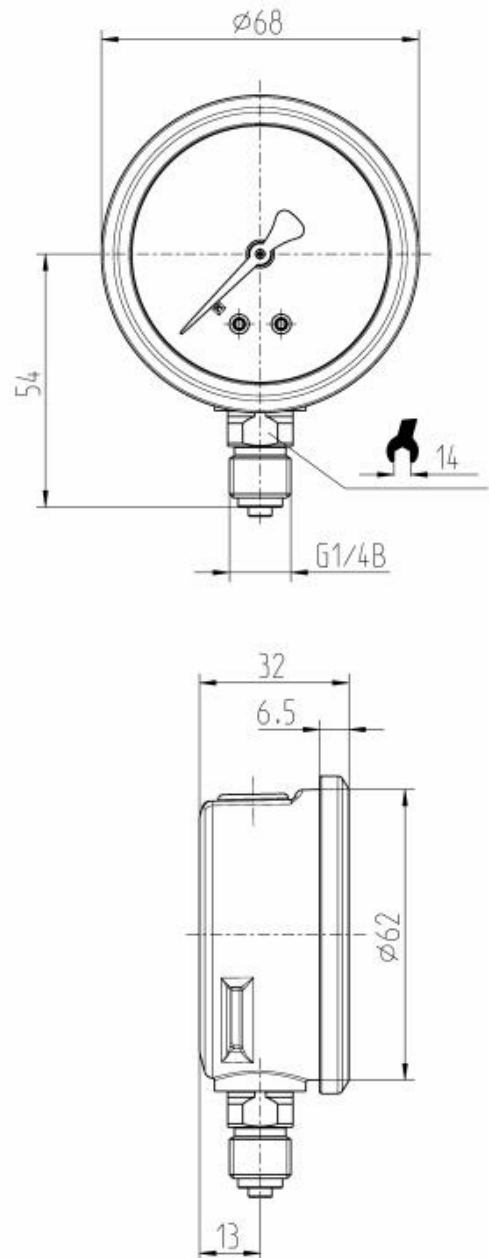

Bourdon tube pressure gauges, liquid filled,

Modelcode type: 213.53.0XX

Item number: 82543094

color for 1.scale (outside)	black
color for 2.scale (inside)	red RAL 3020
dial background	White
Manufacturer logo	*WIKA*
stop pin on dial	at zero
norm-mark on dial	*EN 837-1*
safetymark on dial	*S*
accuracy class on dial	*Cl.1.6*
Labelcode	
Label	WIKA standard
language of the label	German