



Mechanical features

Weight g 450

Ambient conditions

IEC degree of protection IP65

Dimensions

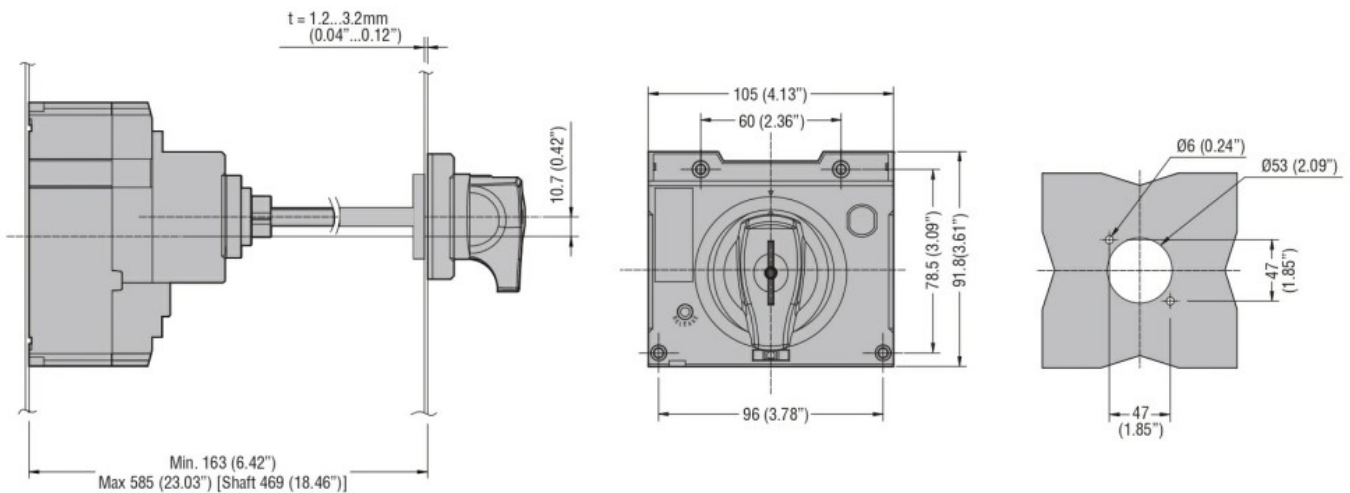

Certifications and compliance

Certificates

ETIM classification

EC000066 - Power contactor, AC switching