

### Cree® XLamp® XT Family LEDs

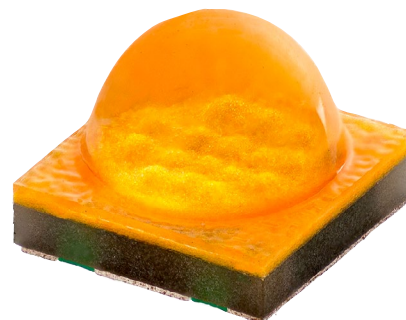
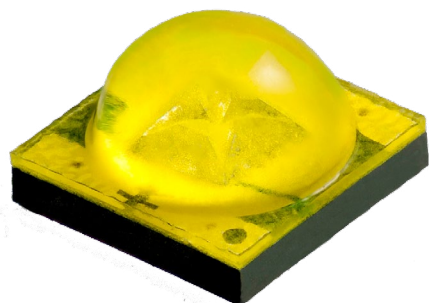

#### TABLE OF CONTENTS

Introduction.....	1
Bin and Order-Code Format .....	2
Performance Groups – Brightness .....	3
Performance Groups – Radiant Flux.....	3
Performance Groups – Dominant Wavelength .....	4
Performance Groups – Forward Voltage .....	4
Performance Groups – Chromaticity .....	5
Cree’s Standard White Chromaticity Regions Plotted on the CIE 1931 Curve.....	9
Cree’s Standard Cool White Kits Plotted on ANSI Standard Chromaticity Regions.....	11
Cree’s Outdoor White Kits Plotted on ANSI Standard Chromaticity Regions .....	12
Cree’s Standard Warm and Neutral White Kits Plotted on ANSI Standard Chromaticity Regions.....	13
Cree’s 2450 K & 2200 K CCT White Kits Plotted on ANSI Standard Chromaticity Regions.....	14
Cree’s Standard Chromaticity Kits.....	15
Standard Order Codes and Bins	
XT-E ANSI Cool White .....	17
XT-E Neutral White .....	18
XT-E Warm White .....	20
12-Volt XT-E HVW Warm White.....	21
24-Volt XT-E HVW Neutral White.....	22
24-Volt XT-E HVW Warm White.....	22
48-Volt XT-E HVW ANSI Cool White.....	23
48-Volt XT-E HVW Neutral White.....	24
48-Volt XT-E HVW Warm White.....	25
XT-E Royal Blue.....	27

#### INTRODUCTION

This document describes the product nomenclature required to select and order Cree’s XLamp® XT Family LEDs. XLamp XT Family LEDs are tested and sorted into bins which are then combined into orderable kits identified by an order code.

All XLamp LEDs are tested and sorted by color and brightness into a unique bin. Each bin contains LEDs from only one color and brightness group and is uniquely identified by a bin code. White XLamp LEDs are sorted by chromaticity (color) and luminous flux (brightness). Color XLamp LEDs are sorted by dominant wavelength (color) and luminous or radiant flux (brightness). LEDs are shipped on reels containing LEDs from one bin and are always labeled with the appropriate bin code.

Kits contain LEDs from a number of similar bins and are fully defined by their order codes. A full explanation of the order codes for XLamp XT Family LEDs, as well as a list of standard order codes, is provided in this document.

### BIN AND ORDER-CODE FORMAT

Bin codes and order codes for XT-E White LEDs are configured in the following manner:

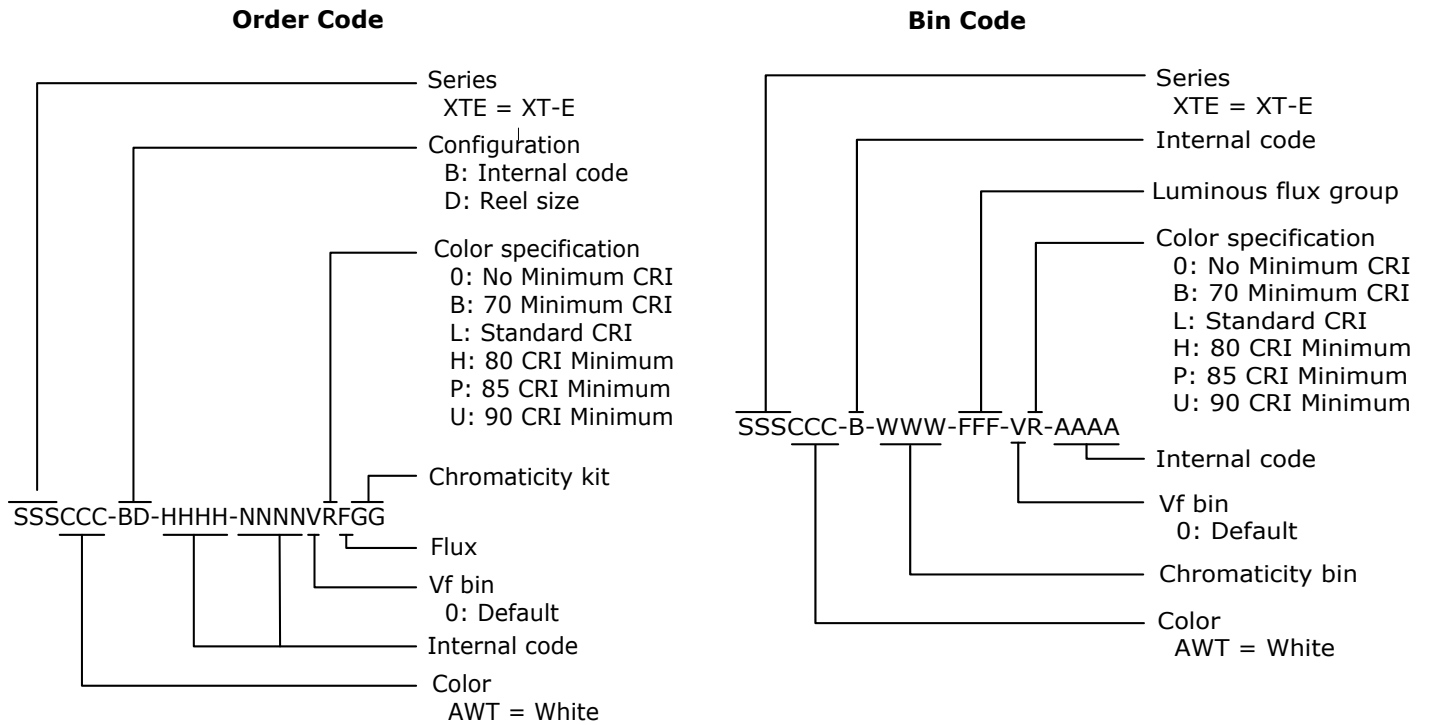

Bin codes and order codes for XT-E High Voltage White LEDs are configured as follows:

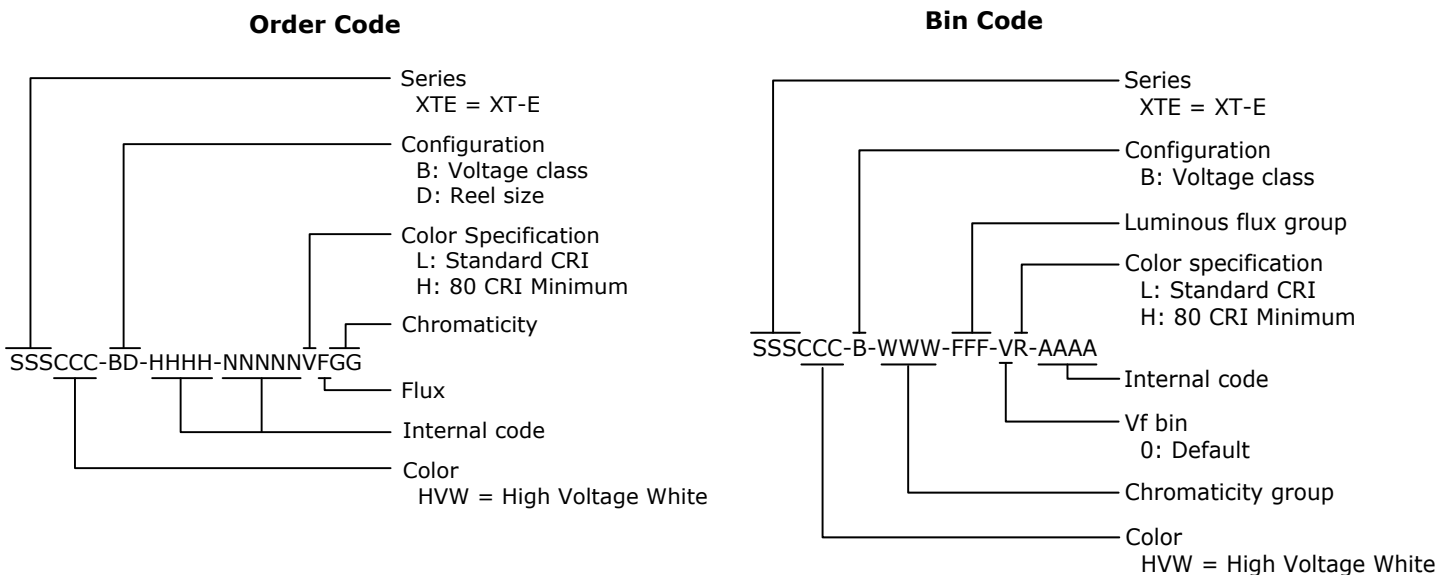

Bin codes and order codes for XT-E Royal Blue LEDs are configured as follows:

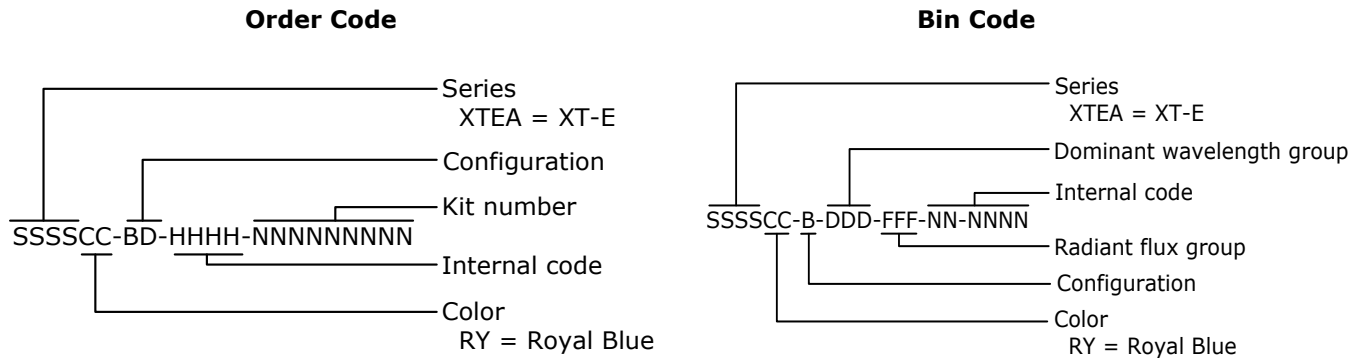

### PERFORMANCE GROUPS – BRIGHTNESS ( $T_j = 85\text{ }^\circ\text{C}$ )

XLamp XT-E White and XT-E High Voltage White LEDs are tested for luminous flux and placed into one of the following luminous-flux groups.

Group Code	Min. Luminous Flux	Max. Luminous Flux
N3	56.8	62
N4	62	67.2
P2	67.2	73.9
P3	73.9	80.6
P4	80.6	87.4
Q2	87.4	93.9
Q3	93.9	100
Q4	100	107
Q5	107	114
R2	114	122
R3	122	130
R4	130	139
R5	139	148
S2	148	156

### PERFORMANCE GROUPS – RADIANT FLUX ( $T_j = 85\text{ }^\circ\text{C}$ )

XLamp XT-E Royal Blue LEDs are tested for radiant flux and placed into one the following bins.

Group Code	Minimum Radiant Flux (mW)	Maximum Radiant Flux (mW)
31 (K)	475	500
32 (L)	500	525
33 (M)	525	550
34 (N)	550	575
35 (P)	575	600
36 (Q)	600	625

**PERFORMANCE GROUPS – DOMINANT WAVELENGTH ( $T_j = 85\text{ }^\circ\text{C}$ )**

XLamp XT-E Royal Blue LEDs are tested for dominant wavelength and placed into one of the regions defined by the following bounding coordinates.

Group Code	Minimum Dominant Wavelength (nm)	Maximum Dominant Wavelength (nm)
D36	450.0	452.5
D37	452.5	455.0
D46	455.0	457.5
D47	457.5	460.0
D56	460.0	462.5
D57	462.5	465.0

**PERFORMANCE GROUPS – FORWARD VOLTAGE ( $T_j = 85\text{ }^\circ\text{C}$ )**

48-V XLamp XT-E High Voltage White LEDs are tested for forward voltage at 22 mA and placed into one the following voltage bins.

Group Code	Minimum Forward Voltage (V)	Maximum Forward Voltage (V)
0	No Vf Bin	
1	40.0	42.5
2	42.5	45.0
3	45.0	47.5
4	47.5	50.0
5	50.0	52.5
6	52.5	55.0

XLamp XT-E White and Royal Blue LEDs are tested for forward voltage and placed into one the following voltage bins.

Group Code	Minimum Forward Voltage (V)	Maximum Forward Voltage (V)
F	2.75	3.00
G	3.00	3.25
H	3.25	3.50

**PERFORMANCE GROUPS – CHROMATICITY**

Region	x	y	Region	x	y	Region	x	y	Region	x	y
0A	0.2950	0.2970	0B	0.2920	0.3060	0C	0.2984	0.3133	0D	0.2984	0.3133
	0.2920	0.3060		0.2895	0.3135		0.2962	0.3220		0.3048	0.3207
	0.2984	0.3133		0.2962	0.3220		0.3028	0.3304		0.3068	0.3113
	0.3009	0.3042		0.2984	0.3133		0.3048	0.3207		0.3009	0.3042
0R	0.2980	0.2880	0S	0.2895	0.3135	0T	0.2962	0.3220	0U	0.3037	0.2937
	0.2950	0.2970		0.2870	0.3210		0.2937	0.3312		0.3009	0.3042
	0.3009	0.3042		0.2937	0.3312		0.3005	0.3415		0.3068	0.3113
	0.3037	0.2937		0.2962	0.3220		0.3028	0.3304		0.3093	0.2993
1A	0.3048	0.3207	1B	0.3028	0.3304	1C	0.3115	0.3391	1D	0.3130	0.3290
	0.3130	0.3290		0.3115	0.3391		0.3205	0.3481		0.3213	0.3373
	0.3144	0.3186		0.3130	0.3290		0.3213	0.3373		0.3221	0.3261
	0.3068	0.3113		0.3048	0.3207		0.3130	0.3290		0.3144	0.3186
1R	0.3068	0.3113	1S	0.3005	0.3415	1T	0.3099	0.3509	1U	0.3144	0.3186
	0.3144	0.3186		0.3099	0.3509		0.3196	0.3602		0.3221	0.3261
	0.3161	0.3059		0.3115	0.3391		0.3205	0.3481		0.3231	0.3120
	0.3093	0.2993		0.3028	0.3304		0.3115	0.3391		0.3161	0.3059
2A	0.3215	0.3350	2B	0.3207	0.3462	2C	0.3290	0.3538	2D	0.3290	0.3417
	0.3290	0.3417		0.3290	0.3538		0.3376	0.3616		0.3371	0.3490
	0.3290	0.3300		0.3290	0.3417		0.3371	0.3490		0.3366	0.3369
	0.3222	0.3243		0.3215	0.3350		0.3290	0.3417		0.3290	0.3300
2R	0.3222	0.3243	2S	0.3196	0.3602	2T	0.3290	0.3690	2U	0.3290	0.3300
	0.3290	0.3300		0.3290	0.3690		0.3381	0.3762		0.3366	0.3369
	0.3290	0.3180		0.3290	0.3538		0.3376	0.3616		0.3361	0.3245
	0.3231	0.3120		0.3207	0.3462		0.3290	0.3538		0.3290	0.3180
3A	0.3371	0.3490	3B	0.3376	0.3616	3C	0.3463	0.3687	3D	0.3451	0.3554
	0.3451	0.3554		0.3463	0.3687		0.3551	0.3760		0.3533	0.3620
	0.3440	0.3427		0.3451	0.3554		0.3533	0.3620		0.3515	0.3487
	0.3366	0.3369		0.3371	0.3490		0.3451	0.3554		0.3440	0.3427
3R	0.3366	0.3369	3S	0.3381	0.3762	3T	0.3480	0.3840	3U	0.3440	0.3428
	0.3440	0.3428		0.3480	0.3840		0.3571	0.3907		0.3515	0.3487
	0.3429	0.3307		0.3463	0.3687		0.3551	0.3760		0.3495	0.3339
	0.3361	0.3245		0.3376	0.3616		0.3463	0.3687		0.3429	0.3307
4A	0.3530	0.3597	4B	0.3548	0.3736	4C	0.3641	0.3804	4D	0.3615	0.3659
	0.3615	0.3659		0.3641	0.3804		0.3736	0.3874		0.3702	0.3722
	0.3590	0.3521		0.3615	0.3659		0.3702	0.3722		0.3670	0.3578
	0.3512	0.3465		0.3530	0.3597		0.3615	0.3659		0.3590	0.3521
4R	0.3512	0.3465	4S	0.3571	0.3907	4T	0.3668	0.3957	4U	0.3590	0.3521
	0.3590	0.3521		0.3668	0.3957		0.3771	0.4034		0.3670	0.3578
	0.3567	0.3389		0.3641	0.3804		0.3736	0.3874		0.3640	0.3440
	0.3495	0.3339		0.3548	0.3736		0.3641	0.3804		0.3567	0.3389

**PERFORMANCE GROUPS – CHROMATICITY (CONTINUED)**

Region	x	y	Region	x	y	Region	x	y	Region	x	y
5A	0.3702	0.3722	5B	0.3736	0.3874	5C	0.3870	0.3958	5D	0.3825	0.3798
	0.3825	0.3798		0.3870	0.3958		0.4006	0.4044		0.3951	0.3876
	0.3783	0.3646		0.3825	0.3798		0.3951	0.3876		0.3898	0.3716
	0.3670	0.3578		0.3702	0.3722		0.3825	0.3798		0.3783	0.3646
5A1	0.3670	0.3578	5A2	0.3686	0.3649	5A3	0.3744	0.3685	5A4	0.3726	0.3612
	0.3686	0.3649		0.3702	0.3722		0.3763	0.3760		0.3744	0.3685
	0.3744	0.3685		0.3763	0.3760		0.3825	0.3798		0.3804	0.3721
	0.3726	0.3612		0.3744	0.3685		0.3804	0.3721		0.3783	0.3646
5B1	0.3702	0.3722	5B2	0.3719	0.3797	5B3	0.3782	0.3837	5B4	0.3763	0.3760
	0.3719	0.3797		0.3736	0.3874		0.3802	0.3916		0.3782	0.3837
	0.3782	0.3837		0.3802	0.3916		0.3869	0.3958		0.3847	0.3877
	0.3763	0.3760		0.3782	0.3837		0.3847	0.3877		0.3825	0.3798
5C1	0.3825	0.3798	5C2	0.3847	0.3877	5C3	0.3912	0.3917	5C4	0.3887	0.3836
	0.3847	0.3877		0.3869	0.3958		0.3937	0.4001		0.3912	0.3917
	0.3912	0.3917		0.3937	0.4001		0.4006	0.4044		0.3978	0.3958
	0.3887	0.3836		0.3912	0.3917		0.3978	0.3958		0.3950	0.3875
5D1	0.3783	0.3646	5D2	0.3804	0.3721	5D3	0.3863	0.3758	5D4	0.3840	0.3681
	0.3804	0.3721		0.3825	0.3798		0.3887	0.3836		0.3863	0.3758
	0.3863	0.3758		0.3887	0.3836		0.3950	0.3875		0.3924	0.3794
	0.3840	0.3681		0.3863	0.3758		0.3924	0.3794		0.3898	0.3716
5R	0.3670	0.3578	5S	0.3771	0.4034	5T	0.3916	0.4127	5U	0.3783	0.3646
	0.3783	0.3646		0.3916	0.4127		0.4064	0.4221		0.3898	0.3716
	0.3743	0.3502		0.3869	0.3958		0.4006	0.4044		0.3848	0.3565
	0.3640	0.3440		0.3736	0.3874		0.3869	0.3958		0.3743	0.3502
6A	0.3941	0.3848	6B	0.3996	0.4015	6C	0.4146	0.4089	6D	0.4080	0.3916
	0.4080	0.3916		0.4146	0.4089		0.4299	0.4165		0.4221	0.3985
	0.4017	0.3752		0.4080	0.3916		0.4221	0.3985		0.4147	0.3814
	0.3889	0.369		0.3941	0.3848		0.4080	0.3916		0.4017	0.3752
6A1	0.3889	0.3690	6A2	0.3915	0.3768	6A3	0.3981	0.3800	6A4	0.4080	0.3916
	0.3915	0.3768		0.3941	0.3848		0.4010	0.3882		0.3981	0.3800
	0.3981	0.3800		0.4010	0.3882		0.4080	0.3916		0.4048	0.3832
	0.3953	0.3720		0.3981	0.3800		0.4048	0.3832		0.4017	0.3751
6B1	0.3941	0.3848	6B2	0.3968	0.3930	6B3	0.4040	0.3966	6B4	0.4010	0.3882
	0.3968	0.3930		0.3996	0.4015		0.4071	0.4052		0.4040	0.3966
	0.4040	0.3966		0.4071	0.4052		0.4146	0.4089		0.4113	0.4001
	0.4010	0.3882		0.4040	0.3966		0.4113	0.4001		0.4080	0.3916
6C1	0.4080	0.3916	6C2	0.4113	0.4001	6C3	0.4186	0.4037	6C4	0.4150	0.3950
	0.4113	0.4001		0.4146	0.4089		0.4222	0.4127		0.4186	0.4037
	0.4186	0.4037		0.4222	0.4127		0.4299	0.4165		0.4259	0.4073
	0.4150	0.3950		0.4186	0.4037		0.4259	0.4073		0.4221	0.3984

**PERFORMANCE GROUPS – CHROMATICITY (CONTINUED)**

Region	x	y	Region	x	y	Region	x	y	Region	x	y
6D1	0.4017	0.3751	6D2	0.4048	0.3832	6D3	0.4116	0.3865	6D4	0.4082	0.3782
	0.4048	0.3832		0.4080	0.3916		0.4150	0.3950		0.4116	0.3865
	0.4116	0.3865		0.4150	0.3950		0.4221	0.3984		0.4183	0.3898
	0.4082	0.3782		0.4116	0.3865		0.4183	0.3898		0.4147	0.3814
6R	0.3889	0.3690	6S	0.4054	0.4191	6T	0.4217	0.4273	6U	0.4017	0.3751
	0.4017	0.3751		0.4217	0.4273		0.4382	0.4356		0.4147	0.3814
	0.3957	0.3596		0.4146	0.4089		0.4299	0.4165		0.4077	0.3652
	0.3840	0.3540		0.3996	0.4015		0.4146	0.4089		0.3957	0.3596
7A	0.4221	0.3985	7B	0.4299	0.4165	7C	0.4430	0.4212	7D	0.4342	0.4028
	0.4342	0.4028		0.4430	0.4212		0.4562	0.426		0.4465	0.4071
	0.4260	0.3853		0.4342	0.4028		0.4465	0.4071		0.4373	0.3893
	0.4147	0.3814		0.4221	0.3985		0.4342	0.4028		0.4260	0.3853
7A1	0.4147	0.3814	7A2	0.4183	0.3898	7A3	0.4242	0.3919	7A4	0.4203	0.3833
	0.4183	0.3898		0.4221	0.3984		0.4281	0.4006		0.4242	0.3919
	0.4242	0.3919		0.4281	0.4006		0.4342	0.4028		0.4300	0.3939
	0.4203	0.3833		0.4242	0.3919		0.4300	0.3939		0.4259	0.3853
7B1	0.4221	0.3984	7B2	0.4259	0.4073	7B3	0.4322	0.4096	7B4	0.4281	0.4006
	0.4259	0.4073		0.4299	0.4165		0.4364	0.4188		0.4322	0.4096
	0.4322	0.4096		0.4364	0.4188		0.4430	0.4212		0.4385	0.4119
	0.4281	0.4006		0.4322	0.4096		0.4385	0.4119		0.4342	0.4028
7C1	0.4342	0.4028	7C2	0.4385	0.4119	7C3	0.4449	0.4141	7C4	0.4403	0.4049
	0.4385	0.4119		0.4430	0.4212		0.4496	0.4236		0.4449	0.4141
	0.4449	0.4141		0.4496	0.4236		0.4562	0.4260		0.4513	0.4164
	0.4403	0.4049		0.4449	0.4141		0.4513	0.4164		0.4465	0.4071
7D1	0.4259	0.3853	7D2	0.4300	0.3939	7D3	0.4359	0.3960	7D4	0.4316	0.3873
	0.4300	0.3939		0.4342	0.4028		0.4403	0.4049		0.4359	0.3960
	0.4359	0.3960		0.4403	0.4049		0.4465	0.4071		0.4418	0.3981
	0.4316	0.3873		0.4359	0.3960		0.4418	0.3981		0.4373	0.3893
8A	0.4465	0.4071	8B	0.4562	0.4260	8C	0.4687	0.4289	8D	0.4582	0.4099
	0.4582	0.4099		0.4687	0.4289		0.4813	0.4319		0.4700	0.4126
	0.4483	0.3918		0.4582	0.4099		0.4700	0.4126		0.4593	0.3944
	0.4373	0.3893		0.4465	0.4071		0.4582	0.4099		0.4483	0.3918
8A1	0.4373	0.3893	8A2	0.4418	0.3981	8A3	0.4475	0.3994	8A4	0.4428	0.3906
	0.4418	0.3981		0.4465	0.4071		0.4523	0.4085		0.4475	0.3994
	0.4475	0.3994		0.4523	0.4085		0.4582	0.4099		0.4532	0.4008
	0.4428	0.3906		0.4475	0.3994		0.4532	0.4008		0.4483	0.3919
8B1	0.4465	0.4071	8B2	0.4513	0.4164	8B3	0.4573	0.4178	8B4	0.4523	0.4085
	0.4513	0.4164		0.4562	0.4260		0.4624	0.4274		0.4573	0.4178
	0.4573	0.4178		0.4624	0.4274		0.4687	0.4289		0.4634	0.4193
	0.4523	0.4085		0.4573	0.4178		0.4634	0.4193		0.4582	0.4099

**PERFORMANCE GROUPS – CHROMATICITY (CONTINUED)**

Region	x	y	Region	x	y	Region	x	y	Region	x	y
8C1	0.4582	0.4158	8C2	0.4634	0.4193	8C3	0.4695	0.4207	8C4	0.4641	0.4112
	0.4634	0.4252		0.4687	0.4289		0.4750	0.4304		0.4695	0.4207
	0.4695	0.4250		0.4750	0.4304		0.4813	0.4319		0.4756	0.4221
	0.4641	0.4156		0.4695	0.4207		0.4756	0.4221		0.4700	0.4126
8D1	0.4483	0.3919	8D2	0.4532	0.4008	8D3	0.4589	0.4021	8D4	0.4538	0.3931
	0.4532	0.4008		0.4582	0.4099		0.4641	0.4112		0.4589	0.4021
	0.4589	0.4021		0.4641	0.4112		0.4700	0.4126		0.4646	0.4034
	0.4538	0.3931		0.4589	0.4021		0.4646	0.4034		0.4593	0.3944
9A1	0.4647	0.4035	9A2	0.4700	0.4126	9A3	0.4762	0.4135	9A4	0.4706	0.4043
	0.4706	0.4043		0.4761	0.4135		0.4823	0.4144		0.4765	0.4051
	0.4650	0.3951		0.4706	0.4043		0.4765	0.4051		0.4708	0.3959
	0.4593	0.3944		0.4647	0.4035		0.4706	0.4043		0.4650	0.3951
9B1	0.4757	0.4222	9B2	0.4813	0.4319	9B3	0.4762	0.4135	9B4	0.4819	0.4231
	0.4819	0.4231		0.4877	0.4327		0.4942	0.4335		0.4882	0.4239
	0.4762	0.4135		0.4819	0.4231		0.4882	0.4239		0.4823	0.4144
	0.4700	0.4126		0.4757	0.4223		0.4819	0.4231		0.4725	0.4135
9C1	0.4882	0.4239	9C2	0.4942	0.4335	9C3	0.5006	0.4342	9C4	0.4945	0.4248
	0.4945	0.4248		0.5006	0.4342		0.5070	0.4350		0.5008	0.4256
	0.4885	0.4153		0.4945	0.4248		0.5008	0.4256		0.4946	0.4162
	0.4823	0.4144		0.4882	0.4239		0.4945	0.4248		0.4885	0.4153
9D1	0.4765	0.4051	9D2	0.4823	0.4144	9D3	0.4885	0.4153	9D4	0.4765	0.4051
	0.4825	0.4059		0.4885	0.4153		0.4946	0.4162		0.4825	0.4059
	0.4765	0.3966		0.4825	0.4059		0.4884	0.4068		0.4765	0.3966
	0.4708	0.3959		0.4765	0.4051		0.4825	0.4059		0.4706	0.3959
AA1	0.4822	0.3973	AA2	0.4884	0.4067	AA3	0.4942	0.4066	AA4	0.4879	0.3972
	0.4884	0.4067		0.4946	0.4162		0.5006	0.4160		0.4942	0.4066
	0.4942	0.4066		0.5006	0.4160		0.5066	0.4158		0.5001	0.4064
	0.4879	0.3972		0.4942	0.4066		0.5001	0.4064		0.4936	0.3970
AB1	0.4946	0.4162	AB2	0.5008	0.4256	AB3	0.5069	0.4254	AB4	0.5006	0.4160
	0.5008	0.4256		0.5070	0.4350		0.5133	0.4348		0.5069	0.4254
	0.5069	0.4254		0.5133	0.4348		0.5196	0.4346		0.5131	0.4252
	0.5006	0.4160		0.5069	0.4254		0.5131	0.4252		0.5066	0.4158
AC1	0.5066	0.4067	AC2	0.5131	0.4252	AC3	0.5192	0.4250	AC4	0.5126	0.4156
	0.5131	0.4162		0.5196	0.4346		0.5258	0.4343		0.5192	0.4250
	0.5192	0.4160		0.5258	0.4343		0.5321	0.4341		0.5253	0.4248
	0.5126	0.4066		0.5192	0.4250		0.5253	0.4248		0.5186	0.4154
AD1	0.4936	0.3970	AD2	0.5001	0.4064	AD3	0.5059	0.4062	AD4	0.4993	0.3969
	0.5001	0.4064		0.5066	0.4158		0.5126	0.4156		0.5059	0.4062
	0.5059	0.4062		0.5126	0.4156		0.5186	0.4154		0.5118	0.4061
	0.4993	0.3969		0.5059	0.4062		0.5118	0.4061		0.5050	0.3967



## CREE'S STANDARD WHITE CHROMATICITY REGIONS PLOTTED ON THE CIE 1931 CURVE

### ANSI Cool White

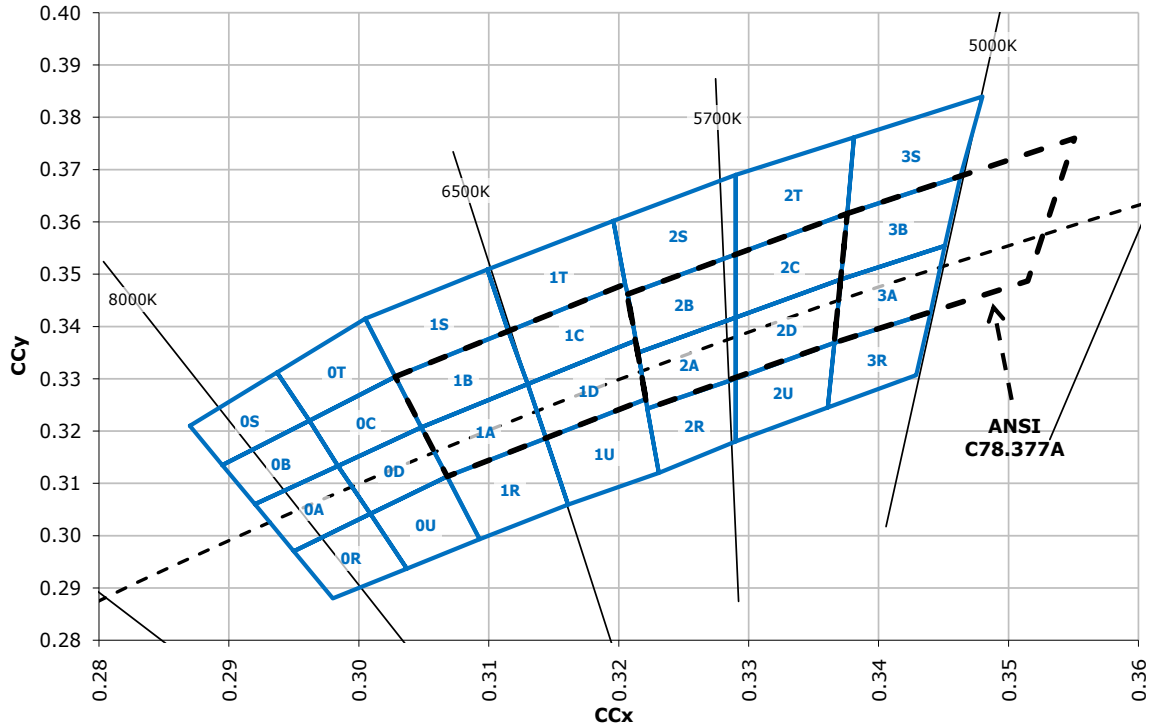

### ANSI Neutral White and ANSI Warm White - XT-E & 48-V XT-E HVW

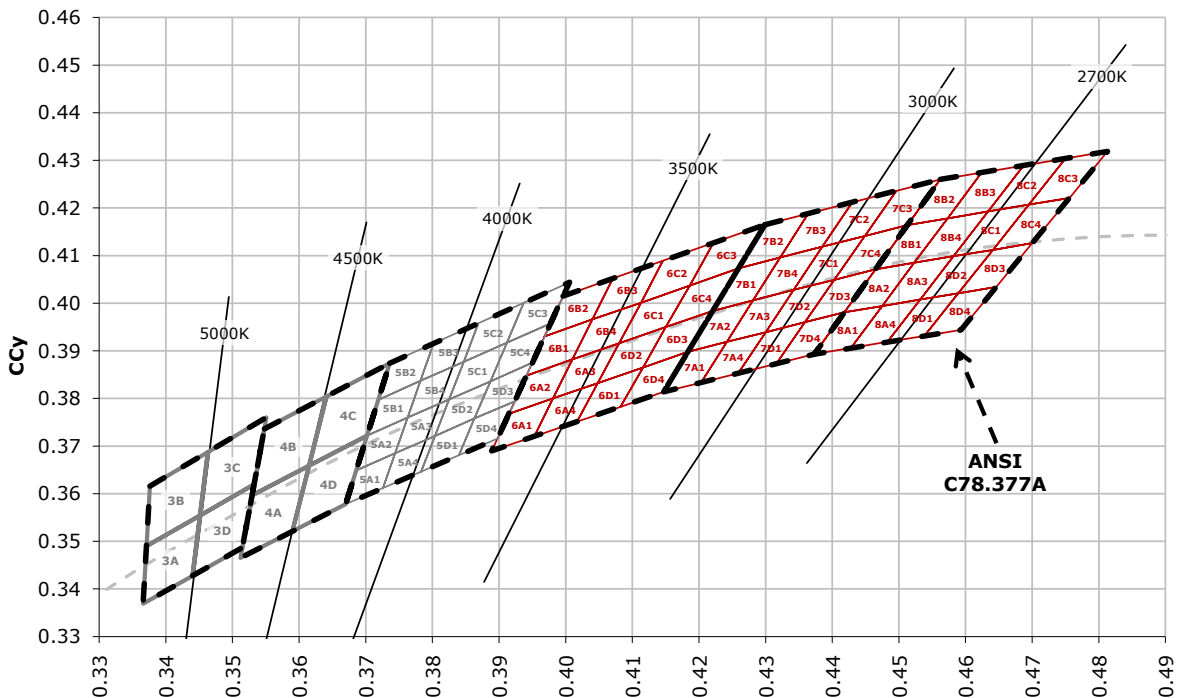

## CREE'S STANDARD WHITE CHROMATICITY REGIONS PLOTTED ON THE CIE 1931 CURVE - CONTINUED

ANSI Neutral White and ANSI Warm White - 12-V & 24-V XT-E HVW

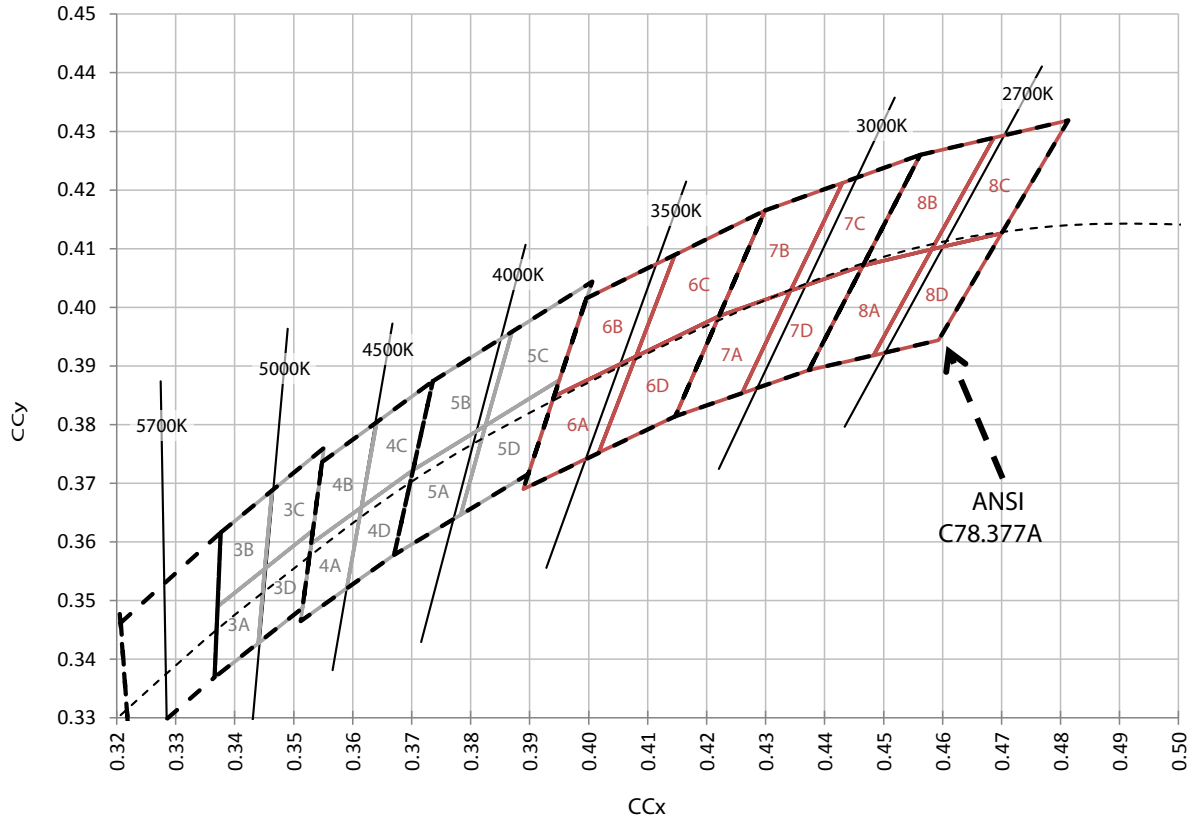

### CREE'S STANDARD COOL WHITE KITS PLOTTED ON ANSI STANDARD CHROMATICITY REGIONS

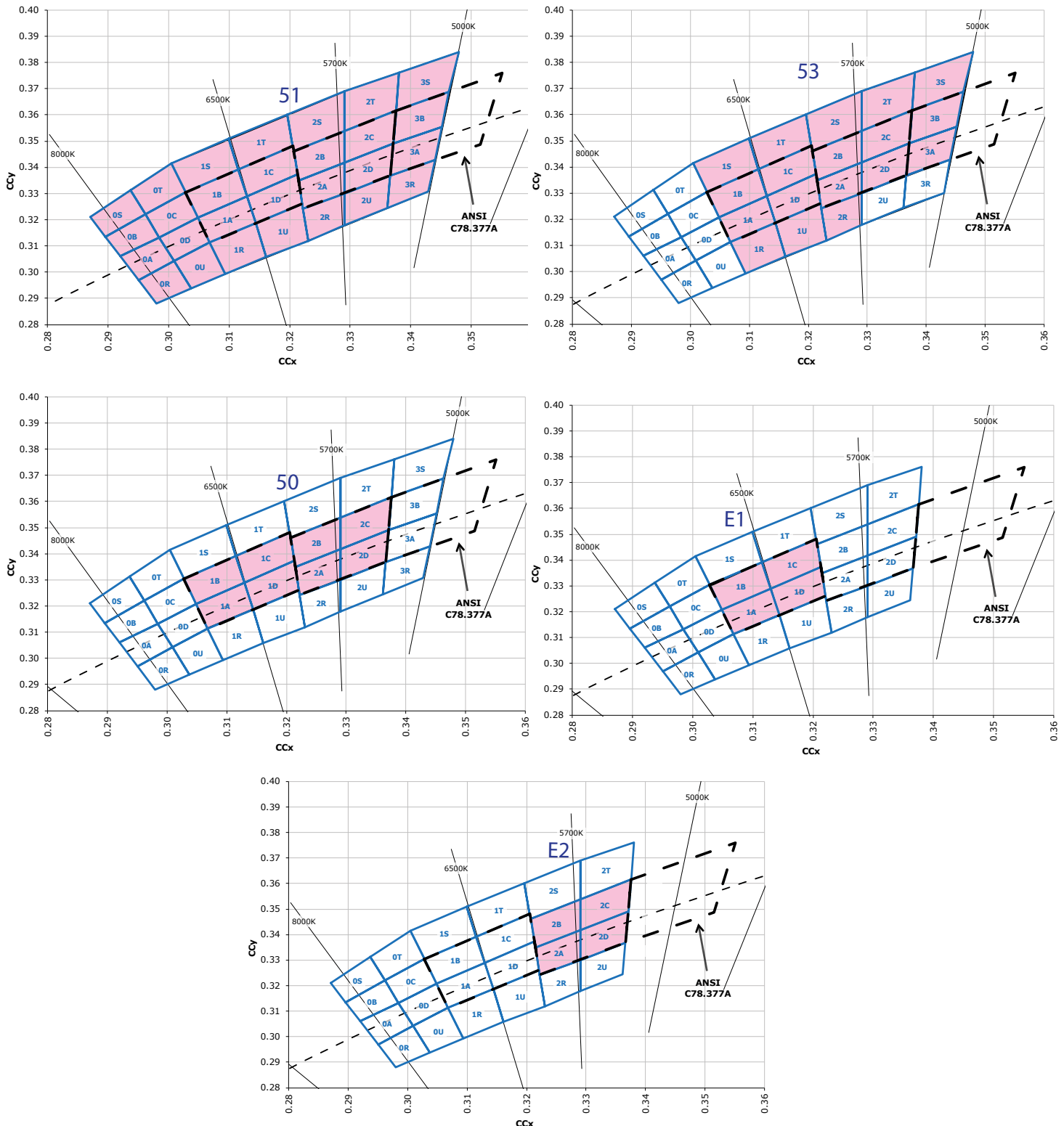

### CREE'S OUTDOOR WHITE KITS PLOTTED ON ANSI STANDARD CHROMATICITY REGIONS

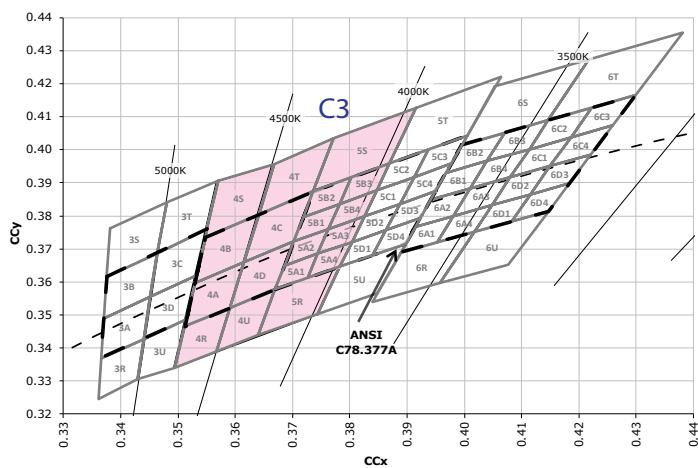
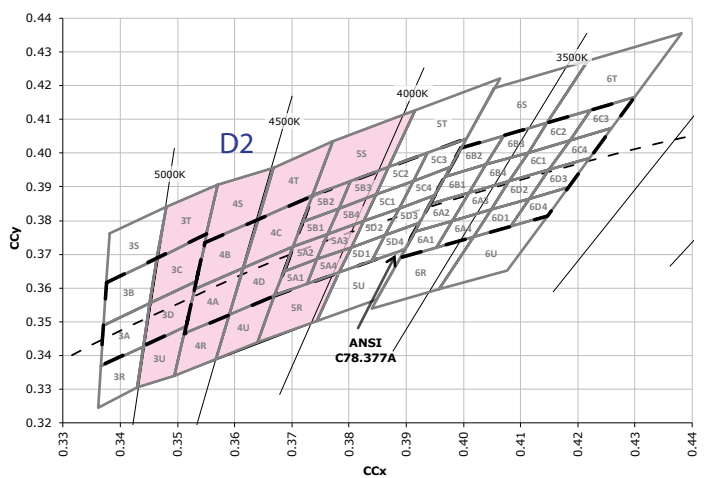
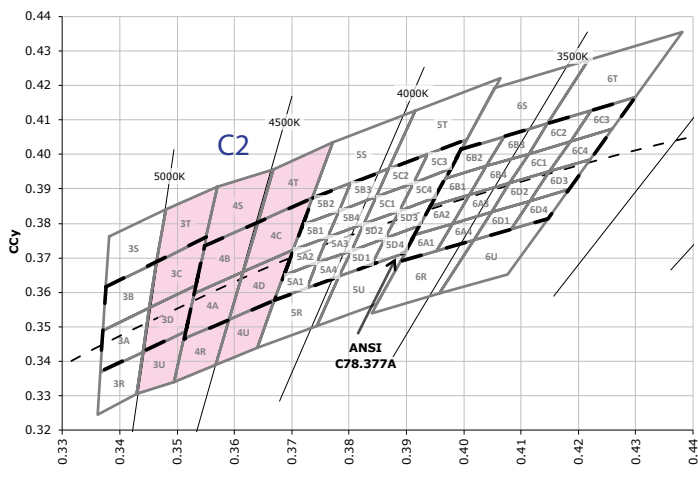
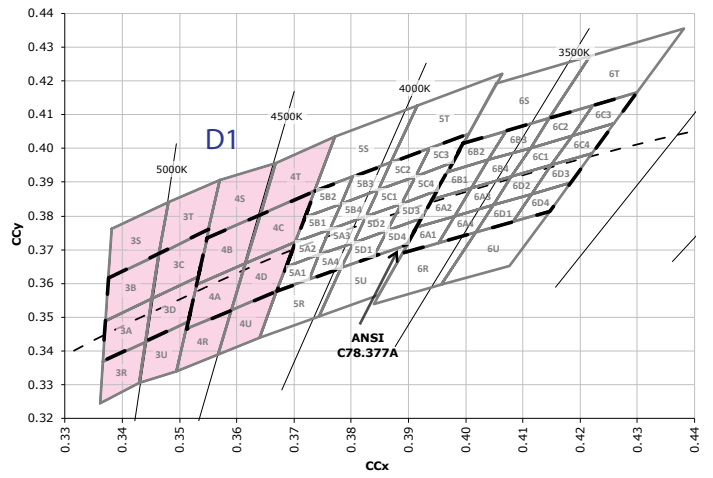
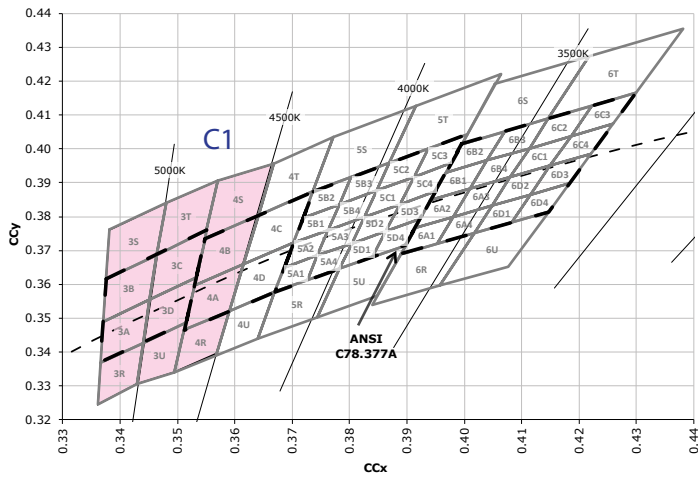

## CREE'S STANDARD WARM AND NEUTRAL WHITE KITS PLOTTED ON ANSI STANDARD CHROMATICITY REGIONS

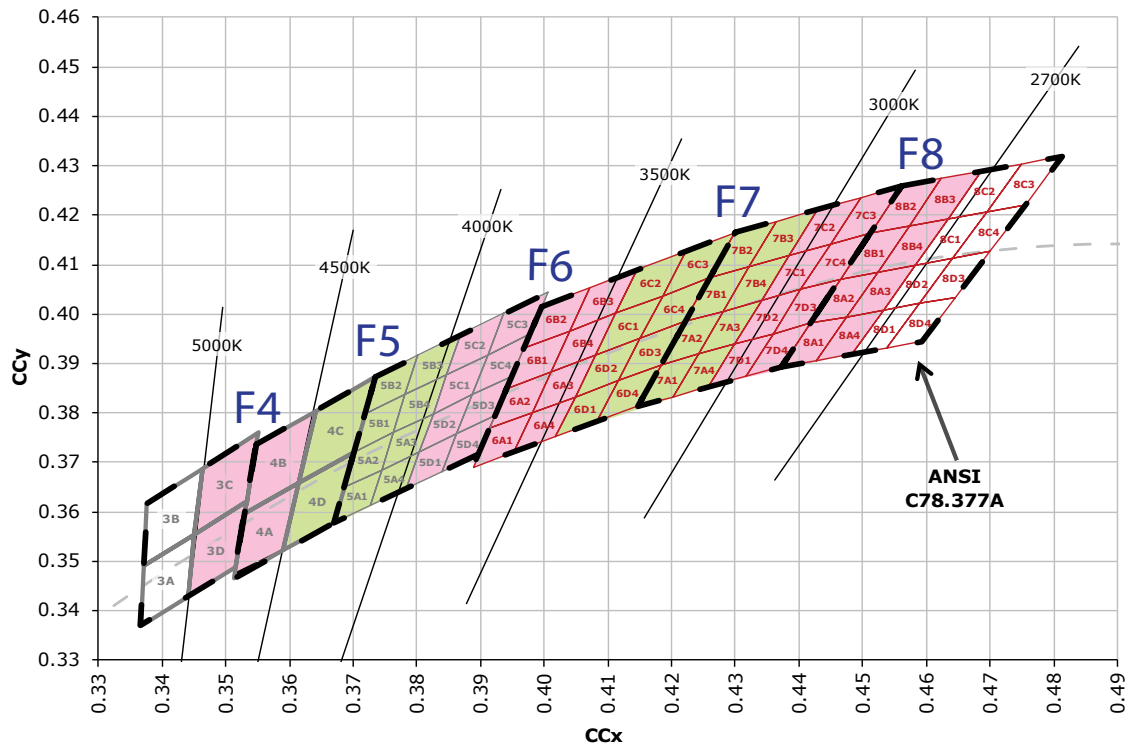
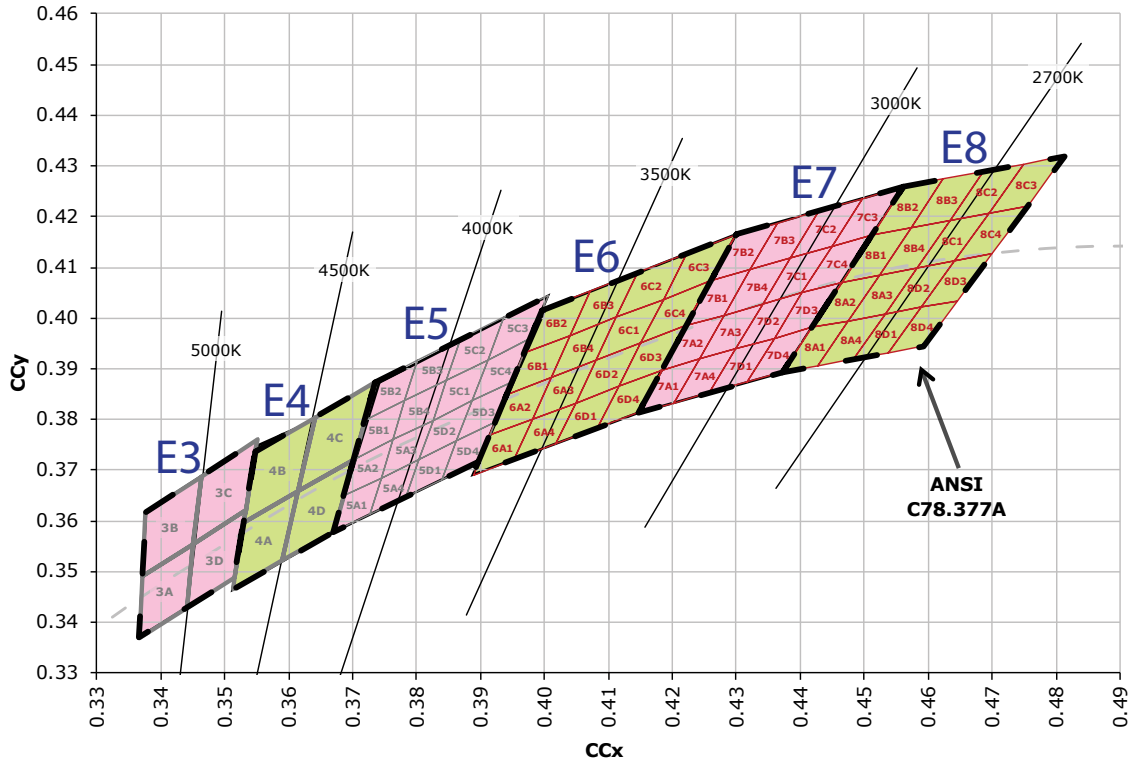

### CREE'S 2450 K & 2200 K CCT WHITE KITS PLOTTED ON ANSI STANDARD CHROMATICITY REGIONS

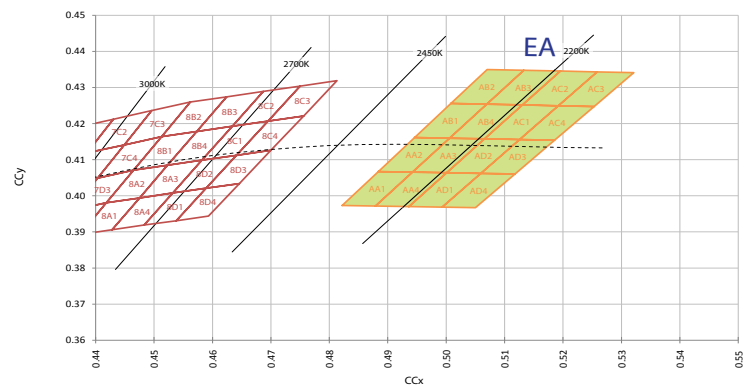
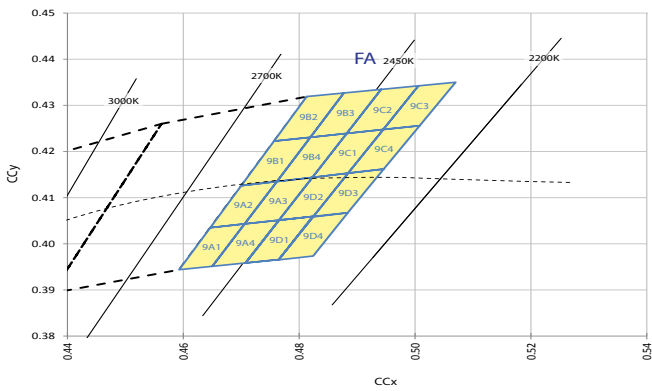
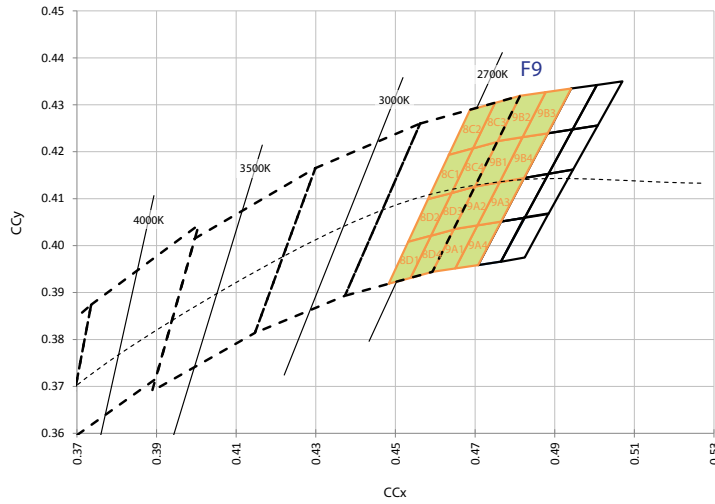

**CREE'S STANDARD CHROMATICITY KITS**

The following table provides the chromaticity bins associated with chromaticity kits for XT-E LEDs.

Color	CCT	Kit	Chromaticity Bins
Cool White	6200 K	51	0A, 0B, 0C, 0D, 0R, 0S, 0T, 0U, 1A, 1B, 1C, 1D, 1R, 1S, 1T, 1U, 2A, 2B, 2C, 2D, 2R, 2S, 2T, 2U, 3A, 3B, 3R, 3S
	6000 K	53	1A, 1B, 1C, 1D, 1R, 1S, 1T, 1U, 2A, 2B, 2C, 2D, 2R, 2S, 2T, 3A, 3B, 3S
	6200 K	50	1A, 1B, 1C, 1D, 2A, 2B, 2C, 2D
	6500 K	E1	1A, 1B, 1C, 1D
	5700 K	E2	2A, 2B, 2C, 2D
Neutral White	5000 K	E3	3A, 3B, 3C, 3D
	5000 K	C1	3A, 3B, 3C, 3D, 3R, 3S, 3T, 3U, 4A, 4B, 4R, 4S
	4750 K	F4	3C, 3D, 4A, 4B
	4750 K	D1	3A, 3B, 3C, 3D, 3R, 3S, 3T, 3U, 4A, 4B, 4C, 4D, 4R, 4S, 4T, 4U
	4500 K	E4	4A, 4B, 4C, 4D
	4500 K	D2	3C, 3D, 3T, 3U, 4A, 4B, 4C, 4D, 4R, 4S, 4T, 4U, 5A1, 5A2, 5A3, 5A4, 5B1, 5B2, 5B3, 5B4, 5R, 5S
	4500 K	C2	3C, 3D, 3T, 3U, 4A, 4B, 4C, 4D, 4R, 4S, 4T, 4U
	4300 K	C3	4A, 4B, 4C, 4D, 4R, 4S, 4T, 4U, 5A1, 5A2, 5A3, 5A4, 5B1, 5B2, 5B3, 5B4, 5R, 5S
	4250 K	F5	4C, 4D, 5A1, 5A2, 5A3, 5A4, 5B1, 5B2, 5B3, 5B4
4000 K	E5	5A1, 5A2, 5A3, 5A4, 5B1, 5B2, 5B3, 5B4, 5C1, 5C2, 5C3, 5C4, 5D1, 5D2, 5D3, 5D4	
Warm White	3750 K	F6	5C1, 5C2, 5C3, 5C4, 5D1, 5D2, 5D3, 5D4, 6A1, 6A2, 6A3, 6A4, 6B1, 6B2, 6B3, 6B4
	3500 K	E6	6A1, 6A2, 6A3, 6A4, 6B1, 6B2, 6B3, 6B4, 6C1, 6C2, 6C3, 6C4, 6D1, 6D2, 6D3, 6D4
	3250 K	F7	6C1, 6C2, 6C3, 6C4, 6D1, 6D2, 6D3, 6D4, 7A1, 7A2, 7A3, 7A4, 7B1, 7B2, 7B3, 7B4
	3000 K	E7	7A1, 7A2, 7A3, 7A4, 7B1, 7B2, 7B3, 7B4, 7C1, 7C2, 7C3, 7C4, 7D1, 7D2, 7D3, 7D4
	2850 K	F8	7C1, 7C2, 7C3, 7C4, 7D1, 7D2, 7D3, 7D4, 8A1, 8A2, 8A3, 8A4, 8B1, 8B2, 8B3, 8B4
	2700 K	E8	8A1, 8A2, 8A3, 8A4, 8B1, 8B2, 8B3, 8B4, 8C1, 8C2, 8C3, 8C4, 8D1, 8D2, 8D3, 8D4
	2200 K	EA	AA1, AA2, AA3, AA4, AB1, AB2, AB3, AB4, AC1, AC2, AC3, AC4, AD1, AD2, AD3, AD4

The following table provides the chromaticity bins associated with chromaticity kits for 12-V XT-E HVW LEDs.

Color	CCT	Kit	Chromaticity Bins
Warm White	3000 K	E7	7A, 7B, 7C, 7D
	2850 K	F8	7C, 7D, 8A, 8B
	2700 K	E8	8A, 8B, 8C, 8D

The following table provides the chromaticity bins associated with chromaticity kits for 24-V XT-E HVW LEDs.

Color	CCT	Kit	Chromaticity Bins
Neutral White	5000 K	E3	3A, 3B, 3C, 3D
	4750 K	F4	3C, 3D, 4A, 4B
Warm White	3000 K	E7	7A, 7B, 7C, 7D
	2850 K	F8	7C, 7D, 8A, 8B
	2700 K	E8	8A, 8B, 8C, 8D

- Notes:
- Cree maintains a tolerance of  $\pm 7\%$  on flux and power measurements,  $\pm 0.005$  on chromaticity (CCx, CCy) measurements and  $\pm 2$  on CRI measurements.
  - Cree XLamp XT LED Family order codes specify only a minimum flux bin and not a maximum. Cree may ship reels in flux bins higher than the minimum specified by the order code without advance notice. Shipments will always adhere to the chromaticity or DWL bin restrictions specified by the order code

The following table provides the chromaticity bins associated with chromaticity kits for 48-V XT-E HVW LEDs.

Color	CCT	Kit	Chromaticity Bins
Cool White	6200 K	51	0A, 0B, 0C, 0D, 0R, 0S, 0T, 0U, 1A, 1B, 1C, 1D, 1R, 1S, 1T, 1U, 2A, 2B, 2C, 2D, 2R, 2S, 2T, 2U, 3A, 3B, 3R, 3S
	6000 K	53	1A, 1B, 1C, 1D, 1R, 1S, 1T, 1U, 2A, 2B, 2C, 2D, 2R, 2S, 2T, 3A, 3B, 3S
	6200 K	50	1A, 1B, 1C, 1D, 2A, 2B, 2C, 2D
	6500 K	E1	1A, 1B, 1C, 1D
	5700 K	E2	2A, 2B, 2C, 2D
Neutral White	5000 K	E3	3A, 3B, 3C, 3D
	4750 K	F4	3C, 3D, 4A, 4B
	4500 K	E4	4A, 4B, 4C, 4D
	4500 K	C2	3C, 3D, 3T, 3U, 4A, 4B, 4C, 4D, 4R, 4S, 4T, 4U
	4250 K	F5	4C, 4D, 5A1, 5A2, 5A3, 5A4, 5B1, 5B2, 5B3, 5B4
4000 K	E5	5A1, 5A2, 5A3, 5A4, 5B1, 5B2, 5B3, 5B4, 5C1, 5C2, 5C3, 5C4, 5D1, 5D2, 5D3, 5D4	
Warm White	3750 K	F6	5C1, 5C2, 5C3, 5C4, 5D1, 5D2, 5D3, 5D4, 6A1, 6A2, 6A3, 6A4, 6B1, 6B2, 6B3, 6B4
	3500 K	E6	6A1, 6A2, 6A3, 6A4, 6B1, 6B2, 6B3, 6B4, 6C1, 6C2, 6C3, 6C4, 6D1, 6D2, 6D3, 6D4
	3250 K	F7	6C1, 6C2, 6C3, 6C4, 6D1, 6D2, 6D3, 6D4, 7A1, 7A2, 7A3, 7A4, 7B1, 7B2, 7B3, 7B4
	3000 K	E7	7A1, 7A2, 7A3, 7A4, 7B1, 7B2, 7B3, 7B4, 7C1, 7C2, 7C3, 7C4, 7D1, 7D2, 7D3, 7D4
	2850 K	F8	7C1, 7C2, 7C3, 7C4, 7D1, 7D2, 7D3, 7D4, 8A1, 8A2, 8A3, 8A4, 8B1, 8B2, 8B3, 8B4
	2700 K	E8	8A1, 8A2, 8A3, 8A4, 8B1, 8B2, 8B3, 8B4, 8C1, 8C2, 8C3, 8C4, 8D1, 8D2, 8D3, 8D4
	2700 K	F9	8C1, 8C2, 8C3, 8C4, 8D1, 8D2, 8D3, 8D, 9A1, 9A2, 9A3, 9A4, 9B1, 9B2, 9B3, 9B4
	2450 K	FA	9A1, 9A2, 9A3, 9A4, 9B1, 9B2, 9B3, 9B4, 9C1, 9C2, 9C3, 9C4, 9D1, 9D2, 9D3, 9D4
	2200 K	EA	AA1, AA2, AA3, AA4, AB1, AB2, AB3, AB4, AC1, AC2, AC3, AC4, AD1, AD2, AD3, AD4

- Notes:
- Cree maintains a tolerance of  $\pm 7\%$  on flux and power measurements,  $\pm 0.005$  on chromaticity (CCx, CCy) measurements and  $\pm 2$  on CRI measurements.
  - Cree XLamp XT LED Family order codes specify only a minimum flux bin and not a maximum. Cree may ship reels in flux bins higher than the minimum specified by the order code without advance notice. Shipments will always adhere to the chromaticity or DWL bin restrictions specified by the order code



The following tables of order codes list flux minimums and chromaticity regions for the various categories of XLamp XT LEDs. For other flux and chromaticity combinations, contact Cree or an authorized distributor.

**STANDARD ORDER CODES AND BINS (XT-E ANSI COOL WHITE,  $T_j = 85\text{ }^\circ\text{C}$ )**

XLamp XT-E LED Standard Kit Codes - White						
Chromaticity		Minimum Luminous Flux (lm) @ 350 mA*		Order Codes		
Kit	CCT	Code	Flux (lm)	No Minimum CRI	70 CRI Minimum	80 CRI Minimum
ANSI Cool White (5000 K - 8300 K)						
51	6200 K	R5	139	XTEAWT-00-0000-000000H51	XTEAWT-00-0000-00000BH51	
		R4	130	XTEAWT-00-0000-000000G51	XTEAWT-00-0000-00000BG51	XTEAWT-00-0000-00000HG51
		R3	122	XTEAWT-00-0000-000000F51	XTEAWT-00-0000-00000BF51	XTEAWT-00-0000-00000HF51
		R2	114	XTEAWT-00-0000-000000E51	XTEAWT-00-0000-00000BE51	XTEAWT-00-0000-00000HE51
		Q5	107			XTEAWT-00-0000-00000HD51
53	6000 K	R5	139	XTEAWT-00-0000-000000H53	XTEAWT-00-0000-00000BH53	
		R4	130	XTEAWT-00-0000-000000G53	XTEAWT-00-0000-00000BG53	XTEAWT-00-0000-00000HG53
		R3	122	XTEAWT-00-0000-000000F53	XTEAWT-00-0000-00000BF53	XTEAWT-00-0000-00000HF53
		R2	114	XTEAWT-00-0000-000000E53	XTEAWT-00-0000-00000BE53	XTEAWT-00-0000-00000HE53
		Q5	107			XTEAWT-00-0000-00000HD53
50	6200 K	R5	139	XTEAWT-00-0000-000000H50	XTEAWT-00-0000-00000BH50	
		R4	130	XTEAWT-00-0000-000000G50	XTEAWT-00-0000-00000BG50	XTEAWT-00-0000-00000HG50
		R3	122	XTEAWT-00-0000-000000F50	XTEAWT-00-0000-00000BF50	XTEAWT-00-0000-00000HF50
		R2	114	XTEAWT-00-0000-000000E50	XTEAWT-00-0000-00000BE50	XTEAWT-00-0000-00000HE50
		Q5	107			XTEAWT-00-0000-00000HD50
E1	6500 K	R5	139	XTEAWT-00-0000-000000HE1	XTEAWT-00-0000-00000BHE1	
		R4	130	XTEAWT-00-0000-000000GE1	XTEAWT-00-0000-00000BGE1	XTEAWT-00-0000-00000HGE1
		R3	122	XTEAWT-00-0000-000000FE1	XTEAWT-00-0000-00000BFE1	XTEAWT-00-0000-00000HFE1
		R2	114	XTEAWT-00-0000-000000EE1	XTEAWT-00-0000-00000BEE1	XTEAWT-00-0000-00000HEE1
		Q5	107			XTEAWT-00-0000-00000HDE1
E2	5700 K	R5	139	XTEAWT-00-0000-000000HE2	XTEAWT-00-0000-00000BHE2	
		R4	130	XTEAWT-00-0000-000000GE2	XTEAWT-00-0000-00000BGE2	XTEAWT-00-0000-00000HGE2
		R3	122	XTEAWT-00-0000-000000FE2	XTEAWT-00-0000-00000BFE2	XTEAWT-00-0000-00000HFE2
		R2	114	XTEAWT-00-0000-000000EE2	XTEAWT-00-0000-00000BEE2	XTEAWT-00-0000-00000HEE2
		Q5	107			XTEAWT-00-0000-00000HDE2

- Notes:
- Cree maintains a tolerance of  $\pm 7\%$  on flux and power measurements,  $\pm 0.005$  on chromaticity (CCx, CCy) measurements and  $\pm 2$  on CRI measurements.
  - Cree XLamp XT LED Family order codes specify only a minimum flux bin and not a maximum. Cree may ship reels in flux bins higher than the minimum specified by the order code without advance notice. Shipments will always adhere to the chromaticity or DWL bin restrictions specified by the order code

**STANDARD ORDER CODES AND BINS (XT-E NEUTRAL WHITE, T<sub>j</sub> = 85 °C)**

XLamp XT-E LED Standard Kit Codes - White										
Chromaticity		Minimum Luminous Flux (lm) @ 350 mA*		Order Codes XTEAWT-00- (+ extensions below)						
Kit	CCT	Code	Flux (lm)	No Minimum CRI	70 CRI Minimum	75 CRI Typical	80 CRI Minimum	85 CRI Minimum	90 CRI Minimum	
ANSI Neutral White (3700 K – 5000 K)										
E3	5000 K	R5	139	0000-000000HE3	0000-000000BHE3					
		R4	130	0000-000000GE3	0000-000000BGE3	0000-000000LGE3	0000-000000HGE3			
		R3	122	0000-000000FE3	0000-000000BFE3	0000-000000LFE3	0000-000000HFE3			
		R2	114	0000-000000EE3	0000-000000BEE3	0000-000000LEE3	0000-000000HEE3			
		Q5	107				0000-000000HDE3			
		Q4	100					0000-000000PCE3	0000-000000UCE3	
		Q3	93.9					0000-000000PBE3	0000-000000UBE3	
		Q2	87.4					0000-000000PAE3	0000-000000UAE3	
C1	5000 K	R5	139	0000-000000HC1	0000-000000BHC1					
		R4	130	0000-000000GC1	0000-000000BGC1	0000-000000LGC1				
		R3	122	0000-000000FC1	0000-000000BFC1	0000-000000LFC1				
		R2	114	0000-000000EC1	0000-000000BEC1	0000-000000LEC1				
F4	4750 K	R5	139	0000-000000HF4	0000-000000BHF4					
		R4	130	0000-000000GF4	0000-000000BGF4	0000-000000LGF4				
		R3	122	0000-000000FF4	0000-000000BFF4	0000-000000LFF4	0000-000000HFF4			
		R2	114	0000-000000EF4	0000-000000BEF4	0000-000000LEF4	0000-000000HEF4			
		Q5	107			0000-000000LDF4	0000-000000HDF4			
		Q4	100					0000-000000PCF4	0000-000000UCF4	
		Q3	93.9					0000-000000PBF4	0000-000000UBF4	
		Q2	87.4					0000-000000PAF4	0000-000000UAF4	
D1	4750 K	R5	139	0000-000000HD1	0000-000000BHD1					
		R4	130	0000-000000GD1	0000-000000BGD1	0000-000000LGD1				
		R3	122	0000-000000FD1	0000-000000BFD1	0000-000000LFD1				
		R2	114	0000-000000ED1	0000-000000BED1	0000-000000LED1				
E4	4500 K	R5	139	0000-000000HE4	0000-000000BHE4					
		R4	130	0000-000000GE4	0000-000000BGE4	0000-000000LGE4				
		R3	122	0000-000000FE4	0000-000000BFE4	0000-000000LFE4	0000-000000HFE4			
		R2	114	0000-000000EE4	0000-000000BEE4	0000-000000LEE4	0000-000000HEE4			
		Q5	107			0000-000000LDE4	0000-000000HDE4			
		Q4	100					0000-000000PCE4	0000-000000UCE4	
		Q3	93.9					0000-000000PBE4	0000-000000UBE4	
		Q2	87.4					0000-000000PAE4	0000-000000UAE4	

- Notes:
- Cree maintains a tolerance of ±7% on flux and power measurements, ±0.005 on chromaticity (CCx, CCy) measurements and ±2 on CRI measurements.
  - Cree XLamp XT LED Family order codes specify only a minimum flux bin and not a maximum. Cree may ship reels in flux bins higher than the minimum specified by the order code without advance notice. Shipments will always adhere to the chromaticity or DWL bin restrictions specified by the order code

**STANDARD ORDER CODES AND BINS (XT-E NEUTRAL WHITE, T<sub>j</sub> = 85 °C) - CONTINUED**

XLamp XT-E LED Standard Kit Codes - White									
Chromaticity		Minimum Luminous Flux (lm) @ 350 mA*		Order Codes XTEAWT-00- (+ extensions below)					
Kit	CCT	Code	Flux (lm)	No Minimum CRI	70 CRI Minimum	75 CRI Typical	80 CRI Minimum	85 CRI Minimum	90 CRI Minimum
ANSI Neutral White (3700 K – 5000 K)									
D2	4500 K	R5	139	0000-000000HD2	0000-000000BHD2				
		R4	130	0000-000000GD2	0000-000000BGD2				
		R3	122	0000-000000FD2	0000-000000BFD2	0000-000000LFD2			
		R2	114	0000-000000ED2	0000-000000BED2	0000-000000LED2			
		Q5	107			0000-000000LDD2			
C2	4500 K	R5	139	0000-000000HC2	0000-000000BHC2				
		R4	130	0000-000000GC2	0000-000000BGC2	0000-000000LGC2			
		R3	122	0000-000000FC2	0000-000000BFC2	0000-000000LFC2			
		R2	114	0000-000000EC2	0000-000000BEC2	0000-000000LEC2			
C3	4300 K	R5	139	0000-000000HC3	0000-000000BHC3				
		R4	130	0000-000000GC3	0000-000000BGC3	0000-000000LGC3			
		R3	122	0000-000000FC3	0000-000000BFC3	0000-000000LFC3			
		R2	114	0000-000000EC3	0000-000000BEC3	0000-000000LEC3			
F5	4250 K	R4	130	0000-000000GF5	0000-000000BGF5				
		R3	122	0000-000000FF5	0000-000000BFF5	0000-000000LFF5	0000-000000HFF5		
		R2	114	0000-000000EF5	0000-000000BEF5	0000-000000LEF5	0000-000000HEF5		
		Q5	107	0000-000000DF5	0000-000000BDF5	0000-000000LDF5	0000-000000HDF5		
		Q4	100			0000-000000LCF5	0000-000000HCF5		
		Q3	93.9					0000-000000PBF5	0000-000000UBF5
		Q2	87.4					0000-000000PAF5	0000-000000UAF5
		P4	80.6					0000-000000P9F5	0000-000000U9F5
E5	4000 K	R4	130	0000-000000GE5	0000-000000BGE5				
		R3	122	0000-000000FE5	0000-000000BFE5	0000-000000LFE5	0000-000000HFE5		
		R2	114	0000-000000EE5	0000-000000BEE5	0000-000000LEE5	0000-000000HEE5		
		Q5	107	0000-000000DE5	0000-000000BDE5	0000-000000LDE5	0000-000000HDE5		
		Q4	100			0000-000000LCE5	0000-000000HCE5		
		Q3	93.9					0000-000000PBE5	0000-000000UBE5
		Q2	87.4					0000-000000PAE5	0000-000000UAE5
		P4	80.6					0000-000000P9E5	0000-000000U9E5

- Notes:
- Cree maintains a tolerance of ±7% on flux and power measurements, ±0.005 on chromaticity (CCx, CCy) measurements and ±2 on CRI measurements.
  - Cree XLamp XT LED Family order codes specify only a minimum flux bin and not a maximum. Cree may ship reels in flux bins higher than the minimum specified by the order code without advance notice. Shipments will always adhere to the chromaticity or DWL bin restrictions specified by the order code

**STANDARD ORDER CODES AND BINS (XT-E WARM WHITE, T<sub>j</sub> = 85 °C)**

XLamp XT-E LED Standard Kit Codes - White									
Chromaticity		Minimum Luminous Flux (lm) @ 350 mA*		Order Codes XTEAWT-00- (+ extensions below)					
Kit	CCT	Code	Flux (lm)	No Minimum CRI	70 CRI Minimum	80 CRI Typical	80 CRI Minimum	85 CRI Minimum	90 CRI Minimum
ANSI Warm White (2200 K - 3750 K)									
F6	3750 K	R3	122	0000-00000FF6	0000-00000BFF6	0000-00000LFF6			
		R2	114	0000-00000EF6	0000-00000BEF6	0000-00000LEF6	0000-00000HEF6		
		Q5	107	0000-00000DF6	0000-00000BDF6	0000-00000LDF6	0000-00000HDF6		
		Q4	100			0000-00000LCF6	0000-00000HCF6		
		Q3	93.9					0000-00000PBF6	0000-00000UBF6
		Q2	87.4					0000-00000PAF6	0000-00000UAF6
		P4	80.6					0000-00000P9F6	0000-00000U9F6
E6	3500 K	R3	122	0000-00000FE6	0000-00000BFE6	0000-00000LFE6			
		R2	114	0000-00000EE6	0000-00000BEE6	0000-00000LEE6	0000-00000HEE6		
		Q5	107	0000-00000DE6	0000-00000BDE6	0000-00000LDE6	0000-00000HDE6		
		Q4	100			0000-00000LCE6	0000-00000HCE6		
		Q3	93.9					0000-00000PBE6	0000-00000UBE6
		Q2	87.4					0000-00000PAE6	0000-00000UAE6
		P4	80.6					0000-00000P9E6	0000-00000U9E6
F7	3250 K	R2	114	0000-00000EF7	0000-00000BEF7	0000-00000LEF7	0000-00000HEF7		
		Q5	107	0000-00000DF7	0000-00000BDF7	0000-00000LDF7	0000-00000HDF7		
		Q4	100	0000-00000CF7	0000-00000BCF7	0000-00000LCF7	0000-00000HCF7		
		Q3	93.9			0000-00000LBF7	0000-00000HBF7		
		Q2	87.4					0000-00000PAF7	0000-00000UAF7
		P4	80.6					0000-00000P9F7	0000-00000U9F7
		P3	73.9					0000-00000P8F7	0000-00000U8F7
E7	3000 K	R2	114	0000-00000EE7	0000-00000BEE7	0000-00000LEE7	0000-00000HEE7		
		Q5	107	0000-00000DE7	0000-00000BDE7	0000-00000LDE7	0000-00000HDE7		
		Q4	100	0000-00000CE7	0000-00000BCE7	0000-00000LCE7	0000-00000HCE7		
		Q3	93.9			0000-00000LBE7	0000-00000HBE7		
		Q2	87.4					0000-00000PAE7	0000-00000UAE7
		P4	80.6					0000-00000P9E7	0000-00000U9E7
		P3	73.9					0000-00000P8E7	0000-00000U8E7
F8	2850 K	Q5	107	0000-00000DF8	0000-00000BDF8	0000-00000LDF8	0000-00000HDF8		
		Q4	100	0000-00000CF8	0000-00000BCF8	0000-00000LCF8	0000-00000HCF8		
		Q3	93.9	0000-00000BF8	0000-00000BBF8	0000-00000LBF8	0000-00000HBF8		
		Q2	87.4			0000-00000LAF8	0000-00000HAF8	0000-00000PAF8	
		P4	80.6					0000-00000P9F8	0000-00000U9F8
		P3	73.9					0000-00000P8F8	0000-00000U8F8

- Notes:
- Cree maintains a tolerance of ±7% on flux and power measurements, ±0.005 on chromaticity (CCx, CCy) measurements and ±2 on CRI measurements.
  - Cree XLamp XT LED Family order codes specify only a minimum flux bin and not a maximum. Cree may ship reels in flux bins higher than the minimum specified by the order code without advance notice. Shipments will always adhere to the chromaticity or DWL bin restrictions specified by the order code

**STANDARD ORDER CODES AND BINS (XT-E WARM WHITE, T<sub>j</sub> = 85 °C) - CONTINUED**

XLamp XT-E LED Standard Kit Codes - White									
Chromaticity		Minimum Luminous Flux (lm) @ 350 mA*		Order Codes XTEAWT-00- (+ extensions below)					
Kit	CCT	Code	Flux (lm)	No Minimum CRI	70 CRI Minimum	80 CRI Typical	80 CRI Minimum	85 CRI Minimum	90 CRI Minimum
ANSI Warm White (2200 K - 3750 K)									
E8	2700 K	Q5	107	0000-000000DE8	0000-00000BDE8	0000-00000LDE8	0000-00000HDE8		
		Q4	100	0000-000000CE8	0000-00000BCE8	0000-00000LCE8	0000-00000HCE8		
		Q3	93.9	0000-000000BE8	0000-00000BBE8	0000-00000LBE8	0000-00000HBE8		
		Q2	87.4			0000-00000LAE8	0000-00000HAE8	0000-00000PAE8	
		P4	80.6					0000-00000P9E8	0000-00000U9E8
		P3	73.9					0000-00000P8E8	0000-00000U8E8
EA	2200 K	Q3	93.9		0000-00000BBEA				
		Q2	87.4		0000-00000BAEA		0000-00000HAEA		
		P4	80.6		0000-00000B9EA		0000-00000H9EA		
		P3	73.9				0000-00000H8EA		

**STANDARD ORDER CODES AND BINS (12-VOLT XT-E HVW WARM WHITE, T<sub>j</sub> = 85 °C)**

XLamp XT-E HVW LED Standard Kit Codes - White					
Chromaticity		Minimum Luminous Flux (lm) @ 88 mA*		Order Codes	
Kit	CCT	Code	Flux (lm)	82 CRI Typical	80 CRI Minimum
ANSI Warm White (2700 K - 3750 K)					
E7	3000 K	Q5	107	XTEHVW-D0-0000-00000LDE7	XTEHVW-D0-0000-00000HDE7
		Q4	100	XTEHVW-D0-0000-00000LCE7	XTEHVW-D0-0000-00000HCE7
		Q3	93.9	XTEHVW-D0-0000-00000LBE7	XTEHVW-D0-0000-00000HBE7
F8	2850 K	Q4	100	XTEHVW-D0-0000-00000LCF8	XTEHVW-D0-0000-00000HCF8
		Q3	93.9	XTEHVW-D0-0000-00000LBF8	XTEHVW-D0-0000-00000HBF8
		Q2	87.4	XTEHVW-D0-0000-00000LAF8	XTEHVW-D0-0000-00000HAF8
E8	2700 K	Q4	100	XTEHVW-D0-0000-00000LCE8	XTEHVW-D0-0000-00000HCE8
		Q3	93.9	XTEHVW-D0-0000-00000LBE8	XTEHVW-D0-0000-00000HBE8
		Q2	87.4	XTEHVW-D0-0000-00000LAE8	XTEHVW-D0-0000-00000HAE8

- Notes:
- Cree maintains a tolerance of ±7% on flux and power measurements, ±0.005 on chromaticity (CCx, CCy) measurements and ±2 on CRI measurements.
  - Cree XLamp XT LED Family order codes specify only a minimum flux bin and not a maximum. Cree may ship reels in flux bins higher than the minimum specified by the order code without advance notice. Shipments will always adhere to the chromaticity or DWL bin restrictions specified by the order code

**STANDARD ORDER CODES AND BINS (24-VOLT XT-E HVW NEUTRAL WHITE, T<sub>j</sub> = 85 °C)**

XLamp XT-E LED Standard Kit Codes - White					
Chromaticity		Minimum Luminous Flux (lm) @ 44 mA*		Order Codes	
Kit	CCT	Code	Flux (lm)	75 CRI Typical	80 CRI Minimum
ANSI Neutral White (3700 K – 5000 K)					
E3	5000 K	R2	114	XTEHVW-H0-0000-00000LEE3	XTEHVW-H0-0000-00000HEE3
		Q5	107	XTEHVW-H0-0000-00000LDE3	XTEHVW-H0-0000-00000HDE3
		Q4	100	XTEHVW-H0-0000-00000LCE3	XTEHVW-H0-0000-00000HCE3
F4	4750 K	R2	114	XTEHVW-H0-0000-00000LEF4	XTEHVW-H0-0000-00000HEF4
		Q5	107	XTEHVW-H0-0000-00000LDF4	XTEHVW-H0-0000-00000HDF4
		Q4	100	XTEHVW-H0-0000-00000LCF4	XTEHVW-H0-0000-00000HCF4

**STANDARD ORDER CODES AND BINS (24-VOLT XT-E HVW WARM WHITE, T<sub>j</sub> = 85 °C)**

XLamp XT-E HVW LED Standard Kit Codes - White					
Chromaticity		Minimum Luminous Flux (lm) @ 44 mA*		Order Codes	
Kit	CCT	Code	Flux (lm)	82 CRI Typical	80 CRI Minimum
ANSI Warm White (2700 K - 3750 K)					
E7	3000 K	Q4	100	XTEHVW-H0-0000-00000LCE7	XTEHVW-H0-0000-00000HCE7
		Q3	93.9	XTEHVW-H0-0000-00000LBE7	XTEHVW-H0-0000-00000HBE7
		Q2	87.4	XTEHVW-H0-0000-00000LAE7	XTEHVW-H0-0000-00000HAE7
F8	2850 K	Q3	93.9	XTEHVW-H0-0000-00000LBF8	XTEHVW-H0-0000-00000HBF8
		Q2	87.4	XTEHVW-H0-0000-00000LAF8	XTEHVW-H0-0000-00000HAF8
		P4	80.6	XTEHVW-H0-0000-00000L9F8	XTEHVW-H0-0000-00000H9F8
E8	2700 K	Q3	93.9	XTEHVW-H0-0000-00000LBE8	XTEHVW-H0-0000-00000HBE8
		Q2	87.4	XTEHVW-H0-0000-00000LAE8	XTEHVW-H0-0000-00000HAE8
		P4	80.6	XTEHVW-H0-0000-00000L9E8	XTEHVW-H0-0000-00000H9E8

- Notes:
- Cree maintains a tolerance of ±7% on flux and power measurements, ±0.005 on chromaticity (CCx, CCy) measurements and ±2 on CRI measurements.
  - Cree XLamp XT LED Family order codes specify only a minimum flux bin and not a maximum. Cree may ship reels in flux bins higher than the minimum specified by the order code without advance notice. Shipments will always adhere to the chromaticity or DWL bin restrictions specified by the order code

**STANDARD ORDER CODES AND BINS (48-VOLT XT-E HVW ANSI COOL WHITE, T<sub>j</sub> = 85 °C)**

XLamp XT-E HVW LED Standard Kit Codes - White				
Chromaticity		Minimum Luminous Flux (lm) @ 22 mA*		Order Codes
Kit	CCT	Code	Flux (lm)	No Minimum CRI
ANSI Cool White (5000 K – 8300 K)				
51	6200 K	R5	139	XTEHVW-Q0-0000-00000LH51
		R4	130	XTEHVW-Q0-0000-00000LG51
		R3	122	XTEHVW-Q0-0000-00000LF51
		R2	114	XTEHVW-Q0-0000-00000LE51
		Q5	107	XTEHVW-Q0-0000-00000LD51
		Q4	100	XTEHVW-Q0-0000-00000LC51
53	6000 K	R5	139	XTEHVW-Q0-0000-00000LH53
		R4	130	XTEHVW-Q0-0000-00000LG53
		R3	122	XTEHVW-Q0-0000-00000LF53
		R2	114	XTEHVW-Q0-0000-00000LE53
		Q5	107	XTEHVW-Q0-0000-00000LD53
		Q4	100	XTEHVW-Q0-0000-00000LC53
50	6200 K	R5	139	XTEHVW-Q0-0000-00000LH50
		R4	130	XTEHVW-Q0-0000-00000LG50
		R3	122	XTEHVW-Q0-0000-00000LF50
		R2	114	XTEHVW-Q0-0000-00000LE50
		Q5	107	XTEHVW-Q0-0000-00000LD50
		Q4	100	XTEHVW-Q0-0000-00000LC50
E1	6500 K	R5	139	XTEHVW-Q0-0000-00000LHE1
		R4	130	XTEHVW-Q0-0000-00000LGE1
		R3	122	XTEHVW-Q0-0000-00000LFE1
		R2	114	XTEHVW-Q0-0000-00000LEE1
		Q5	107	XTEHVW-Q0-0000-00000LDE1
		Q4	100	XTEHVW-Q0-0000-00000LCE1
E2	5700 K	R5	139	XTEHVW-Q0-0000-00000LHE2
		R4	130	XTEHVW-Q0-0000-00000LGE2
		R3	122	XTEHVW-Q0-0000-00000LFE2
		R2	114	XTEHVW-Q0-0000-00000LEE2
		Q5	107	XTEHVW-Q0-0000-00000LDE2
		Q4	100	XTEHVW-Q0-0000-00000LCE2

- Notes:
- Cree maintains a tolerance of ±7% on flux and power measurements, ±0.005 on chromaticity (CCx, CCy) measurements and ±2 on CRI measurements.
  - Cree XLamp XT LED Family order codes specify only a minimum flux bin and not a maximum. Cree may ship reels in flux bins higher than the minimum specified by the order code without advance notice. Shipments will always adhere to the chromaticity or DWL bin restrictions specified by the order code

**STANDARD ORDER CODES AND BINS (48-VOLT XT-E HVW NEUTRAL WHITE,  $T_j = 85\text{ }^\circ\text{C}$ )**

XLamp XT-E LED Standard Kit Codes - White					
Chromaticity		Minimum Luminous Flux (lm) @ 22 mA*		Order Codes	
Kit	CCT	Code	Flux (lm)	75 CRI Typical	80 CRI Minimum
ANSI Neutral White (3700 K – 5000 K)					
E3	5000 K	R3	122	XTEHVW-Q0-0000-00000LFE3	
		R2	114	XTEHVW-Q0-0000-00000LEE3	
		Q5	107	XTEHVW-Q0-0000-00000LDE3	
		Q4	100	XTEHVW-Q0-0000-00000LCE3	
		Q3	93.9	XTEHVW-Q0-0000-00000LBE3	
F4	4750 K	R4	130	XTEHVW-Q0-0000-00000LGF4	
		R3	122	XTEHVW-Q0-0000-00000LFF4	
		R2	114	XTEHVW-Q0-0000-00000LEF4	
		Q5	107	XTEHVW-Q0-0000-00000LDF4	
		Q4	100	XTEHVW-Q0-0000-00000LCF4	
E4	4500 K	Q3	93.9	XTEHVW-Q0-0000-00000LBF4	
		R4	130	XTEHVW-Q0-0000-00000LGE4	
		R3	122	XTEHVW-Q0-0000-00000LFE4	
		R2	114	XTEHVW-Q0-0000-00000LEE4	
		Q5	107	XTEHVW-Q0-0000-00000LDE4	
F5	4250 K	Q4	100	XTEHVW-Q0-0000-00000LCE4	
		Q3	93.9	XTEHVW-Q0-0000-00000LBE4	
		R2	114	XTEHVW-Q0-0000-00000LEF5	
		Q5	107	XTEHVW-Q0-0000-00000LDF5	XTEHVW-Q0-0000-00000HDF5
		Q4	100	XTEHVW-Q0-0000-00000LCF5	XTEHVW-Q0-0000-00000HCF5
		Q3	93.9	XTEHVW-Q0-0000-00000LBF5	XTEHVW-Q0-0000-00000HBF5
E5	4000 K	Q2	87.4	XTEHVW-Q0-0000-00000LAF5	XTEHVW-Q0-0000-00000HAF5
		P4	80.6	XTEHVW-Q0-0000-00000L9F5	XTEHVW-Q0-0000-00000H9F5
		R2	114	XTEHVW-Q0-0000-00000LEE5	
		Q5	107	XTEHVW-Q0-0000-00000LDE5	XTEHVW-Q0-0000-00000HDE5
		Q4	100	XTEHVW-Q0-0000-00000LCE5	XTEHVW-Q0-0000-00000HCE5
		Q3	93.9	XTEHVW-Q0-0000-00000LBE5	XTEHVW-Q0-0000-00000HBE5
		Q2	87.4	XTEHVW-Q0-0000-00000LAE5	XTEHVW-Q0-0000-00000HAE5
		P4	80.6	XTEHVW-Q0-0000-00000L9E5	XTEHVW-Q0-0000-00000H9E5

- Notes:
- Cree maintains a tolerance of  $\pm 7\%$  on flux and power measurements,  $\pm 0.005$  on chromaticity (CCx, CCy) measurements and  $\pm 2$  on CRI measurements.
  - Cree XLamp XT LED Family order codes specify only a minimum flux bin and not a maximum. Cree may ship reels in flux bins higher than the minimum specified by the order code without advance notice. Shipments will always adhere to the chromaticity or DWL bin restrictions specified by the order code



**STANDARD ORDER CODES AND BINS (48-VOLT XT-E HVW WARM WHITE, T<sub>j</sub> = 85 °C)**

XLamp XT-E HVW LED Standard Kit Codes - White					
Chromaticity		Minimum Luminous Flux (lm) @ 22 mA*		Order Codes	
Kit	CCT	Code	Flux (lm)	82 CRI Typical	80 CRI Minimum
ANSI Warm White (2200 K - 3750 K)					
F6	3750 K	R2	114	XTEHVW-Q0-0000-00000LEF6	
		Q5	107	XTEHVW-Q0-0000-00000LDF6	XTEHVW-Q0-0000-00000HDF6
		Q4	100	XTEHVW-Q0-0000-00000LCF6	XTEHVW-Q0-0000-00000HCF6
		Q3	93.9	XTEHVW-Q0-0000-00000LBF6	XTEHVW-Q0-0000-00000HBF6
		Q2	87.4	XTEHVW-Q0-0000-00000LAF6	XTEHVW-Q0-0000-00000HAF6
		P4	80.6	XTEHVW-Q0-0000-00000L9F6	XTEHVW-Q0-0000-00000H9F6
		P3	73.9	XTEHVW-Q0-0000-00000L8F6	XTEHVW-Q0-0000-00000H8F6
E6	3500 K	R2	114	XTEHVW-Q0-0000-00000LEE6	
		Q5	107	XTEHVW-Q0-0000-00000LDE6	XTEHVW-Q0-0000-00000HDE6
		Q4	100	XTEHVW-Q0-0000-00000LCE6	XTEHVW-Q0-0000-00000HCE6
		Q3	93.9	XTEHVW-Q0-0000-00000LBE6	XTEHVW-Q0-0000-00000HBE6
		Q2	87.4	XTEHVW-Q0-0000-00000LAE6	XTEHVW-Q0-0000-00000HAE6
		P4	80.6	XTEHVW-Q0-0000-00000L9E6	XTEHVW-Q0-0000-00000H9E6
		P3	73.9	XTEHVW-Q0-0000-00000L8E6	XTEHVW-Q0-0000-00000H8E6
F7	3250 K	Q5	107	XTEHVW-Q0-0000-00000LDF7	XTEHVW-Q0-0000-00000HDF7
		Q4	100	XTEHVW-Q0-0000-00000LCF7	XTEHVW-Q0-0000-00000HCF7
		Q3	93.9	XTEHVW-Q0-0000-00000LBF7	XTEHVW-Q0-0000-00000HBF7
		Q2	87.4	XTEHVW-Q0-0000-00000LAF7	XTEHVW-Q0-0000-00000HAF7
		P4	80.6	XTEHVW-Q0-0000-00000L9F7	XTEHVW-Q0-0000-00000H9F7
		P3	73.9	XTEHVW-Q0-0000-00000L8F7	XTEHVW-Q0-0000-00000H8F7
E7	3000 K	Q5	107	XTEHVW-Q0-0000-00000LDE7	XTEHVW-Q0-0000-00000HDE7
		Q4	100	XTEHVW-Q0-0000-00000LCE7	XTEHVW-Q0-0000-00000HCE7
		Q3	93.9	XTEHVW-Q0-0000-00000LBE7	XTEHVW-Q0-0000-00000HBE7
		Q2	87.4	XTEHVW-Q0-0000-00000LAE7	XTEHVW-Q0-0000-00000HAE7
		P4	80.6	XTEHVW-Q0-0000-00000L9E7	XTEHVW-Q0-0000-00000H9E7
		P3	73.9	XTEHVW-Q0-0000-00000L8E7	XTEHVW-Q0-0000-00000H8E7
F8	2850 K	Q4	100	XTEHVW-Q0-0000-00000LCF8	XTEHVW-Q0-0000-00000HCF8
		Q3	93.9	XTEHVW-Q0-0000-00000LBF8	XTEHVW-Q0-0000-00000HBF8
		Q2	87.4	XTEHVW-Q0-0000-00000LAF8	XTEHVW-Q0-0000-00000HAF8
		P4	80.6	XTEHVW-Q0-0000-00000L9F8	XTEHVW-Q0-0000-00000H9F8
		P3	73.9	XTEHVW-Q0-0000-00000L8F8	XTEHVW-Q0-0000-00000H8F8
		P2	67.2	XTEHVW-Q0-0000-00000L7F8	XTEHVW-Q0-0000-00000H7F8
E8	2700 K	Q4	100	XTEHVW-Q0-0000-00000LCE8	XTEHVW-Q0-0000-00000HCE8
		Q3	93.9	XTEHVW-Q0-0000-00000LBE8	XTEHVW-Q0-0000-00000HBE8
		Q2	87.4	XTEHVW-Q0-0000-00000LAE8	XTEHVW-Q0-0000-00000HAE8
		P4	80.6	XTEHVW-Q0-0000-00000L9E8	XTEHVW-Q0-0000-00000H9E8
		P3	73.9	XTEHVW-Q0-0000-00000L8E8	XTEHVW-Q0-0000-00000H8E8
		P2	67.2	XTEHVW-Q0-0000-00000L7E8	XTEHVW-Q0-0000-00000H7E8

- Notes:
- Cree maintains a tolerance of ±7% on flux and power measurements, ±0.005 on chromaticity (CCx, CCy) measurements and ±2 on CRI measurements.
  - Cree XLamp XT LED Family order codes specify only a minimum flux bin and not a maximum. Cree may ship reels in flux bins higher than the minimum specified by the order code without advance notice. Shipments will always adhere to the chromaticity or DWL bin restrictions specified by the order code

**STANDARD ORDER CODES AND BINS (48-VOLT XT-E HVW WARM WHITE, T<sub>j</sub> = 85 °C) - CONTINUED**

XLamp XT-E HVW LED Standard Kit Codes - White					
Chromaticity		Minimum Luminous Flux (lm) @ 22 mA*		Order Codes	
Kit	CCT	Code	Flux (lm)	82 CRI Typical	80 CRI Minimum
ANSI Warm White (2200 K - 3750 K)					
F9	2700 K	Q3	93.9	XTEHVW-Q0-0000-00000LBF9	
		Q2	87.4	XTEHVW-Q0-0000-00000LAF9	XTEHVW-Q0-0000-00000HAF9
		P4	80.6	XTEHVW-Q0-0000-00000L9F9	XTEHVW-Q0-0000-00000H9F9
		P3	73.9		XTEHVW-Q0-0000-00000H8F9
FA	2450 K	P3	73.9		XTEHVW-Q0-0000-00000H8FA
		P2	67.2		XTEHVW-Q0-0000-00000H7FA
		N4	62		XTEHVW-Q0-0000-00000H6FA
EA	2200 K	P2	67.2		XTEHVW-Q0-0000-00000H7EA
		N4	62		XTEHVW-Q0-0000-00000H6EA
		N3	56.8		XTEHVW-Q0-0000-00000H5EA

- Notes:
- Cree maintains a tolerance of ±7% on flux and power measurements, ±0.005 on chromaticity (CCx, CCy) measurements and ±2 on CRI measurements.
  - Cree XLamp XT LED Family order codes specify only a minimum flux bin and not a maximum. Cree may ship reels in flux bins higher than the minimum specified by the order code without advance notice. Shipments will always adhere to the chromaticity or DWL bin restrictions specified by the order code

**STANDARD ORDER CODES AND BINS (XT-E ROYAL BLUE, T<sub>j</sub> = 85 °C)**

The following tables provide order codes for XLamp XT-E Royal Blue LEDs.

XLamp XT-E Royal Blue LEDs							
DWL Kit Codes	Dominant Wavelength Range				Order Codes, Minimum Radiant Flux @ 350 mA, T <sub>j</sub> =85 °C*		
	Min.		Max.		475 mW - Radiant Flux Group Code 31(K)	500 mW - Radiant Flux Group Code 32(L)	525 mW - Radiant Flux Group Code 33(M)
	Group	DWL (nm)	Group	DWL (nm)			
01	D36	450	D57	465	XTEARY-00-0000-000000K01	XTEARY-00-0000-000000L01	XTEARY-00-0000-000000M01
02	D36	450	D47	460	XTEARY-00-0000-000000K02	XTEARY-00-0000-000000L02	XTEARY-00-0000-000000M02
03	D46	455	D57	465	XTEARY-00-0000-000000K03	XTEARY-00-0000-000000L03	XTEARY-00-0000-000000M03
04	D36	450	D37	455	XTEARY-00-0000-000000K04	XTEARY-00-0000-000000L04	XTEARY-00-0000-000000M04
05	D46	455	D47	460	XTEARY-00-0000-000000K05	XTEARY-00-0000-000000L05	XTEARY-00-0000-000000M05
06	D56	460	D57	465	XTEARY-00-0000-000000K06	XTEARY-00-0000-000000L06	XTEARY-00-0000-000000M06
07	D37	452.5	D46	457.5	XTEARY-00-0000-000000K07	XTEARY-00-0000-000000L07	XTEARY-00-0000-000000M07
08	D47	457.5	D56	462.5	XTEARY-00-0000-000000K08	XTEARY-00-0000-000000L08	XTEARY-00-0000-000000M08
09	D37	452.5	D56	462.5	XTEARY-00-0000-000000K09	XTEARY-00-0000-000000L09	XTEARY-00-0000-000000M09

XLamp XT-E Royal Blue LEDs							
DWL Kit Codes	Dominant Wavelength Range				Order Codes, Minimum Radiant Flux @ 350 mA, T <sub>j</sub> =85 °C*		
	Min.		Max.		550 mW - Radiant Flux Group Code 34(N)	575 mW - Radiant Flux Group Code 35(P)	600 mW - Radiant Flux Group Code 36(Q)
	Group	DWL (nm)	Group	DWL (nm)			
01	D36	450	D57	465	XTEARY-00-0000-000000N01	XTEARY-00-0000-000000P01	XTEARY-00-0000-000000Q01
02	D36	450	D47	460	XTEARY-00-0000-000000N02	XTEARY-00-0000-000000P02	XTEARY-00-0000-000000Q02
03	D46	455	D57	465	XTEARY-00-0000-000000N03	XTEARY-00-0000-000000P03	
04	D36	450	D37	455	XTEARY-00-0000-000000N04	XTEARY-00-0000-000000P04	XTEARY-00-0000-000000Q04
05	D46	455	D47	460	XTEARY-00-0000-000000N05	XTEARY-00-0000-000000P05	
06	D56	460	D57	465	XTEARY-00-0000-000000N06		
07	D37	452.5	D46	457.5	XTEARY-00-0000-000000N07	XTEARY-00-0000-000000P07	
08	D47	457.5	D56	462.5	XTEARY-00-0000-000000N08		
09	D37	452.5	D56	462.5	XTEARY-00-0000-000000N09	XTEARY-00-0000-000000P09	

- Notes:
- Cree maintains a tolerance of ±7% on flux and power measurements, ±0.005 on chromaticity (CCx, CCy) measurements and ±2 on CRI measurements.
  - Cree XLamp XT LED Family order codes specify only a minimum flux bin and not a maximum. Cree may ship reels in flux bins higher than the minimum specified by the order code without advance notice. Shipments will always adhere to the chromaticity or DWL bin restrictions specified by the order code