

Speed Control and Needle Valves

Specification



Construction:
Brass 58 – UNI 5705 (G $\frac{1}{4}$ model-steel)
Nickel plated.

Max. working pressure:
210 bar.

Operating temp. range:
-20°C to +100°C.

Fluid compatibility:
Petroleum-based oils.

Sizes:
G $\frac{1}{4}$, G $\frac{3}{8}$, G $\frac{1}{2}$ and G $\frac{3}{4}$.

Speed control valve/check valve
crack pressure:
0.5 bar.

Panel mounting:
A retaining nut for panel mounting is included with every option.

Filtration recommendation:
Parker Filtration 25 micron absolute system filtration is desirable to ensure acceptable reliability and service life.

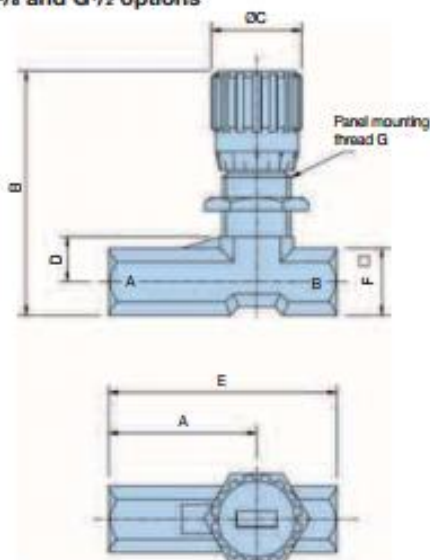
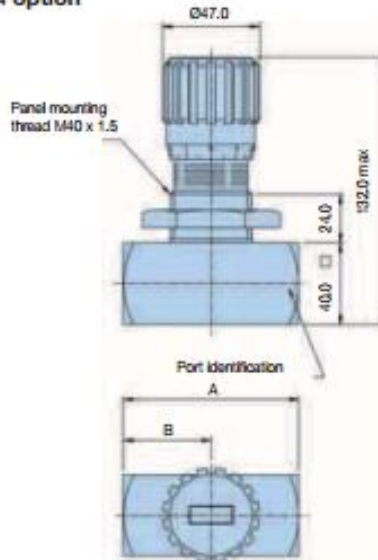
G $\frac{1}{4}$, G $\frac{3}{8}$ and G $\frac{1}{2}$ optionsG $\frac{3}{4}$ option

Ordering Information

Speed Control Valves – white caps

Part number	Description	A mm	B mm	C mm	D mm	E mm	F Size	G Panel mtg thread	Weight Kg
SCV1700	G $\frac{1}{4}$, 210 bar speed control	36	60	22	11	66.5	16.5	M17 x 1	0.13
SCV1701	G $\frac{3}{8}$, 210 bar speed control	41.5	72.5	27	15	64.5	21.5	M20 x 1	0.24
SCV1702	G $\frac{1}{2}$, 210 bar speed control	57	85	33	19	67	27	M25 x 1.5	0.46
SCV1703	G $\frac{3}{4}$, 210 bar speed control	85	125	-	-	-	-	M40 x 1.5	1.3

Needle Valves – orange caps

Part number	Description	A mm	B mm	C mm	D mm	E mm	F Size	G Panel mtg thread	Weight Kg
2000	G $\frac{1}{4}$, 210 bar needle valve	36	60	22	11	66.5	16.5	M17 x 1	0.13
2001	G $\frac{3}{8}$, 210 bar needle valve	41.5	72.5	27	15	64.5	21.5	M20 x 1	0.24
2002	G $\frac{1}{2}$, 210 bar needle valve	57	85	33	19	67	27	M25 x 1.5	0.46
2003	G $\frac{3}{4}$, 210 bar needle valve	115	73	-	-	-	-	M40 x 1.5	1.6

Pressure drop (ΔP) flow characteristics with mineral oil at 30 cSt viscosity

Graphs for needle/shut-off valves and speed control valves with flow A-B (controlled flow through needle).

Flow setting by number of turns of control knob is indicated on the body graduated scale.

Graphs for speed control valves. Flow B-A (flow through check valve), with needle valve portion in fully open and fully closed positions.

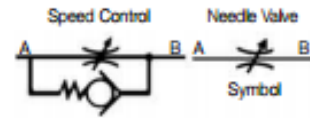

2000/SCV1700 – Flow setting in no. of turns

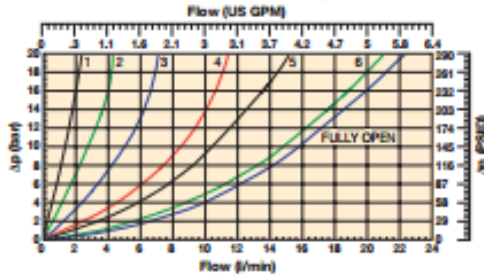

2002/SCV1702 – Flow setting in no. of turns

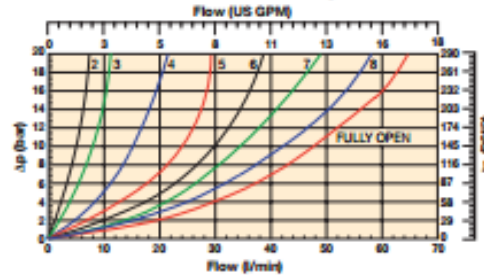

SCV1700 – Flow setting (fully closed/fully open)

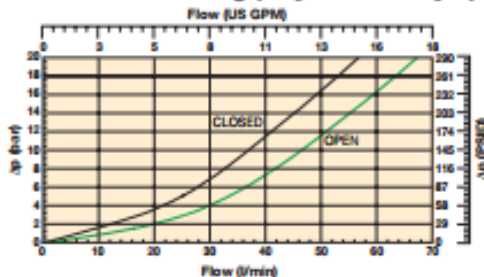

SCV1702 – Flow setting (fully closed/fully open)

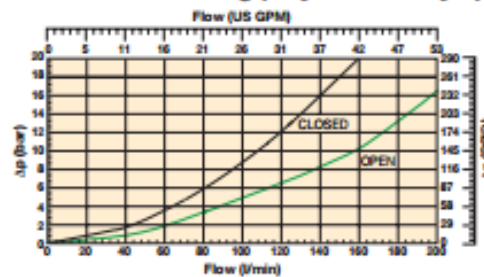

2001/SCV1701 – Flow setting in no. of turns

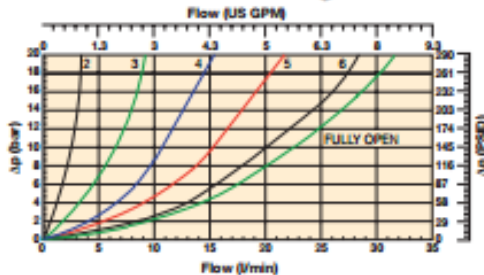

2003/SCV1703 – Flow setting in no. of turns

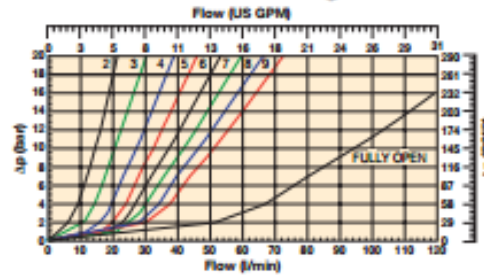

SCV1701 – Flow setting (fully closed/fully open)

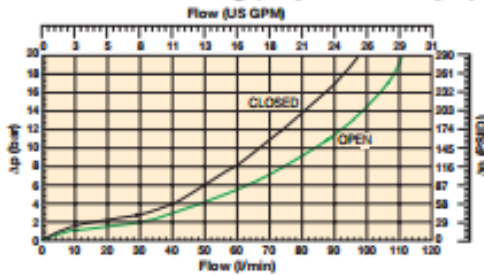

SCV1703 – Flow setting (fully closed/fully open)

