

REVISIONS

P	LTR	DESCRIPTION	DATE	DWN	APVD
	BA	INITIAL DRAWING RELEASE	04SEP2024	AR	GT

FOR FURTHER DETAILS PLEASE REFER TO THICK FILM PRECISION RESISTOR TYPE RT73 SERIES

RECOMMENDED LAND PATTERN

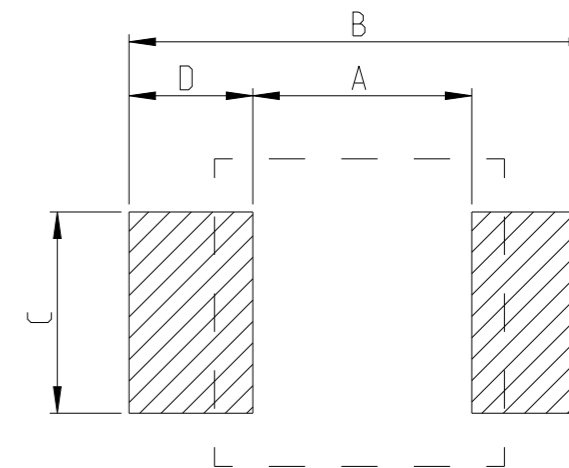

TYPE	SIZE (INCH)	A (mm)	B (mm)	C (mm)	D (mm)
RT73 2A	0805	1.3	2.5	1.05	0.6

RoHS Compliant

TYPE (INCH SIZE CODE)	L (mm)	W (mm)	c (mm)	d (mm)	t (mm)
2A (0805)	2.0±0.2	1.25±0.1	0.25±0.15	0.3 <sup>+0.2</sup> <sub>-0.1</sub>	0.5±0.1

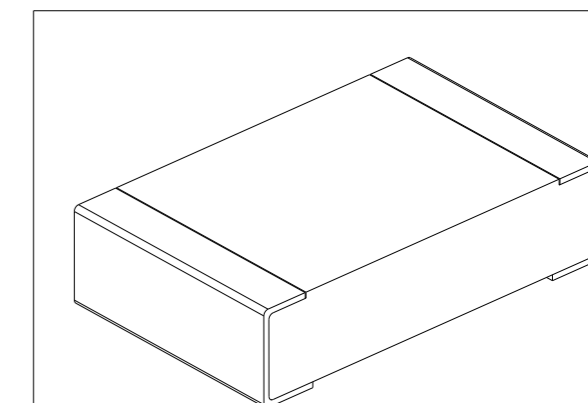

THIS DRAWING IS A CONTROLLED DOCUMENT.

DIMENSIONS:	TOLERANCES UNLESS OTHERWISE SPECIFIED:
mm	
	0 PLC ±
	1 PLC ±
	2 PLC ±
	3 PLC ±
	4 PLC ±
	ANGLES ±
MATERIAL	FINISH
-	-
-	-

DWN	ASHOK RAJ	04SEP2024
CHK	TRACY G	04SEP2024
APVD	TRACY G	04SEP2024
PRODUCT SPEC	-	
APPLICATION SPEC	-	
WEIGHT	-	
CUSTOMER DRAWING		



THICK FILM PRECISION RESISTOR TYPE RT73 2A SERIES

SIZE	CAGE CODE	DRAWING NO	RESTRICTED TO
A3	00779	©=2176763	-
SCALE 50:1		SHEET 1 OF 5	REV BA

REVISIONS

P	LTR	DESCRIPTION	DATE	DWN	APVD
-		SEE SHEET 1	-	-	-

SCHEDULE

TCPN	CATALOGUE NUMBER	PART DESCRIPTION	PART STATUS
2176763-1	RT73F2A107RBT	RT 2A 0.25W 107R 0.1% 25PPM 5K RL	PRODUCTION
2176763-2	RT73F2A110RBT	RT 2A 0.25W 110R 0.1% 25PPM 5K RL	PRODUCTION
2176763-3	RT73F2A113RBT	RT 2A 0.25W 113R 0.1% 25PPM 5K RL	PRODUCTION
2176763-4	RT73F2A115RBT	RT 2A 0.25W 115R 0.1% 25PPM 5K RL	PRODUCTION
2176763-5	RT73F2A118RBT	RT 2A 0.25W 118R 0.1% 25PPM 5K RL	PRODUCTION
2176763-6	RT73F2A121RBT	RT 2A 0.25W 121R 0.1% 25PPM 5K RL	PRODUCTION
2176763-7	RT73F2A124RBT	RT 2A 0.25W 124R 0.1% 25PPM 5K RL	PRODUCTION
2176763-8	RT73F2A127RBT	RT 2A 0.25W 127R 0.1% 25PPM 5K RL	PRODUCTION
2176763-9	RT73F2A130RBT	RT 2A 0.25W 130R 0.1% 25PPM 5K RL	PRODUCTION
1-2176763-0	RT73F2A133RBT	RT 2A 0.25W 133R 0.1% 25PPM 5K RL	PRODUCTION
1-2176763-1	RT73F2A137RBT	RT 2A 0.25W 137R 0.1% 25PPM 5K RL	PRODUCTION
1-2176763-2	RT73F2A140RBT	RT 2A 0.25W 140R 0.1% 25PPM 5K RL	PRODUCTION
1-2176763-3	RT73F2A143RBT	RT 2A 0.25W 143R 0.1% 25PPM 5K RL	PRODUCTION
1-2176763-4	RT73F2A147RBT	RT 2A 0.25W 147R 0.1% 25PPM 5K RL	PRODUCTION
1-2176763-5	RT73F2A150RBT	RT 2A 0.25W 150R 0.1% 25PPM 5K RL	PRODUCTION
1-2176763-6	RT73F2A154RBT	RT 2A 0.25W 154R 0.1% 25PPM 5K RL	PRODUCTION
1-2176763-7	RT73F2A158RBT	RT 2A 0.25W 158R 0.1% 25PPM 5K RL	PRODUCTION
1-2176763-8	RT73F2A162RBT	RT 2A 0.25W 162R 0.1% 25PPM 5K RL	PRODUCTION
1-2176763-9	RT73F2A165RBT	RT 2A 0.25W 165R 0.1% 25PPM 5K RL	PRODUCTION
2-2176763-0	RT73F2A169RBT	RT 2A 0.25W 169R 0.1% 25PPM 5K RL	PRODUCTION
2-2176763-1	RT73F2A174RBT	RT 2A 0.25W 174R 0.1% 25PPM 5K RL	PRODUCTION
2-2176763-2	RT73F2A178RBT	RT 2A 0.25W 178R 0.1% 25PPM 5K RL	PRODUCTION
2-2176763-3	RT73F2A182RBT	RT 2A 0.25W 182R 0.1% 25PPM 5K RL	PRODUCTION
2-2176763-4	RT73F2A187RBT	RT 2A 0.25W 187R 0.1% 25PPM 5K RL	PRODUCTION
2-2176763-5	RT73F2A191RBT	RT 2A 0.25W 191R 0.1% 25PPM 5K RL	PRODUCTION

THIS DRAWING IS A CONTROLLED DOCUMENT.

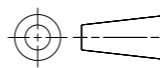
DIMENSIONS: mm	TOLERANCES UNLESS OTHERWISE SPECIFIED:
	0 PLC ± 1 PLC ± 2 PLC ± 3 PLC ± 4 PLC ± ANGLES ±
MATERIAL -	FINISH -

DWN ASHOK RAJ	04SEP2024
CHK TRACY G	04SEP2024
APVD TRACY G	04SEP2024
PRODUCT SPEC	-
APPLICATION SPEC	-
WEIGHT	-
CUSTOMER DRAWING	



THICK FILM PRECISION RESISTOR  
TYPE RT73 2A SERIES

SIZE A3	CAGE CODE 00779	DRAWING NO C=2176763	RESTRICTED TO -
SCALE 1:1		SHEET 2 OF 5	REV BA

REVISIONS

P	LTR	DESCRIPTION	DATE	DWN	APVD
-		SEE SHEET 1	-	-	-

SCHEDULE

TCPN	CATALOGUE NUMBER	PART DESCRIPTION	PART STATUS
2-2176763-6	RT73F2A196RBT	RT 2A 0.25W 196R 0.1% 25PPM 5K RL	PRODUCTION
2-2176763-7	RT73F2A200RBT	RT 2A 0.25W 200R 0.1% 25PPM 5K RL	PRODUCTION
2-2176763-8	RT73F2A205RBT	RT 2A 0.25W 205R 0.1% 25PPM 5K RL	PRODUCTION
2-2176763-9	RT73F2A210RBT	RT 2A 0.25W 210R 0.1% 25PPM 5K RL	PRODUCTION
3-2176763-0	RT73F2A215RBT	RT 2A 0.25W 215R 0.1% 25PPM 5K RL	PRODUCTION
3-2176763-1	RT73F2A221RBT	RT 2A 0.25W 221R 0.1% 25PPM 5K RL	PRODUCTION
3-2176763-2	RT73F2A226RBT	RT 2A 0.25W 226R 0.1% 25PPM 5K RL	PRODUCTION
3-2176763-3	RT73F2A232RBT	RT 2A 0.25W 232R 0.1% 25PPM 5K RL	PRODUCTION
3-2176763-4	RT73F2A237RBT	RT 2A 0.25W 237R 0.1% 25PPM 5K RL	PRODUCTION
3-2176763-5	RT73F2A243RBT	RT 2A 0.25W 243R 0.1% 25PPM 5K RL	PRODUCTION
3-2176763-6	RT73F2A249RBT	RT 2A 0.25W 249R 0.1% 25PPM 5K RL	PRODUCTION
3-2176763-7	RT73F2A255RBT	RT 2A 0.25W 255R 0.1% 25PPM 5K RL	PRODUCTION
3-2176763-8	RT73F2A261RBT	RT 2A 0.25W 261R 0.1% 25PPM 5K RL	PRODUCTION
3-2176763-9	RT73F2A267RBT	RT 2A 0.25W 267R 0.1% 25PPM 5K RL	PRODUCTION
4-2176763-0	RT73F2A274RBT	RT 2A 0.25W 274R 0.1% 25PPM 5K RL	PRODUCTION
4-2176763-1	RT73F2A280RBT	RT 2A 0.25W 280R 0.1% 25PPM 5K RL	PRODUCTION
4-2176763-2	RT73F2A287RBT	RT 2A 0.25W 287R 0.1% 25PPM 5K RL	PRODUCTION
4-2176763-3	RT73F2A294RBT	RT 2A 0.25W 294R 0.1% 25PPM 5K RL	PRODUCTION
4-2176763-4	RT73F2A301RBT	RT 2A 0.25W 301R 0.1% 25PPM 5K RL	PRODUCTION
4-2176763-5	RT73F2A309RBT	RT 2A 0.25W 309R 0.1% 25PPM 5K RL	PRODUCTION
4-2176763-6	RT73F2A316RBT	RT 2A 0.25W 316R 0.1% 25PPM 5K RL	PRODUCTION
4-2176763-7	RT73F2A324RBT	RT 2A 0.25W 324R 0.1% 25PPM 5K RL	PRODUCTION
4-2176763-8	RT73F2A332RBT	RT 2A 0.25W 332R 0.1% 25PPM 5K RL	PRODUCTION
4-2176763-9	RT73F2A340RBT	RT 2A 0.25W 340R 0.1% 25PPM 5K RL	PRODUCTION
5-2176763-0	RT73F2A348RBT	RT 2A 0.25W 348R 0.1% 25PPM 5K RL	PRODUCTION

THIS DRAWING IS A CONTROLLED DOCUMENT.

DIMENSIONS:  
mm

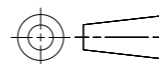

TOLERANCES UNLESS OTHERWISE SPECIFIED:

- 0 PLC ±
- 1 PLC ±
- 2 PLC ±
- 3 PLC ±
- 4 PLC ±
- ANGLES ±
- FINISH -

MATERIAL  
-

DWN 04SEP2024  
ASHOK RAJ

CHK 04SEP2024  
TRACY G

APVD 04SEP2024  
TRACY G

PRODUCT SPEC

-

APPLICATION SPEC

-

WEIGHT -

CUSTOMER DRAWING



TE Connectivity

NAME THICK FILM PRECISION RESISTOR  
TYPE RT73 2A SERIES

SIZE CAGE CODE DRAWING NO RESTRICTED TO

A3 00779 C-2176763

SCALE 1:1 SHEET 3 OF 5 REV BA

REVISIONS

P	LTR	DESCRIPTION	DATE	DWN	APVD
-		SEE SHEET 1	-	-	-

SCHEDULE

TCPN	CATALOGUE NUMBER	PART DESCRIPTION	PART STATUS
5-2176763-1	RT73F2A357RBTD	RT 2A 0.25W 357R 0.1% 25PPM 5K RL	PRODUCTION
5-2176763-2	RT73F2A365RBTD	RT 2A 0.25W 365R 0.1% 25PPM 5K RL	PRODUCTION
5-2176763-3	RT73F2A374RBTD	RT 2A 0.25W 374R 0.1% 25PPM 5K RL	PRODUCTION
5-2176763-4	RT73F2A383RBTD	RT 2A 0.25W 383R 0.1% 25PPM 5K RL	PRODUCTION
5-2176763-5	RT73F2A392RBTD	RT 2A 0.25W 392R 0.1% 25PPM 5K RL	PRODUCTION
5-2176763-6	RT73F2A402RBTD	RT 2A 0.25W 402R 0.1% 25PPM 5K RL	PRODUCTION
5-2176763-7	RT73F2A412RBTD	RT 2A 0.25W 412R 0.1% 25PPM 5K RL	PRODUCTION
5-2176763-8	RT73F2A422RBTD	RT 2A 0.25W 422R 0.1% 25PPM 5K RL	PRODUCTION
5-2176763-9	RT73F2A432RBTD	RT 2A 0.25W 432R 0.1% 25PPM 5K RL	PRODUCTION
6-2176763-0	RT73F2A442RBTD	RT 2A 0.25W 442R 0.1% 25PPM 5K RL	PRODUCTION
6-2176763-1	RT73F2A453RBTD	RT 2A 0.25W 453R 0.1% 25PPM 5K RL	PRODUCTION
6-2176763-2	RT73F2A464RBTD	RT 2A 0.25W 464R 0.1% 25PPM 5K RL	PRODUCTION
6-2176763-3	RT73F2A475RBTD	RT 2A 0.25W 475R 0.1% 25PPM 5K RL	PRODUCTION
6-2176763-4	RT73F2A487RBTD	RT 2A 0.25W 487R 0.1% 25PPM 5K RL	PRODUCTION
6-2176763-5	RT73F2A499RBTD	RT 2A 0.25W 499R 0.1% 25PPM 5K RL	PRODUCTION
6-2176763-6	RT73F2A511RBTD	RT 2A 0.25W 511R 0.1% 25PPM 5K RL	PRODUCTION
6-2176763-7	RT73F2A523RBTD	RT 2A 0.25W 523R 0.1% 25PPM 5K RL	PRODUCTION
6-2176763-8	RT73F2A536RBTD	RT 2A 0.25W 536R 0.1% 25PPM 5K RL	PRODUCTION
6-2176763-9	RT73F2A549RBTD	RT 2A 0.25W 549R 0.1% 25PPM 5K RL	PRODUCTION
7-2176763-0	RT73F2A562RBTD	RT 2A 0.25W 562R 0.1% 25PPM 5K RL	PRODUCTION
7-2176763-1	RT73F2A576RBTD	RT 2A 0.25W 576R 0.1% 25PPM 5K RL	PRODUCTION
7-2176763-2	RT73F2A590RBTD	RT 2A 0.25W 590R 0.1% 25PPM 5K RL	PRODUCTION
7-2176763-3	RT73F2A604RBTD	RT 2A 0.25W 604R 0.1% 25PPM 5K RL	PRODUCTION
7-2176763-4	RT73F2A619RBTD	RT 2A 0.25W 619R 0.1% 25PPM 5K RL	PRODUCTION
7-2176763-5	RT73F2A634RBTD	RT 2A 0.25W 634R 0.1% 25PPM 5K RL	PRODUCTION

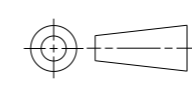
THIS DRAWING IS A CONTROLLED DOCUMENT.		DWN ASHOK RAJ	04SEP2024	 TE Connectivity	
DIMENSIONS: mm		CHK TRACY G	04SEP2024		
		APVD TRACY G	04SEP2024		
TOLERANCES UNLESS OTHERWISE SPECIFIED:		PRODUCT SPEC	-		
MATERIAL		APPLICATION SPEC	-	NAME THICK FILM PRECISION RESISTOR TYPE RT73 2A SERIES	
-		WEIGHT	-	SIZE	A3
-		CUSTOMER DRAWING	-	CAGE CODE	00779
		SCALE	1:1	DRAWING NO	C=2176763
		SHEET	4 OF 5	RESTRICTED TO	-
		REV	BA		

REVISIONS

P	LTR	DESCRIPTION	DATE	DWN	APVD
-		SEE SHEET 1	-	-	-

SCHEDULE

TCPN	CATALOGUE NUMBER	PART DESCRIPTION	PART STATUS
7-2176763-6	RT73F2A649RBT	RT 2A 0.25W 649R 0.1% 25PPM 5K RL	PRODUCTION
7-2176763-7	RT73F2A665RBT	RT 2A 0.25W 665R 0.1% 25PPM 5K RL	PRODUCTION
7-2176763-8	RT73F2A681RBT	RT 2A 0.25W 681R 0.1% 25PPM 5K RL	PRODUCTION
7-2176763-9	RT73F2A698RBT	RT 2A 0.25W 698R 0.1% 25PPM 5K RL	PRODUCTION
8-2176763-0	RT73F2A715RBT	RT 2A 0.25W 715R 0.1% 25PPM 5K RL	PRODUCTION
8-2176763-1	RT73F2A732RBT	RT 2A 0.25W 732R 0.1% 25PPM 5K RL	PRODUCTION
8-2176763-2	RT73F2A750RBT	RT 2A 0.25W 750R 0.1% 25PPM 5K RL	PRODUCTION
8-2176763-3	RT73F2A768RBT	RT 2A 0.25W 768R 0.1% 25PPM 5K RL	PRODUCTION
8-2176763-4	RT73F2A787RBT	RT 2A 0.25W 787R 0.1% 25PPM 5K RL	PRODUCTION
8-2176763-5	RT73F2A806RBT	RT 2A 0.25W 806R 0.1% 25PPM 5K RL	PRODUCTION
8-2176763-6	RT73F2A825RBT	RT 2A 0.25W 825R 0.1% 25PPM 5K RL	PRODUCTION
8-2176763-7	RT73F2A845RBT	RT 2A 0.25W 845R 0.1% 25PPM 5K RL	PRODUCTION
8-2176763-8	RT73F2A866RBT	RT 2A 0.25W 866R 0.1% 25PPM 5K RL	PRODUCTION
8-2176763-9	RT73F2A887RBT	RT 2A 0.25W 887R 0.1% 25PPM 5K RL	PRODUCTION
9-2176763-0	RT73F2A909RBT	RT 2A 0.25W 909R 0.1% 25PPM 5K RL	PRODUCTION
9-2176763-1	RT73F2A931RBT	RT 2A 0.25W 931R 0.1% 25PPM 5K RL	PRODUCTION
9-2176763-2	RT73F2A953RBT	RT 2A 0.25W 953R 0.1% 25PPM 5K RL	PRODUCTION
9-2176763-3	RT73F2A976RBT	RT 2A 0.25W 976R 0.1% 25PPM 5K RL	PRODUCTION
9-2176763-4	RT73F2A1K0BT	RT 2A 0.25W 1K0 0.1% 25PPM 5K RL	PRODUCTION
9-2176763-5	RT73F2A1K02BT	RT 2A 0.25W 1K02 0.1% 25PPM 5K RL	PRODUCTION
9-2176763-6	RT73F2A1K05BT	RT 2A 0.25W 1K05 0.1% 25PPM 5K RL	PRODUCTION
9-2176763-7	RT73F2A1K07BT	RT 2A 0.25W 1K07 0.1% 25PPM 5K RL	PRODUCTION
9-2176763-8	RT73F2A1K1BT	RT 2A 0.25W 1K1 0.1% 25PPM 5K RL	PRODUCTION
9-2176763-9	RT73F2A1K13BT	RT 2A 0.25W 1K13 0.1% 25PPM 5K RL	PRODUCTION

THIS DRAWING IS A CONTROLLED DOCUMENT.

DIMENSIONS:  
mm

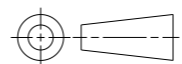

TOLERANCES UNLESS OTHERWISE SPECIFIED:

- 0 PLC ±
- 1 PLC ±
- 2 PLC ±
- 3 PLC ±
- 4 PLC ±
- ANGLES ±
- FINISH -

MATERIAL

-

DWN 04SEP2024

ASHOK RAJ

CHK 04SEP2024

TRACY G

APVD 04SEP2024

TRACY G

PRODUCT SPEC

-

APPLICATION SPEC

-

WEIGHT

-

CUSTOMER DRAWING



TE Connectivity

NAME THICK FILM PRECISION RESISTOR  
TYPE RT73 2A SERIES

SIZE CAGE CODE DRAWING NO RESTRICTED TO

A3 00779 C-2176763

SCALE 1:1 SHEET 5 OF 5 REV BA