

HIGH VOLTAGE ULTRAFAST RECTIFIER
MAIN PRODUCT CHARACTERISTICS

I_{F(AV)}	1 A
V_{RRM}	800 V
T_j (max)	175 °C
V_F (max)	1.25 V

FEATURES AND BENEFITS

- Low forward voltage drop
- High reliability
- High surge current capability
- Soft switching for reduced EMI disturbances
- Planar technology

DESCRIPTION

The STTH108, which is using ST ultrafast high voltage planar technology, is specially suited for free-wheeling, clamping, snubbing, demagnetization in power supplies and other power switching applications.

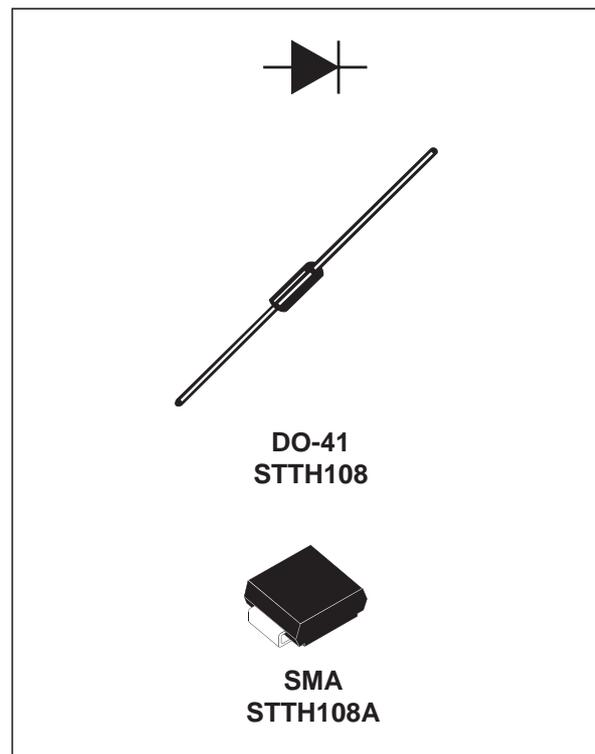
ABSOLUTE RATINGS (limiting values)

Symbol	Parameter			Value	Unit
V _{RRM}	Repetitive peak reverse voltage			800	V
V _(RMS)	RMS voltage			560	V
I _{F(AV)}	Average forward current	TI = 110°C δ = 0.5	DO-41	1	A
		TI = 130°C δ = 0.5	SMA	1	
I _{FSM}	Forward surge current t = 8.3 ms	DO-41		25	A
		SMA		20	
T _{stg}	Storage temperature range			- 50 + 175	°C
T _j	Maximum operating junction temperature			+ 175	°C

THERMAL PARAMETERS

Symbol	Parameter			Value	Unit
$R_{th(j-l)}$	Junction to lead	L = 10 mm	DO-41	45	°C/W
			SMA	30	
$R_{th(j-a)}$	Junction to ambient	L = 10 mm	DO-41	110	

STATIC ELECTRICAL CHARACTERISTICS

Symbol	Parameter	Tests conditions		Min.	Typ.	Max.	Unit
I_R	Reverse leakage current	$V_R = 800V$	$T_j = 25^\circ C$			5	μA
			$T_j = 125^\circ C$			50	
V_F	Forward voltage drop	$I_F = 1 A$	$T_j = 25^\circ C$			1.65	V
			$T_j = 150^\circ C$		0.89	1.25	

To evaluate the maximum conduction losses use the following equation :

$$P = 1.05 \times I_{F(AV)} + 0.20 I_{F(RMS)}^2$$

DYNAMIC ELECTRICAL CHARACTERISTICS

Symbol	Parameter	Tests conditions		Min.	Typ.	Max.	Unit
t_{rr}	Reverse recovery time	$I_F = 0.5 A$ $I_{rr} = 0.25 A$ $I_R = 1A$	$T_j = 25^\circ C$			75	ns
t_{fr}	Forward recovery time	$I_F = 1 A$ $dI_F/dt = 50 A/\mu s$ $V_{FR} = 1.1 \times V_{Fmax}$	$T_j = 25^\circ C$			200	ns
V_{FP}	Forward recovery voltage						12

Fig. 1: Conduction losses versus average current.

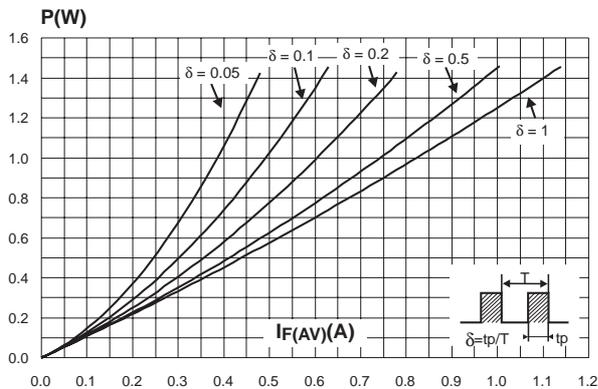

Fig. 2: Forward voltage drop versus forward current.

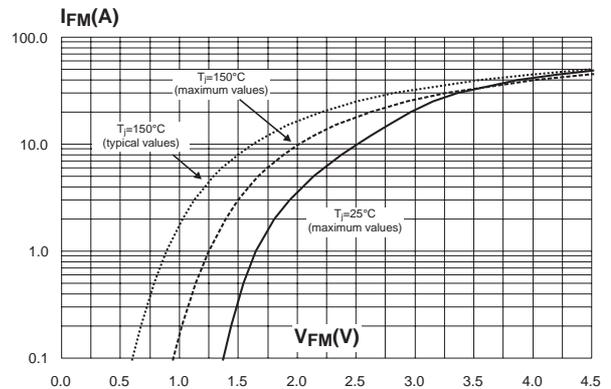

Fig. 3-1: Relative variation of thermal impedance junction ambient versus pulse duration (epoxy FR4, L_{leads} = 10mm) (DO-41).

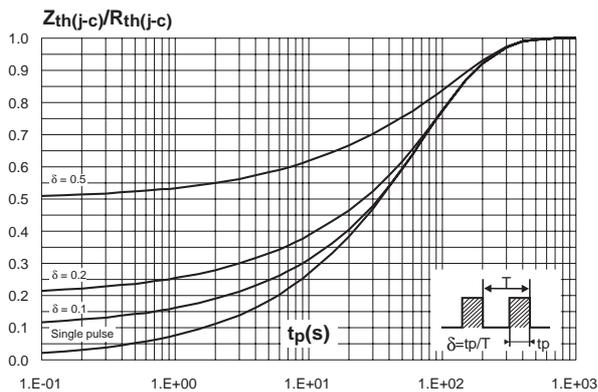

Fig. 3-2: Relative variation of thermal impedance junction ambient versus pulse duration (epoxy FR4) (SMA).

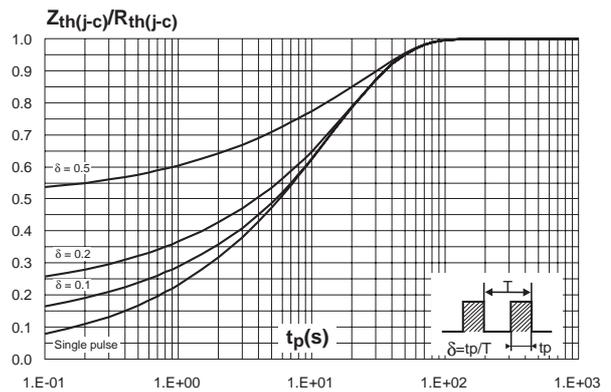

Fig. 4-1: Thermal resistance junction to ambient versus copper surface under each lead (epoxy printed circuit board FR4, copper thickness: 35µm) (DO-41).

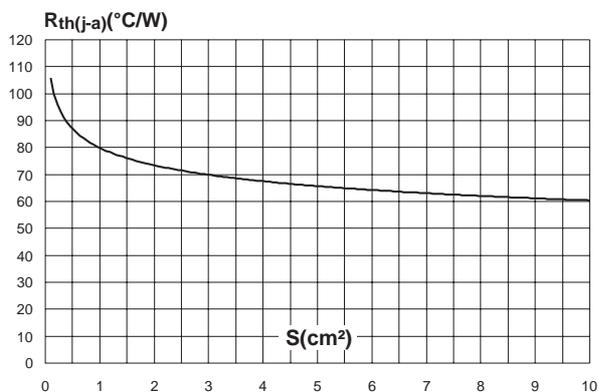
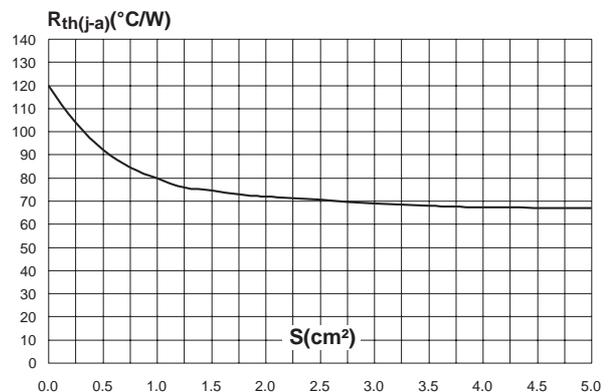
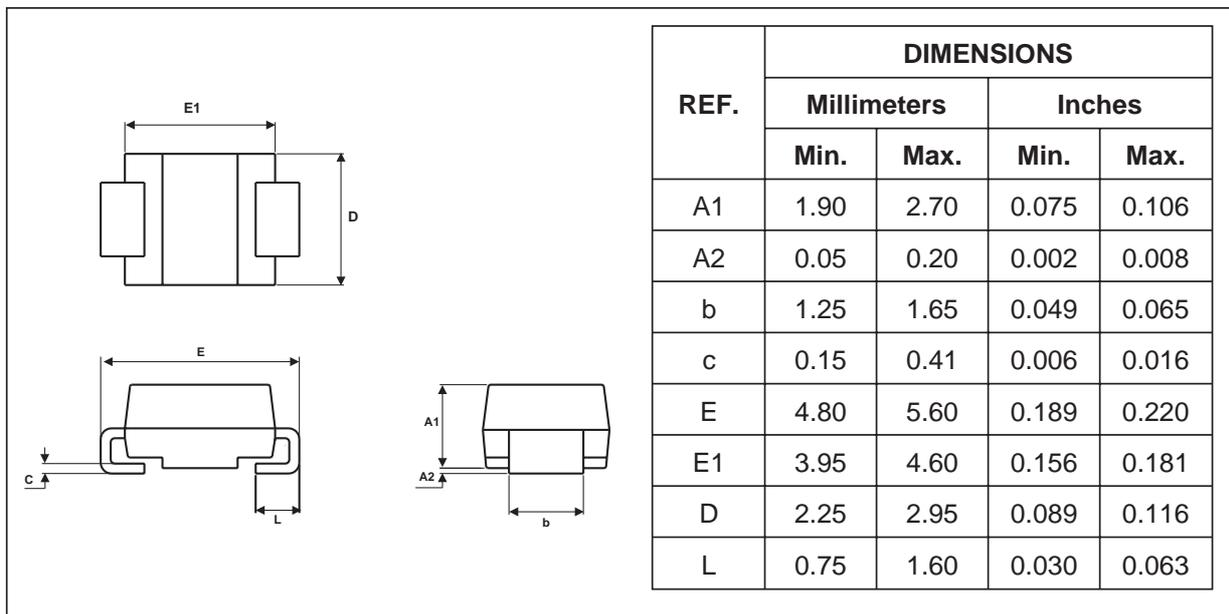

Fig. 4-2: Thermal resistance junction to ambient versus copper surface under each lead (epoxy printed circuit board FR4, copper thickness: 35µm) (SMA).



PACKAGE MECHANICAL DATA
SMA



FOOTPRINT (in millimeters)

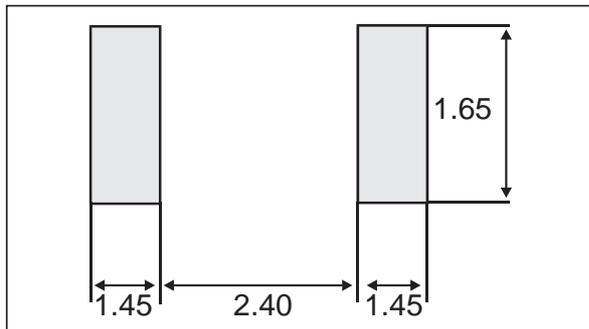

PACKAGE MECHANICAL DATA
DO41

	DIMENSIONS				
	REF.	Millimeters		Inches	
		Min.	Max.	Min.	Max.
	A	4.07	5.20	0.160	0.205
B	2.04	2.71	0.080	0.107	
C	28		1.102		
D	0.712	0.863	0.028	0.034	

Ordering code	Marking	Package	Weight	Base qty	Delivery mode
STTH108	STTH108	DO-41	0.34 g	2000	Ammopack
STTH108A	H08	SMA	0.068 g	5000	Tape & reel
STTH108RL	STTH108	DO-41	0.34 g	5000	Tape & reel

- Epoxy meets UL 94,V0

Information furnished is believed to be accurate and reliable. However, STMicroelectronics assumes no responsibility for the consequences of use of such information nor for any infringement of patents or other rights of third parties which may result from its use. No license is granted by implication or otherwise under any patent or patent rights of STMicroelectronics. Specifications mentioned in this publication are subject to change without notice. This publication supersedes and replaces all information previously supplied. STMicroelectronics products are not authorized for use as critical components in life support devices or systems without express written approval of STMicroelectronics.

The ST logo is a registered trademark of STMicroelectronics

© 2003 STMicroelectronics - Printed in Italy - All rights reserved.

STMicroelectronics GROUP OF COMPANIES

Australia - Brazil - Canada - China - Finland - France - Germany
 Hong Kong - India - Israel - Italy - Japan - Malaysia - Malta - Morocco - Singapore
 Spain - Sweden - Switzerland - United Kingdom - United States.

<http://www.st.com>