



Every part matters

SPECIFICATION FOR APPROVAL

CUSTOMER/客户 : 01097
 ARTICLE/品名: SWITCHING MODE POWER SUPPLY
 SPECIFICATION /规格: GS
 MODEL NO/产品型号.: DYS850-150336W-2
 OUR PART NO./产品编号: DYS850-150336-20104
 CUSTOMER P. N/客户料号:
 INPUT/输入 : 100-240V AC 50/60Hz
 OUTPUT/输出: 15.0V DC 3.36A
 INPUT/输入 : 100-240V AC 50/60Hz
 REV/DATE:/版本/日期: 01 2020/01/06

Vendor Confirmation/供应商确认			Confirmation Approved/客户确认		
Made by	Checked by	Approved by	Made by	Checked by	Approved by
Liuhuixian	Liufei	Wuguoming			
Remark/备注:					

SWITCHING MODE POWER SUPPLY
SPECIFICATION

E.C.LIST/变更履历表

Rev. 版本	Description of Change/变更内容描述		Changed Date/日期	Operator/ 执行者
	Before/变更前	After/变更后		
01	Original Release(初次发行)		2020/01/06	Liuhuixian

SWITCHING MODE POWER SUPPLY SPECIFICATION

CONTENTS/目录

1	Compendium/简述.....	4
2	Input Characteristics/输入特性.....	4
2.1	Input Voltage & Frequency/输入电压&频率.....	4
2.2	Input AC Current/AC 输入电流.....	4
2.3	Inrush Current (Cold Start)/浪涌电流(冷启动).....	4
2.4	Efficiency (Normal)/效率(额定输入)	4
2.5	Energy Consumption /空载功耗.....	4
3	Output Characteristics/输出特性.....	5
3.1	Static Output Characteristics <Vo & R+N>/静态输出特性.....	5
3.2	Line / Load Regulation/线性/负载调整率.....	5
3.3	Turn on Delay Time/开机延迟时间.....	5
3.4	Hold up Time/关机维持时间.....	5
3.5	Capacitance Load/容性负载.....	5
3.6	Output Overshoot / Undershoot/输出过冲/欠冲.....	5
3.7	Output Load Transient Response/输出负载瞬态响应.....	5
4	Protection Requirements/保护特性.....	6
4.1	Over Current Protection/过流保护.....	6
4.2	Short Circuit Protection/短路保护.....	6
4.3	Over Voltage Protection/过压保护.....	6
5	Environment Requirements/环境要求	6
5.1	Operating Temperature and Relative Humidity/操作温/湿度要求.....	6
5.2	Storage Temperature and Relative Humidity/存储温/湿度要求.....	6
5.3	Vibration/振动.....	6
5.4	Drop in /跌落.....	6
6	Reliability Requirements/可靠性要求.....	7
6.1	Burn-in/煲机.....	7
6.2	MTBF Qualification/平均间隔故障时间估算.....	7
7	EMI/EMS Standards/EMI/EMS 标准.....	7
7.1	EMI Standards/EMI 标准.....	7
7.2	EMS Standards/EMS 标准.....	7
8	Safety Standards/安规标准.....	8
8.1	Safety Accord with/安全:符合标准.....	8
8.2	Dielectric Strength(Hi-pot)/介电耐压强度(高压).....	8
8.3	Leakage Current/漏电流.....	8
8.4	Insulation Resistance/绝缘阻抗.....	8
9	Outline Drawing/外观示意图:.....	9
10	DC Cord Drawing/DC 线示意图:.....	10
11	Marking Drawing/铭牌示意图:.....	11
12	Package Drawing/包装示意图:.....	12

SWITCHING MODE POWER SUPPLY SPECIFICATION

1. Compendium/简述

The document details the electrical, mechanical and environmental specifications of a SMPS, the power supply provides **50.4 W** continuous output power.

资料详细描述了一款 **50.4 W**(连续输出功率)开关电源的电气性, 结构性及环境等要求.

The power supply shall meet the **RoHS** requirements.

此款电源符合 **RoHS** 要求.

1.1 Description/描述

- | | |
|---|---|
| <input checked="" type="checkbox"/> SMPS Adapter(Wall mount)/插墙式适配器 | <input type="checkbox"/> SMPS Adapter(Interchangeable)/可换头适配器 |
| <input type="checkbox"/> SMPS Adapter(Desk-top)/桌面型适配器 | <input type="checkbox"/> Open Frame/开放式结构 |
| <input type="checkbox"/> SMPS Unit (With Case)/带铁壳型 | <input type="checkbox"/> Others/其他 |

2. Input Characteristics/输入特性

2.1 Input Voltage & Frequency/输入电压与频率

The range of input voltage is from **90Vac** to **264Vac** with a single phase.

输入电压范围: 从 **90Vac** 到 **264Vac**, 单相输入.

	Minimum/最小	Nominal/额定值	Maximum/最大
Input Voltage/输入电压	90Vac	100Vac~240Vac	264Vac
Input Frequency/输入频率	47Hz	60Hz/50Hz	63Hz

2.2 Input AC Current/AC 输入电流

1.3A max @ 100-240Vac input & Full load/在 **100 – 240 Vac** 输入和满载条件下最大 **1.3A** 有效值

2.3 Inrush Current (cold start)/浪涌电流(冷启动)

The inrush current will not exceed **80A** at 100-240Vac input and Max load for a cold start at **25°C**

在 100-240V 交流电输入和最大负载冷启动环境 25°C 时浪涌电流不能超过 **80A**

2.4 Average Efficiency/平均效率

While input 115Vac and 230Vac, the average efficiency is more than **88.0%**.

The test point is at 25%, 50%, 75% and 100% of max load respectively.

在输入 **115Vac** 和 **230Vac** 条件下, 平均效率不小于 **88.0%**。

测试点分别是最大载的 **25%,50%,75%**和 **100%**。

2.5 Energy Consumption /空载功耗

While input 115Vac or 230Vac and the output is no load,the input power loss must be less than **0.21W**

在输入 **115Vac/230Vac** 时,空载功耗小于 **0.21W**

SWITCHING MODE POWER SUPPLY SPECIFICATION

3. Output Characteristics/输出特性

3.1 Static Output Characteristics <Vo & R+N>/静态输出特性<输出&纹波+噪音>

Output Rate	Rated Load/额定负载		Output Range 输出电压范围	R+N 纹波与噪声	Remark 备注
	Min. Load	Max. Load			
+15V	0.0A	3.36A	14.25V-15.75V	150mVp-p	

Ripple & Noise: Measurement is done by 20MHz bandwidth oscilloscope and the output paralleled a 0.1uF ceramic capacitor and a 10uF electrolysis capacitor.

(test under the condition of rated input and rated output)

纹波与噪声: 量测时示波器选用 20MHz 带宽限制, 输出端要并联一颗 0.1uF 的陶瓷电容和一颗 10uF 的电解电容。(在额定输入及输出的条件下检测)

3.2 Line/ Load Regulation/线性/负载调整率

Output Rate	Load Condition/负载条件		Line Regulation 线性调整率	Load Regulation 负载调整率	Remark 备注
	Min. Load	Max. Load			
+15V	0.0A	3.36A	± 3%	± 5%	

3.3 Turn - on Delay Time/开机延迟时间

3S max. @ 100 Vac to 240 Vac input & Full load
在 100Vac 到 240Vac 输入和满载条件下最大 3S

3.4 Hold-up Time/关机维持时间

5mS min. @ Full load & 100Vac/60Hz input turn off at worst case
在 100Vac 输入, 满载同时最差情况下关机, 最小 5mS

3.5 Capacitance Load/容性负载

While input 100~240Vac and capacitance load is 470uF, the adapter can turn on normally and the output is in the rated range.

在输入 100~240Vac, 470uF 容性负载条件下, 适配器能正常开机。
并且输出电压范围在额定范围下。

3.6 Output Overshoot / Undershoot/输出过冲/欠冲

10% max. When the power on or off
当电源开/关机时, 10%最大

3.7 Output Load Transient Response/输出负载瞬态响应

the output shall not exceed 10% of the nominal output voltage, load fluctuation: from 20% to 80%, R/S: 0.5A/uS, frequency: 100Hz duration and 8mS at 80%.

SWITCHING MODE POWER SUPPLY SPECIFICATION

输出电压不能超过额定电压的 10%,负载变化: 从 20%到 80%, 斜率: 0.5A/uS, 频率: 100Hz, 80%负载持续时间为 8mS.

4. Protection Requirements/保护要求

4.1 Over Current Protection/过流保护

Over Current Point Limited/过流点限制: $I > 4.368A$

The output shall hiccup when the over currents applied to the output rail, and shall be self-recovery when the fault condition is removed

当过电流时, 输出将进入打嗝模式, 当过流情况解除后, 产品将会自动恢复正常

4.2 Short Circuit Protection/短路保护

The input power shall decrease when the output rail short, the power supply shall no damage, and shall be self-recovery when the fault condition is removed

当输出短路时,产品输入功率降低且不会损伤,当短路情况解除后,产品将会自动恢复正常

4.3 Over Voltage Protection/过压保护

The power supply shall protection when the output over voltage。

当输出发生过压时, 产品进入保护模式.

5. Environment Requirements/环境要求

5.1 Operating Temperature and Relative Humidity/操作温/湿度要求

0°C to +40°C

10%RH to 90%RH

5.2 Storage Temperature and Relative Humidity/存储温/湿度要求

-20°C to +80°C

5%RH to 95%RH non-condensing @ Sea level shall be low 10,000 feet/低于 10,000 英尺

5.3 Vibration/振动

10 to 300Hz sweep at a constant acceleration of 1.0G(Breadth: 3.5mm) for 1Hour for

each of the perpendicular axes X, Y, Z

扫描频率: 10 to 300Hz, 加速度: 1.0G(位移: 3.5mm), X, Y, Z 三垂直坐标轴向各振动 1 小时

5.4 Drop in/跌落

Height: 1m; the product should be fell off on the plank with the thickness of at least 53mm, and the plank should be put on the cement ground or on the ground without flexibility. Random surface in all 3 times.

跌落高度:1 米, 并跌落到厚度至少为 53mm 的木板上, 且木板应放在水泥基座或等同的无弹性地面上, 任意面共 3 次.

SWITCHING MODE POWER SUPPLY SPECIFICATION

6. Reliability Requirements/可靠性要求

6.1 Burn-in/煲机

The power supply shall be burn-in at least 4 Hours under normal input and 80% rated load at 40°C ± 5°C

产品至少要在 40°C ± 5°C 的环境及 80% 以上额定负载条件下煲机 4 小时

6.2 MTBF Qualification/平均间隔故障时间估算

The MTBF shall be at least 50,000hours at 25°C, Full load and nominal input condition

平均间隔故障时间: 至少 50,000 小时, 25°C 环境及额定输入与满载条件下

7. EMI/EMS Standards/EMI/EMS 标准

7.1 EMI Standards/EMI 标准

- | | | |
|---|---|---|
| <input type="checkbox"/> FCC Part15 class B | <input type="checkbox"/> EN55014-1 | <input type="checkbox"/> EN61204-3 (CISPR 22) |
| <input checked="" type="checkbox"/> EN55032 | <input type="checkbox"/> AS/NZS CISPR13 | <input type="checkbox"/> AS/NZS CISPR14. 1 |
| <input type="checkbox"/> AS/NZS CISPR22 | <input type="checkbox"/> GB13837 | <input type="checkbox"/> GB17625. 1 |
| <input type="checkbox"/> GB9254 | <input type="checkbox"/> J55013 | <input type="checkbox"/> J55014-1 |
| <input type="checkbox"/> J55022 | <input type="checkbox"/> KN13 | <input type="checkbox"/> KN14-1 |
| <input type="checkbox"/> KN22 | <input type="checkbox"/> CNS13438 | |

7.2 EMS Standards/EMS 标准

- | | | | |
|---|----------------------------------|------------------------------------|------------------------------------|
| <input checked="" type="checkbox"/> EN55035 | <input type="checkbox"/> EN55020 | <input type="checkbox"/> EN55014-2 | <input type="checkbox"/> EN61204-3 |
|---|----------------------------------|------------------------------------|------------------------------------|

7.2.1 IEC 61000-4-2, electrostatic discharge(ESD) requirement/静电抗扰度要求

Discharge characteristic/静电规格	Test level/测试条件	Test criteria/测试标准
Air discharge/空气放电	+/-8KV	B
Contact discharge/接触放电	+/-4 KV	B

7.2.2 IEC 61000-4-4, electric fast transients(EFT) immunity requirement/电快速瞬变脉冲群

Coupling/测试端口	Test level/测试条件	Test criteria/测试标准
AC-input/交流输入	0.5KV	A
AC-input/交流输入	1KV	B

7.2.3 IEC 61000-4-5, surge capability requirement/浪涌抗扰度要求

Surge voltage/雷击电压	Test criteria/测试标准
Differential mode/差模 +/-2KV	A
Common mode/共模 +/-2KV	

7.2.4 Assessment criteria /评估标准

SWITCHING MODE POWER SUPPLY SPECIFICATION

Acceptable criteria 可接受标准	Performance 性能
A	Performance is not allowed to be changed, any changes should be within the specified limits 性能不允许变化；如果性能会发生变化，则变化的范围在产品规格书规定的范围内。
B	During the testing process, the performance degradation is allowed within the specifications of the product specification. After the elimination, the equipment can return to normal and no reset or any manual intervention is allowed. . 设备在测试过程中，性能降低允许在产品规格书要求范围内，干扰消除后，设备能恢复正常，不允许出现复位和任何方式的人工干预。

8. Safety Standards/安规标准

8.1 Safety Accord with/安全:符合标准

- UL60950-1, CSA C22. 2 NO. 60950-1 UL62368-1, CSA C22. 2 NO. 62368-1
 UL1310
 IEC60950-1 IEC62368-1 IEC61558-1, IEC61558-2-16
 EN60950-1 EN62368-1 EN61558-1, EN61558-2-16
 AS/NZS 60950.1 AS/NZS 62368.1 AS/NZS 61558.1, AS/NZS 61558.2.16
 GB4943.1 GB8898
 J60950-1 J62368-1 J61558-1, J61558-2-16
 K60950-1 K60065
 CNS14336-1 CNS14408

Note: AC pins corresponding to relative national standards.

注：相应的 AC 插脚对应相应国家的标准。

8.2 Dielectric Strength(Hi-pot)/介电耐压强度(高压)

Primary to Secondary: **4242VDC / 5mA_{Max} / 60second**(3 seconds for mass production)

初级对次级: **4242VDC / 5mA_{Max} / 60 秒**(生产时高压测试时间: **3 秒**)

8.3 Leakage Current/漏电流

0.25mA_{max}. at 264Vac / 50Hz / 在 **264Vac / 50Hz** 输入时，最大漏电流 **0.25mA**

8.4 Insulation Resistance/绝缘阻抗

50MΩ min. at primary to secondary add 500Vdc test voltage

在初级与次级间加 **500Vdc** 进行测试,最小绝缘阻抗 **50MΩ**

SWITCHING MODE POWER SUPPLY SPECIFICATION

9. Outline Drawing/外观示意图:

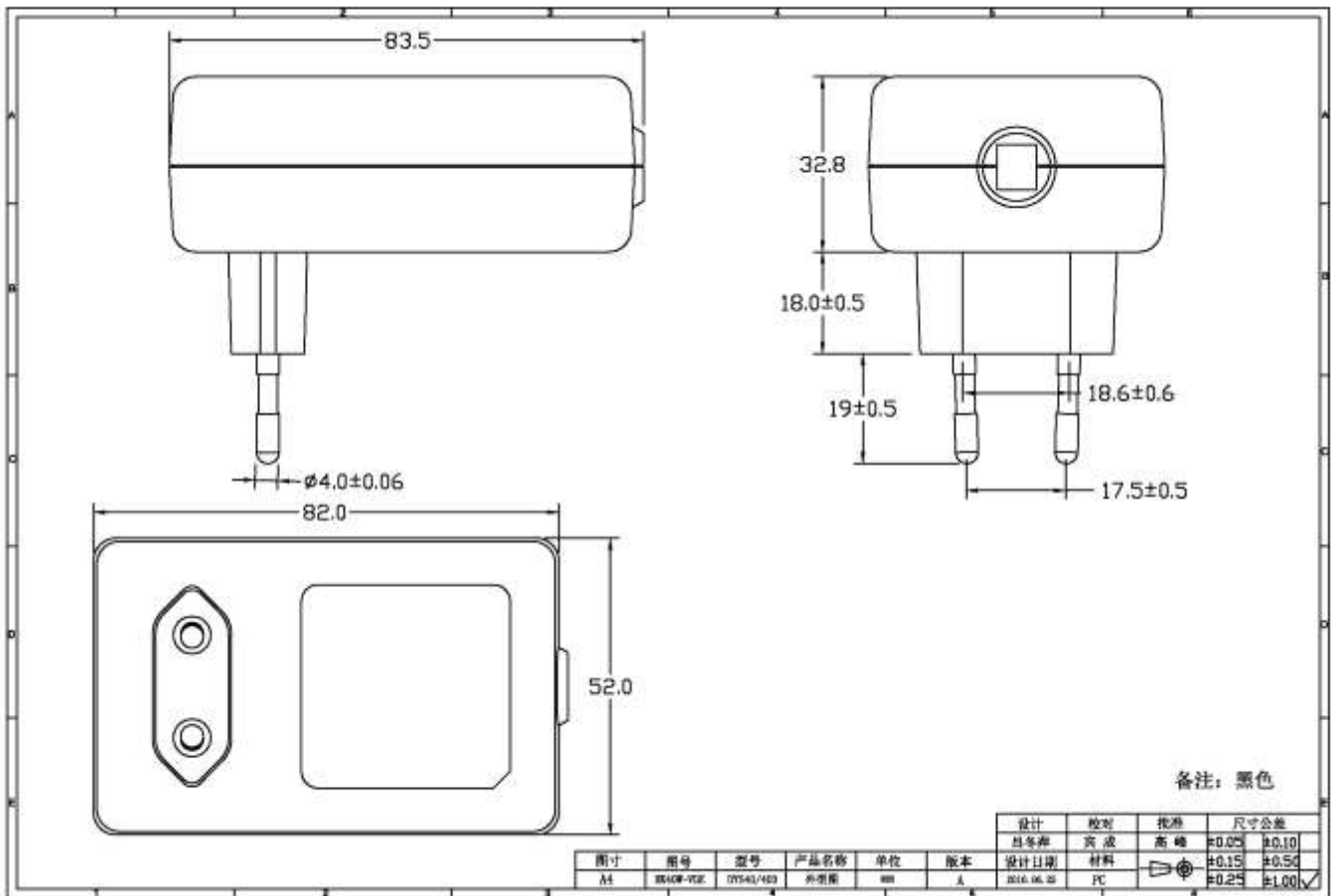

SWITCHING MODE POWER SUPPLY SPECIFICATION

10. DC Cord Drawing/DC 线示意图:

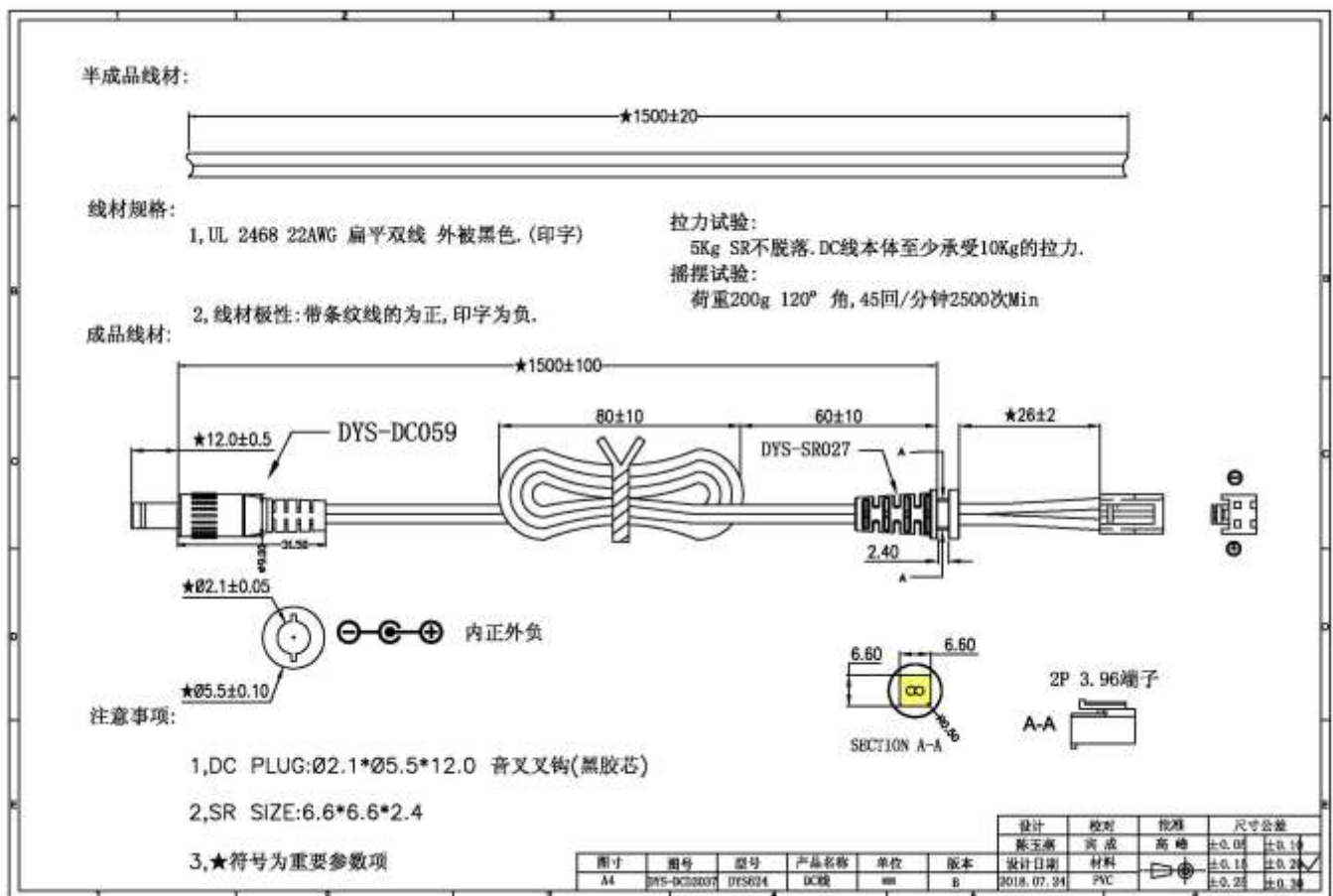

SWITCHING MODE POWER SUPPLY SPECIFICATION

11. Marking Drawing/铭牌示意图:

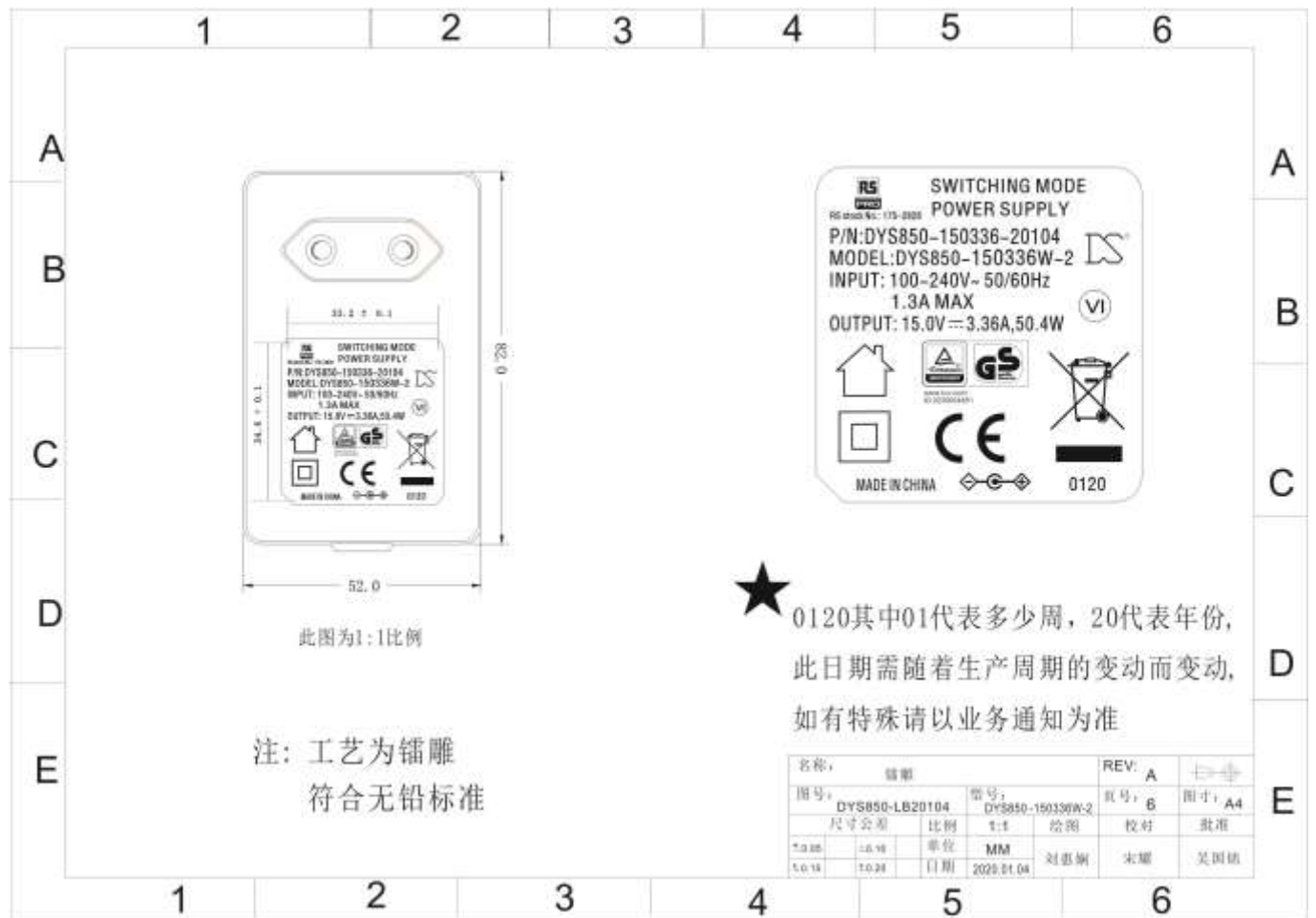

SWITCHING MODE POWER SUPPLY SPECIFICATION

12. Package Drawing/包装示意图:

PLASTIC BAG/PE袋

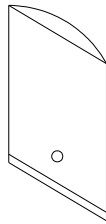

WHITE BOX/白盒

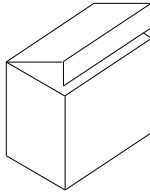

CARDBOARD/纸板

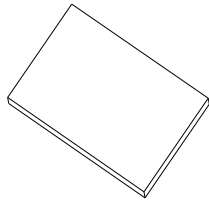

PAPER CASE/纸箱

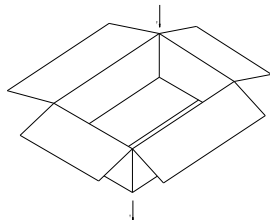

MECHANICAL DIMENSION:

	L(mm)	W(mm)	H(mm)
PLASTIC BAG	210	130	
WHITE BOX	94	60	90
CARDBOARD	398	255	
PAPER CASE	405	265	300

PACKING METHOD:

PACKING METHOD	16PCS/LAYER *3LAYERS
QTY	48PCS
N.W	11.6Kg
G.W	13.2Kg

----- END -----