

Panasonic
ideas for life

**MULTI-RANGE
ANALOG TIMER**

S1DXM-A/M



Features

- Multiple functions built in
- Part No. consolidation
(The lineup consists of 64 easy-to-choose models.)
- Cadmium-free contacts used
- Economically priced

UL US CE RoHS compliance

- Operation mode and time range switches are on front panel.
(Operation mode switch on S1DXM-M series only.)

Time selectable Mode selectable IP40

Product types

■ S1DXM-A multi-range timer

No MODE switch, Operation mode (fixed): Power ON-delay

Operating voltage	Time range	Timed-out 2 Form C	
		Part No.	Part No.
12V DC	0.05 s to 10 min	S1DXM-A2C10M-DC12V	S1DXM-A4C10M-DC12V
	0.2 s to 30 min	S1DXM-A2C30M-DC12V	S1DXM-A4C30M-DC12V
	0.5 s to 60 min	S1DXM-A2C60M-DC12V	S1DXM-A4C60M-DC12V
	0.05 min to 10 hr	S1DXM-A2C10H-DC12V	S1DXM-A4C10H-DC12V
24V DC	0.05 s to 10 min	S1DXM-A2C10M-DC24V	S1DXM-A4C10M-DC24V
	0.2 s to 30 min	S1DXM-A2C30M-DC24V	S1DXM-A4C30M-DC24V
	0.5 s to 60 min	S1DXM-A2C60M-DC24V	S1DXM-A4C60M-DC24V
	0.05 min to 10 hr	S1DXM-A2C10H-DC24V	S1DXM-A4C10H-DC24V
24V AC *Note	0.05 s to 10 min	S1DXM-A2C10M-AC24V	S1DXM-A4C10M-AC24V
	0.2 s to 30 min	S1DXM-A2C30M-AC24V	S1DXM-A4C30M-AC24V
	0.5 s to 60 min	S1DXM-A2C60M-AC24V	S1DXM-A4C60M-AC24V
	0.05 min to 10 hr	S1DXM-A2C10H-AC24V	S1DXM-A4C10H-AC24V
100 to 120V AC	0.05 s to 10 min	S1DXM-A2C10M-AC120V	S1DXM-A4C10M-AC120V
	0.2 s to 30 min	S1DXM-A2C30M-AC120V	S1DXM-A4C30M-AC120V
	0.5 s to 60 min	S1DXM-A2C60M-AC120V	S1DXM-A4C60M-AC120V
	0.05 min to 10 hr	S1DXM-A2C10H-AC120V	S1DXM-A4C10H-AC120V
200 to 220V AC	0.05 s to 10 min	S1DXM-A2C10M-AC220V	S1DXM-A4C10M-AC220V
	0.2 s to 30 min	S1DXM-A2C30M-AC220V	S1DXM-A4C30M-AC220V
	0.5 s to 60 min	S1DXM-A2C60M-AC220V	S1DXM-A4C60M-AC220V
	0.05 min to 10 hr	S1DXM-A2C10H-AC220V	S1DXM-A4C10H-AC220V
220 to 240V AC *Note	0.05 s to 10 min	S1DXM-A2C10M-AC240V	S1DXM-A4C10M-AC240V
	0.2 s to 30 min	S1DXM-A2C30M-AC240V	S1DXM-A4C30M-AC240V
	0.5 s to 60 min	S1DXM-A2C60M-AC240V	S1DXM-A4C60M-AC240V
	0.05 min to 10 hr	S1DXM-A2C10H-AC240V	S1DXM-A4C10H-AC240V

Note: 48 V DC, 100 to 110 V DC, 24 V AC and 220 to 240 V AC types are made to order. Please inquire for details.
A socket line holding clip (ADX28005) is not included with the product. Please purchase separately.

S1DXM-A/M

■ S1DXM-M multi-range timer

With MODE switch, Operation mode (switchable): Power ON-delay, Power Flicker OFF start, Power Flicker ON start, Power One-shot

Operating voltage	Time range	Timed-out 2 Form C		Timed-out 4 Form C	
		Part No.		Part No.	
12V DC	0.05 s to 10 min	S1DXM-M2C10M-DC12V		S1DXM-M4C10M-DC12V	
	0.2 s to 30 min	S1DXM-M2C30M-DC12V		S1DXM-M4C30M-DC12V	
	0.5 s to 60 min	S1DXM-M2C60M-DC12V		S1DXM-M4C60M-DC12V	
	0.05 min to 10 hr	S1DXM-M2C10H-DC12V		S1DXM-M4C10H-DC12V	
24V DC	0.05 s to 10 min	S1DXM-M2C10M-DC24V		S1DXM-M4C10M-DC24V	
	0.2 s to 30 min	S1DXM-M2C30M-DC24V		S1DXM-M4C30M-DC24V	
	0.5 s to 60 min	S1DXM-M2C60M-DC24V		S1DXM-M4C60M-DC24V	
	0.05 min to 10 hr	S1DXM-M2C10H-DC24V		S1DXM-M4C10H-DC24V	
24V AC *Note	0.05 s to 10 min	S1DXM-M2C10M-AC24V		S1DXM-M4C10M-AC24V	
	0.2 s to 30 min	S1DXM-M2C30M-AC24V		S1DXM-M4C30M-AC24V	
	0.5 s to 60 min	S1DXM-M2C60M-AC24V		S1DXM-M4C60M-AC24V	
	0.05 min to 10 hr	S1DXM-M2C10H-AC24V		S1DXM-M4C10H-AC24V	
100 to 120V AC	0.05 s to 10 min	S1DXM-M2C10M-AC120V		S1DXM-M4C10M-AC120V	
	0.2 s to 30 min	S1DXM-M2C30M-AC120V		S1DXM-M4C30M-AC120V	
	0.5 s to 60 min	S1DXM-M2C60M-AC120V		S1DXM-M4C60M-AC120V	
	0.05 min to 10 hr	S1DXM-M2C10H-AC120V		S1DXM-M4C10H-AC120V	
200 to 220V AC	0.05 s to 10 min	S1DXM-M2C10M-AC220V		S1DXM-M4C10M-AC220V	
	0.2 s to 30 min	S1DXM-M2C30M-AC220V		S1DXM-M4C30M-AC220V	
	0.5 s to 60 min	S1DXM-M2C60M-AC220V		S1DXM-M4C60M-AC220V	
	0.05 min to 10 hr	S1DXM-M2C10H-AC220V		S1DXM-M4C10H-AC220V	
220 to 240V AC *Note	0.05 s to 10 min	S1DXM-M2C10M-AC240V		S1DXM-M4C10M-AC240V	
	0.2 s to 30 min	S1DXM-M2C30M-AC240V		S1DXM-M4C30M-AC240V	
	0.5 s to 60 min	S1DXM-M2C60M-AC240V		S1DXM-M4C60M-AC240V	
	0.05 min to 10 hr	S1DXM-M2C10H-AC240V		S1DXM-M4C10H-AC240V	

Note: 48 V DC, 100 to 110 V DC, 24 V AC and 220 to 240 V AC types are made to order. Please inquire for details.
A socket line holding clip (ADX28005) is not included with the product. Please purchase separately.

Specifications

Item		Specifications						
Rating	Rated operating voltage	24VAC	100 to 120VAC	200 to 220VAC	220 to 240VAC	12VDC	24VDC	
	Rated frequency	50/60Hz common					—	
	Rated power consumption		Max. 3 VA (at 24 VAC)	Max. 3 VA (at 100 VAC)	Max. 3 VA (at 200 VAC)	Max. 3 VA (at 220 VAC)	Max. 2 W (at 12 VDC)	Max. 2 W (at 24 VDC)
		During time delay	Approx. 3mA	Approx. 3mA	Approx. 3mA	Approx. 3mA	Approx. 5mA	Approx. 3mA
		After time delay	Approx. 80mA	Approx. 20mA	Approx. 13mA	Approx. 13mA	Approx. 70mA	Approx. 40mA
	Rated control capacity	Timed -out 2 Form C: 7A 250V AC (resistive load)						
	Timed -out 4 Form C: 5A 250V AC (resistive load)							
Operation mode	S1DXM-A Power on delay operation fixed (Power display: ON/green; Operation display (when output is on): UP/orange)							
	S1DXM-M 4 switchable operations: Power ON-delay/Power Flicker OFF start/Power Flicker ON start/Power One-shot (Power display: ON/green; Operation display (when output is on): UP/orange)							
Time accuracy*1	Operating time fluctuation & Power off time change error	Within ±1%, (power off time change at the range of 0.1 s to 1 h), 1 s range: Max. ±1% and 10 ms*2						
	Voltage error	Within ±1% (at the operating voltage changes between -20 to +10%), 1 s range: Max. ±1% and 10 ms*2						
	Temperature error	Within ±5% (at 20°C 68°F ambient temp. at the range of -10 to +50°C +14 to +122°F)						
	Setting error	Within ±10%, 1 s range: Max. ±10% and 20 ms						
Contact	Contact arrangement	Timed-out 2 Form C, Timed-out 4 Form C						
	Contact resistance (Initial value)	Max. 100mΩ (at 1A, 6V DC)						
	Contact material	Timed-out 2 Form C type: Silver alloy, Au plating Timed-out 4 Form C type: Silver alloy, Au plating						
Life	Mechanical (constant)	Min. 10 ⁷						
	Electrical (constant)	2×10 ⁵ (at rated control capacity)						
Mechanical	Vibration resistance	Functional	10 to 55Hz: 1 cycle/min single amplitude of 0.25mm (10min on 3 axes)					
		Destructive	10 to 55Hz: 1 cycle/min single amplitude of 0.375mm (1h on 3 axes)					
	Shock resistance	Functional	Min. 98m/s ² (4 times on 3 axes)					
		Destructive	Min. 980m/s ² (5 times on 3 axes)					
Electrical	Allowable operating voltage range	19.2 to 26.4 V DC	80 to 132 V AC	160 to 242 V AC	176 to 264 V AC	9.6 to 13.2 V DC	19.2 to 26.4 V DC	
	Reset time	Max. 0.1s						
	Insulation resistance (Initial value)	Between live and dead metal parts, between input and output, between contact sets, between contacts Min. 100 MΩ (at 500 V DC megger)						
	Breakdown voltage (Initial value)	Between live and dead metal parts: 2,000 Vrms for 1 min Between input and output: 2,000 Vrms for 1 min Between contact sets: 2,000 Vrms for 1 min Between contacts: 1,000 Vrms for 1 min						
	Temperature rise	Max. 70°C 158°F						
Operating conditions	Ambient temperature	-10 to 50°C +14 to 122°F						
	Ambient humidity	30 to 85% RH (non-condensing)						
	Air pressure	860 to 1060 hPa						
	Ripple factor	DC type only, transmission wave rectification (ripple factor: approx. 48%)*3						
	Mass (Weight)	Approx. 45 g						
	Protective construction	IEC standard: IP40 (IP50 when using ADX18008 protective cover)						

Notes: *1. Unspecified measuring conditions are rated operating voltage (in case of DC type, ripple rate of 5% or less), ambient temp. 20°C 68°F, and power off time 1 second.

*2. Power one-shot 1 s range: +2% and 10 ms

*3. When using with a transmission wave rectification, vibration resistance and shock resistance properties worsen compared to when using a stabilized power supply.

Time range setting

Type		Time scale		Time unit		Min. scale	Max. scale	Setting range			
S1DXM-A	10M type	X1	X10	s	m	0.05	1	0.05 to 1s	0.5 to 10s	0.05 to 1m	0.5 to 10m
	30M type			s	m	0.2	3	0.2 to 3s	2 to 30s	0.2 to 3m	2 to 30m
	60M type			s	m	0.5	6	0.5 to 6s	5 to 60s	0.5 to 6m	5 to 60m
	10H type			m	h	0.05	1	0.05 to 1m	0.5 to 10m	0.05 to 1h	0.5 to 10h
S1DXM-M	10M type	X1	X10	s	m	0.05	1	0.05 to 1s	0.5 to 10s	0.05 to 1m	0.5 to 10m
	30M type			s	m	0.2	3	0.2 to 3s	2 to 30s	0.2 to 3m	2 to 30m
	60M type			s	m	0.5	6	0.5 to 6s	5 to 60s	0.5 to 6m	5 to 60m
	10H type			m	h	0.05	1	0.05 to 1m	0.5 to 10m	0.05 to 1h	0.5 to 10h

Note: The time setting range is the combination of the time scale (X1 or X10) on the dial and the time unit (s, m, or h).

Example: When dial reads 1, time scale is X1 and time units is seconds, then it is 1 second.

S1DXM-A/M

Operation mode and Time range setting

Operation mode	Operation mode switch
Power ON-delay	1 ON
	2
Power Flicker OFF start	1 ON
	2
Power Flicker ON start	1 OFF
	2
Power One-shot	1 ON
	2

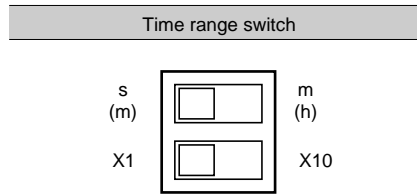

The time setting can be switched among 4 ranges each for 4 types for an interval between 0.05 seconds and 10 hours.

- Notes:
1. The product is factory shipped with all settings on the OFF side (left).
 2. Do not operate the switches with a sharp-edged object such as a knife blade.
 3. The power must be turned off when setting the time range or operation mode. Operating the switches with the power on is a cause of breakdown and malfunction.
 4. Use a force of under 5 N to operate the DIP switches when setting the time range and operation mode.

Operation mode

■ S1DXM-A multi-range timer

Power ON-delay operation

- When power is turned on, the output contact operates after the set time. The output contact remains on until the power is turned off.

Time chart

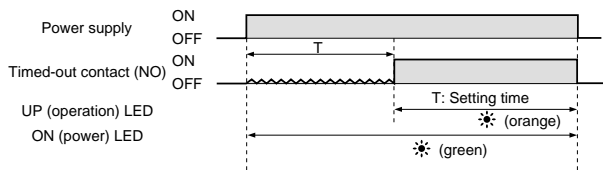

■ S1DXM-M multi-range timer

Power ON-delay operation

[MODE] switch 1: OFF, switch 2: OFF

- When power is turned on, the output contact operates after the set time. The output contact remains on until the power is turned off.

Time chart

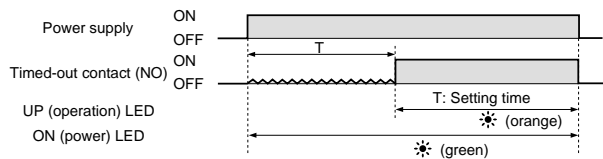

Power Flicker OFF start operation

[MODE] switch 1: OFF, switch 2: ON

- When the power is turned on, the output contacts repeatedly operate at the set time. The output contact begins from the off state.

Time chart

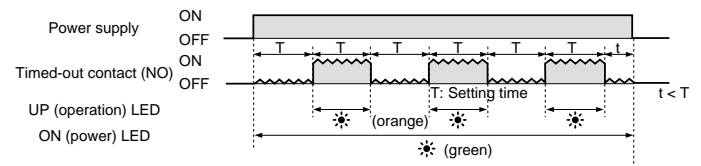

Power Flicker ON start operation

[MODE] switch 1: ON, switch 2: OFF

- When power is turned on, the output contact operates repeatedly at the set time. The output contact outputs at the same time power turns on.

Time chart

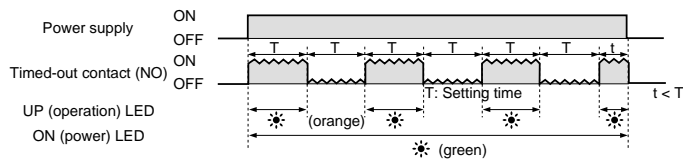

Power One-shot operation

[MODE] switch 1: ON, switch 2: ON

- When power is turned on, the output contact performs the on operation at the same time power turns on, only for the set time.

Time chart

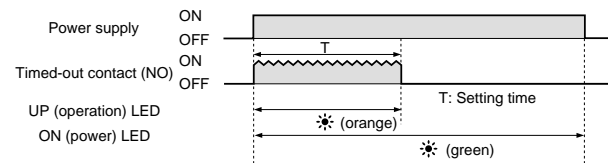

* When the power is repeatedly turned on and off, the UP (Operation) LED may light up briefly when power is applied. This is not a malfunction.

Part names

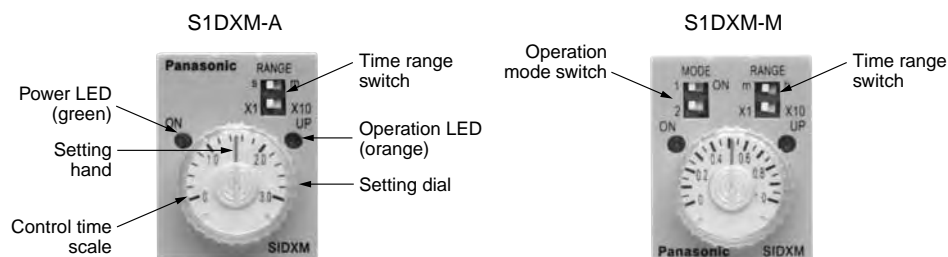

- [RANGE] Time range switch
(4 different time ranges can be switched.)
10M type: 1 s/10 s/1 min/10 min
30M type: 3 s/30 s/3 min/30 min
60M type: 6 s/60 s/6 min/60 min
10H type: 1 min/10 min/1 hr/10 hr
- [MODE] Operation mode switch
(4 different operation modes can be switched.)
Power ON-delay
Power Flicker OFF start
Power Flicker ON start
Power One-shot

Dimensions (mm inch)

The CAD data of the products with a **CAD Data** mark can be downloaded from: <http://panasonic-electric-works.net/ac>

■ S1DXM-A **CAD Data**

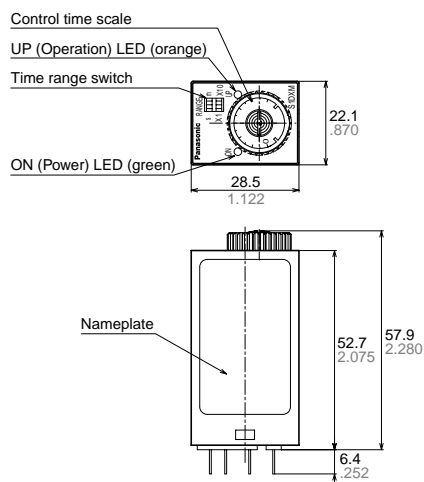

■ S1DXM-M **CAD Data**

Tolerance: $\pm 0.5 \pm 0.20$

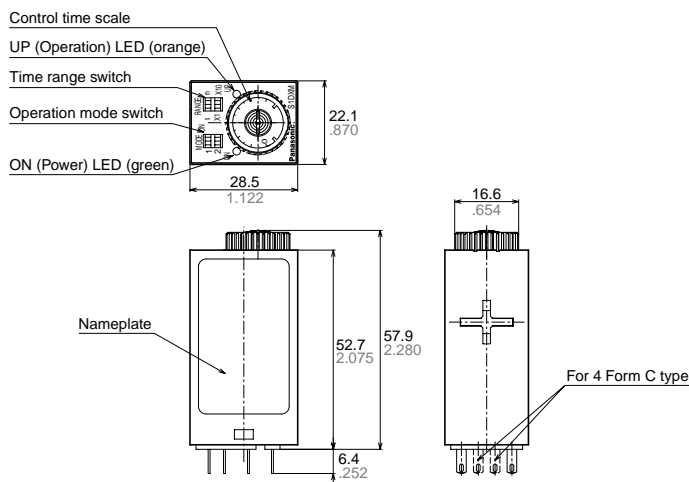

Terminal layouts and Wiring diagram

Timed-out 2 Form C type

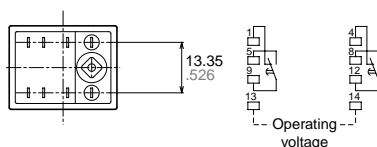

Timed-out 4 Form C type

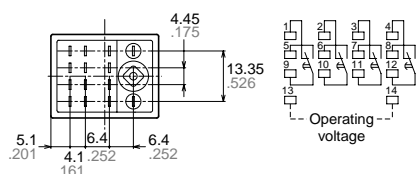

* For the DC operating type, terminal 14 is "+" and terminal 13 is "-".

Note: Please also refer to "PRECAUTIONS IN USING S1DXM-A/M AND S1DX" on page 68.

S1DXM-A/M/S1DX COMMON OPTIONS

■ Accessory (Unit: mm inch)

- Mounting frame (for panel mounting type)



ADX18002 (Titanium-gray)
ADX18006 (Gray)
ADX18007 (Black)

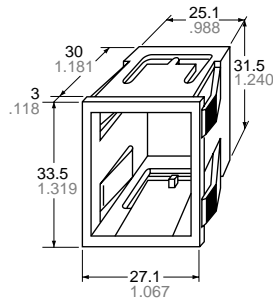

Panel cutout dimensions

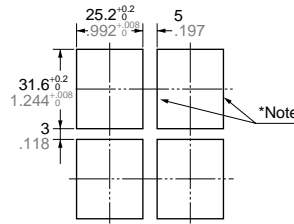

Board thickness 1 to 3 mm
Note: Make sure the holes area stays as right angles.

- Protective cover

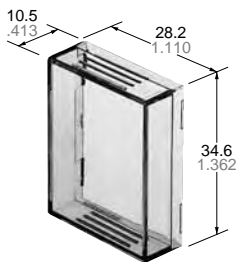

ADX18008

- Cap block

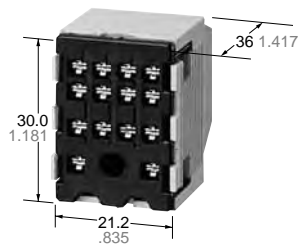

ADX18011

- Cap for cap block



ADX18004

- Socket for cap block

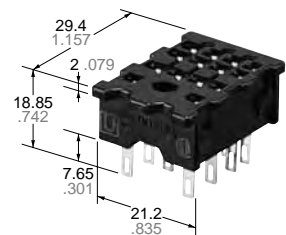

ADX18003

■ Terminal socket

- HC2 slim DIN terminal socket

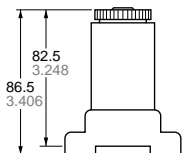

HC2-SFD-S

- HC2 DIN high terminal socket

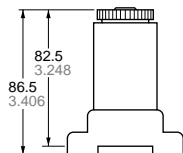

HC2-SFD-K

- HC4 DIN high terminal socket

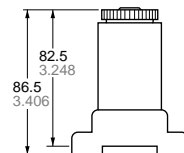

HC4-SFD-K

- HC4 socket

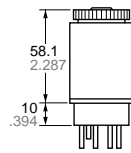

HC4-SS-K

- HJ2 terminal socket

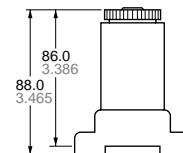

HJ2-SFD/HJ2-SFD-S

- HJ4 terminal socket

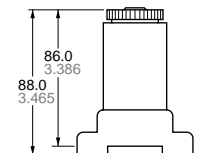

HJ4-SFD/HJ4-SFD-S

■ Socket leaf holding clip

ADX18001		ADX18012	
Appearance	Dimensions	Appearance	Dimensions
(2 pieces per set)		(2 pieces per set)	

AD68002	
Appearance	Dimensions
(2 pieces per set)	

■ Socket line holding clip for S1DXM-A/M (Sold separately)

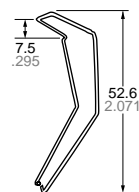

ADX28005

Terminal socket	Type	Application				
		ADX18001	ADX18012	AD68002	ADX28005 ^{*2}	ADX18005 ^{*1}
For HC relay	HC2-SFD-S ^{*3}	-	-	○	○	-
	HC2-SFD-K ^{*3}	○	-	△	○	-
	HC4-SFD-K ^{*3}	○	-	△	○	-
	HC2-SF-K	-	-	-	○	○
	HC4-HSF-K	-	-	-	○	○
	HC4-SS-K	-	-	-	○	○
For HJ relay	HJ2-SFD ^{*3}	-	○	-	-	-
	HJ2-SFD-S ^{*3}	-	○	-	-	-
	HJ4-SFD ^{*3}	-	△	-	-	-
	HJ4-SFD-S ^{*3}	-	△	-	-	-

Notes: The triangles indicate that removal will be slightly difficult when installed laterally in succession.

*1. The socket line holding clip ADX18005 is enclosed in the S1DX timer.









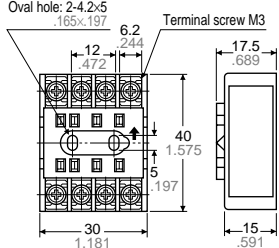

○: Available, -: Not available

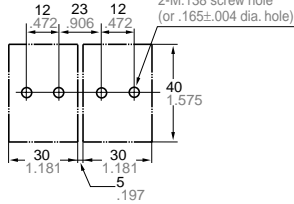
*2. The socket line holding clip (ADX28005) is not included with the S1DXM-A/M timer.

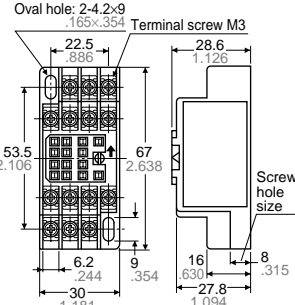
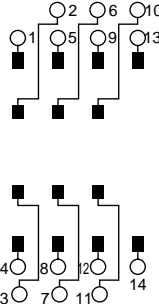
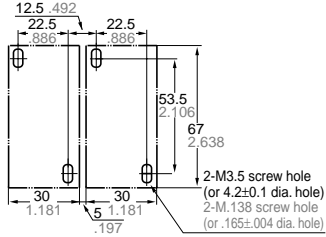
*3. For use where there is a lot of vibration and shock, please use a compliant socket leaf holding clip or socket line holding clip.

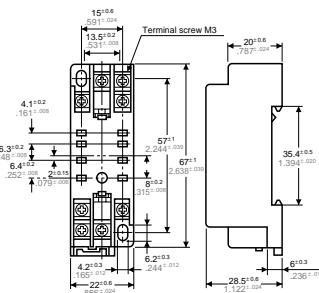
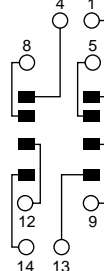
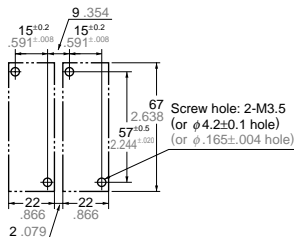

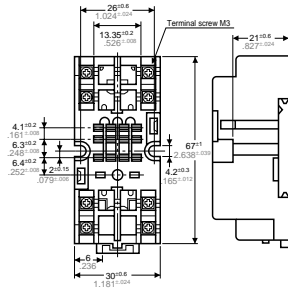
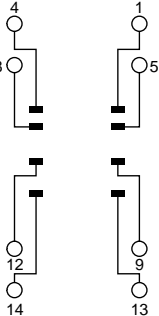
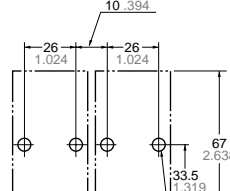

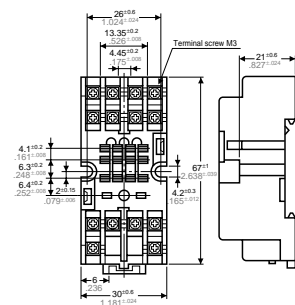
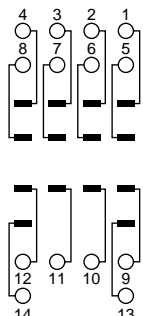
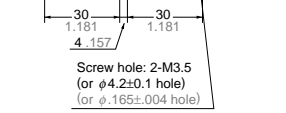

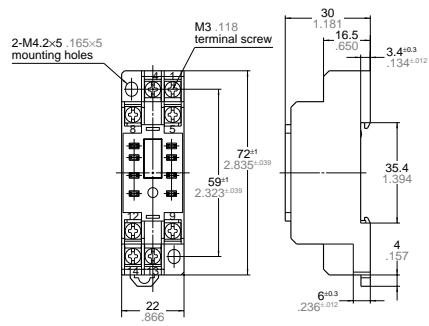
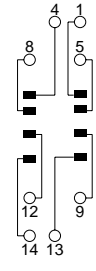
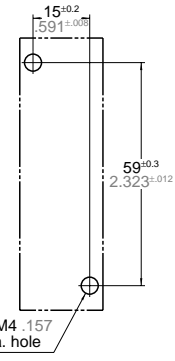

S1DXM-A/M/S1DX COMMON OPTIONS

HC relay terminal sockets

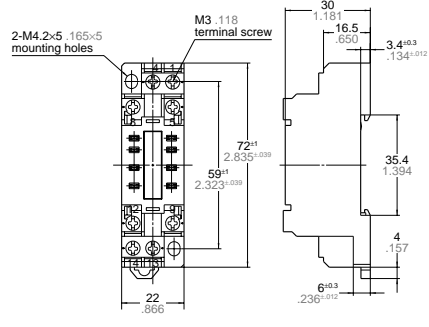
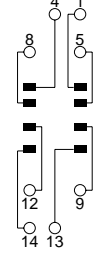
	Name/Model No.	Dimensions	Terminal layout	Mounting hole dimensions	Applicable timers	
					S1DX(2c) S1DXM(2c)	S1DX(4c) S1DXM(4c)
For general rails	<ul style="list-style-type: none"> Terminal socket, HC 2-pin  <p>HC2-SF-K</p>	 <p>Note) Only socket line holding clips can be used. (Socket leaf holding clip cannot be used.)</p>		 <p>Panel hole dimensions for side-by-side mounting</p>	Available	Not available
	<ul style="list-style-type: none"> High terminal socket, HC 1-, 2- and 4-pin  <p>HC4-HSF-K</p>	 <p>Note) Only socket line holding clips can be used. (Socket leaf holding clip cannot be used.)</p>		 <p>Panel hole dimensions for side-by-side mounting</p>	Available	Available
For DIN rails	<ul style="list-style-type: none"> Slim DIN terminal socket, HC2  <p>HC2-SFD-S</p>				Available	Not available
	<ul style="list-style-type: none"> DIN high terminal socket, HC2  <p>HC2-SFD-K</p>				Available	Not available
	<ul style="list-style-type: none"> DIN high terminal socket, HC4  <p>HC4-SFD-K</p>			 <p>Drilling size of panel holes for installing the terminal sockets parallel</p>	Available	Available

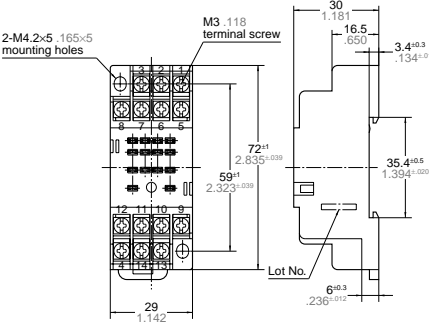
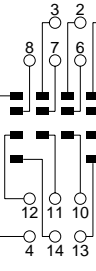
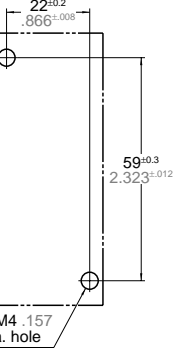
S1DXM-A/M/S1DX COMMON OPTIONS

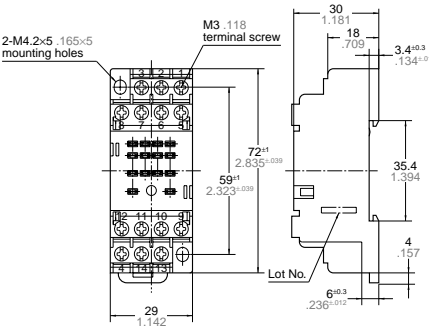
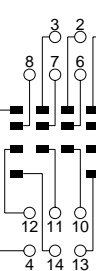
HJ relay terminal sockets

Name/Model No.	Dimensions	Terminal layout	Mounting hole dimensions	Applicable timers	
				S1DX(2c) S1DXM(2c)	S1DX(4c) S1DXM(4c)
<ul style="list-style-type: none"> HJ2 terminal socket  <p>HJ2-SFD</p>	 <p>2-M4.2x5 .165x5 mounting holes M3 .118 terminal screw 72⁺¹ 2.835^{+0.039} 59⁺¹ 2.323^{+0.039} 30 1.181 16.5 .650 3.4^{+0.3} .134^{+0.012} 35.4 1.394 4 .157 6^{+0.3} .236^{+0.012} 22 .866</p>	 <p>4 1 8 5 12 9 14 13</p>	 <p>15^{+0.2} 59⁺¹ 59^{+0.3} 2.323^{+0.012}</p>	Available	Not available
<ul style="list-style-type: none"> HJ2 terminal socket (Finger protect type)  <p>HJ2-SFD-S</p>	 <p>2-M4.2x5 .165x5 mounting holes M3 .118 terminal screw 72⁺¹ 2.835^{+0.039} 59⁺¹ 2.323^{+0.039} 30 1.181 16.5 .650 3.4^{+0.3} .134^{+0.012} 35.4 1.394 4 .157 6^{+0.3} .236^{+0.012} 22 .866</p>	 <p>4 1 8 5 12 9 14 13</p>	 <p>2-M3 .118 or M4 .157 or 4.5 .177 dia. hole 15^{+0.2} 59⁺¹ 59^{+0.3} 2.323^{+0.012}</p>	Available	Not available
<ul style="list-style-type: none"> HJ4 terminal socket  <p>HJ4-SFD</p>	 <p>2-M4.2x5 .165x5 mounting holes M3 .118 terminal screw 72⁺¹ 2.835^{+0.039} 59⁺¹ 2.323^{+0.039} 30 1.181 16.5 .650 3.4^{+0.3} .134^{+0.012} 35.4^{+0.5} 1.394^{+0.020} 4 .157 6^{+0.3} .236^{+0.012} 29 1.142 Lot No.</p>	 <p>3 2 1 8 7 6 5 12 11 10 9 4 14 13</p>	 <p>22^{+0.2} .866^{+0.008} 59^{+0.3} 2.323^{+0.012}</p>	Available	Available
<ul style="list-style-type: none"> HJ4 terminal socket (Finger protect type)  <p>HJ4-SFD-S</p>	 <p>2-M4.2x5 .165x5 mounting holes M3 .118 terminal screw 72⁺¹ 2.835^{+0.039} 59⁺¹ 2.323^{+0.039} 30 1.181 18 .709 3.4^{+0.3} .134^{+0.012} 35.4 1.394 4 .157 6^{+0.3} .236^{+0.012} 29 1.142 Lot No.</p>	 <p>3 2 1 8 7 6 5 12 11 10 9 4 14 13</p>	 <p>2-M3 .118 or M4 .157 or 4.5 .177 dia. hole 22^{+0.2} .866^{+0.008} 59^{+0.3} 2.323^{+0.012}</p>	Available	Available

S1DXM-A/M/S1DX COMMON OPTIONS

■ Sockets

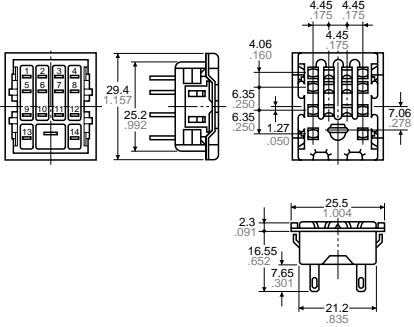
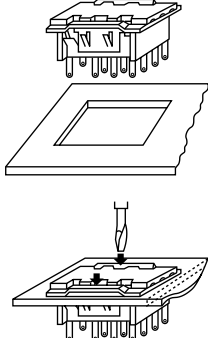
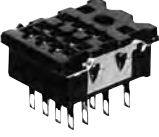
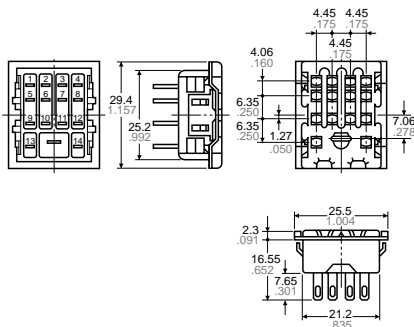
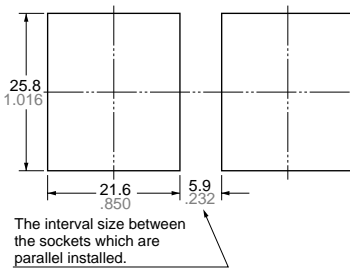
Name/Model No.	Dimensions	Mounting hole dimensions	Applicable timers	
			S1DX(2c) S1DXM(2c)	S1DX(4c) S1DXM(4c)
<ul style="list-style-type: none"> Socket, HC 2-pin  <p>HC2-SS-K</p>	<ul style="list-style-type: none"> The difference between the HC2 and HC4 sockets is only the number of the pins. Their appearances and sizes are the same. 	<ul style="list-style-type: none"> The thickness of applicable chassis plates ranges from 1.0 to 2.0 mm .039 to .079 inch. To install the socket easily, insert the socket top surface into the drilled holes and press the two points on the fastening plate indicated by arrows as shown in the fig. below. 	Available	Not available
<ul style="list-style-type: none"> Socket, HC 4-pin  <p>HC4-SS-K</p>	<p>General tolerance: $\pm 0.5 \pm 0.020$</p> 	 <p>The interval size between the sockets which are parallel installed.</p> <p>Dimensional tolerance of machining: $\pm 0.1 \pm 0.004$</p>	Available	Available

- Sockets for PC board
 - HC2-Socket for PC board: HC2-PS-K
 - HC4-Socket for PC board: HC4-PS-K

PRECAUTIONS IN USING S1DXM-A/M AND S1DX

Reset periods

After unscheduled operations have been completed, or if the timer operation power supply has been turned off at any time during operation, a reset period of at least 0.1 seconds should be allowed before resuming operation.

External surge protection

External surge protection may be required if the following values are exceeded. Otherwise, the internal circuit will be damaged. The typical surge absorption elements include a varistor, a capacitor, and a diode. If a surge absorption element is used, use an oscilloscope to see whether or not the foreign surge exceeding the specified value appears.

Single-pole, full-wave voltage for surge waveform [$\pm(1.2 \times 50)$ μ s]

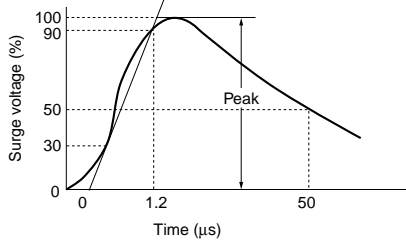

Operation voltage	Surge voltage
100 to 120V AC, 200 to 220V AC	4,000V
12V DC, 24V DC	1,000V

Since the main body cover and knob are made of polycarbonate resin, prevent contact with organic solvents such as methyl alcohol, benzene and thinner, or strong alkali materials such as ammonia and caustic soda.

Terminal wiring

Make sure that terminals are wired carefully and correctly, referring to the terminal layout and wiring diagrams. Particularly, since the DC type has polarity, do not operate it with reverse polarity.

Applicable standard

Safety standard	EN61812-1	Pollution Degree 2/Overvoltage Category II (2 Form C type) Pollution Degree 1/Overvoltage Category II (4 Form C type)
EMC	(EMI)EN61000-6-4 Radiation interference electric field strength Noise terminal voltage (EMS)EN61000-6-2 Static discharge immunity	EN55011 Group1 ClassA EN55011 Group1 ClassA
	RF electromagnetic field immunity	EN61000-4-2 4 kV contact 8 kV air
	EFT/B immunity	EN61000-4-3 10 V/m AM modulation (80 MHz to 1 GHz) 10 V/m pulse modulation (895 MHz to 905 MHz)
	Surge immunity	EN61000-4-4 2 kV (power supply line) 1 kV (signal line)
	Conductivity noise immunity	EN61000-4-5 1 kV (power supply line)
	Power frequency magnetic field immunity	EN61000-4-6 10 V/m AM modulation (0.15 MHz to 80 MHz)
	Voltage dip/Instantaneous stop/Voltage fluctuation immunity	EN61000-4-8 30 A/m (50 Hz) EN61000-4-11 10 ms, 30% (rated voltage) 100 ms, 60% (rated voltage) 1,000 ms, 60% (rated voltage) 5,000 ms, 95% (rated voltage)

Assembly

1) When installing, use a terminal socket or socket intended for HC/HJ relay. For adjacent installations, be sure to first verify the installation conditions of the terminal sockets or sockets you will be using.

2) Use the separately-sold dedicated socket leaf holding clip to secure terminal sockets and sockets to the timer unit. The conditions of use for dedicated socket leaf holding clip will differ depending on the terminal socket or socket you will be using. Therefore, please test under actual conditions before putting into operation.

3) If terminals are to be soldered directly, please hand solder with a 30 to 60 W solder iron with a tip temperature of 300°C for no more than 3 seconds. Automatic soldering should be avoided.

4) A flux-tight construction is not used with this timer, so be careful that flux or cleaning fluid does not get inside the case.

5) To assure that characteristics are maintained, do not remove the case.

Long Continuous Current Flow

Long continuous current flow through the timer cause generation of heat internally, which degrade the electronic parts. Use the timer in combination with a relay and avoid long continuous current flow through the timer. (Refer to the circuit diagram below when using a safety circuit for continuous operation.)

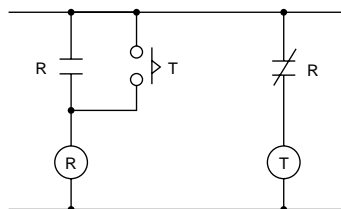

Phase synchronization using AC load

If the turning on of the timer output relay is synchronized to the AC power supply phase, there may be times when the service life is shortened because of electrical factors, or when a locking phenomenon (defective relay return) occurs because of contact point welding or a shift in the contact relay. Check the operation using the actual timer.

Acquisition of CE marking

Please abide by the conditions below when using in applications that comply with EN61812-1.

- Overvoltage category II, pollution degree 2 (2 Form C type)
Overvoltage category II, pollution degree 1 (4 Form C type)
- The load connected to the output contact should have basic insulation. This timer is protected with basic insulation and can be double-insulated to meet EN/IEC requirements by using basic insulation on the load.
- Please use a power supply that is protected by an overcurrent protection device which complies with the EN/IEC standard (example: 250 V 1 A fuse, etc.).
- You must use a terminal socket or socket for the installation. Do not touch the terminals or other parts of the timer when it is powered. When installing or uninstalling, make sure that no voltage is being applied to any of the terminals.
- Do not use this timer as a safety circuit. For example when using a timer in a heater circuit, etc., provide a protection circuit on the machine side.

PRECAUTIONS IN USING S1DXM-A/M AND S1DX

Others

- 1) When setting the time, the dial should be kept within the range indicated on the dial face. The "0" marking on the dial indicates the minimum time during which the control time can be varied (it does not indicate 0 seconds).
- 2) Do not rotate the knob past the stopper.
- 3) Turn off the power before changing the DIP switch settings. Changing the DIP switch with the power on can cause breakdown.
- 4) When connecting the operating power supply, make sure that no leakage current enters the timer. For example, when performing contact protection, if set up like that of fig. A, leaking current will pass through C and R, enter the timer, and cause incorrect operation. The fig. B shows the correct setup.

When a contact switch having an operation indicating lamp (lamp equipped limit switch, etc.) is used to apply power to the timer, a resistor having a value equal to or greater than the value below shall be connected in series with the lamp.

100 to 120V AC operating type:

Min. 33k Ω

200 to 220V AC operating type:

Min. 82k Ω

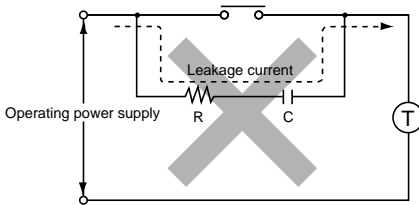
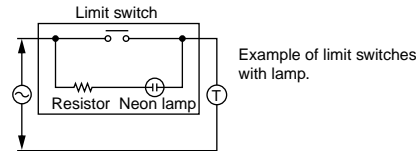

(Fig. A)

WRONG

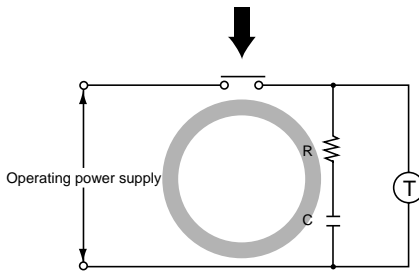

(Fig. B)

CORRECT