

Valves - Series MVU

Product code: MVU 710-1/2

Datasheet creation date: 11/12/2025 08:11

Check the most updated document online [click here](#)



TECHNICAL DATA

Mod.	MVU 710-1/2
------	-------------

Valves - Series MVU

Product code: MVU 710-1/2

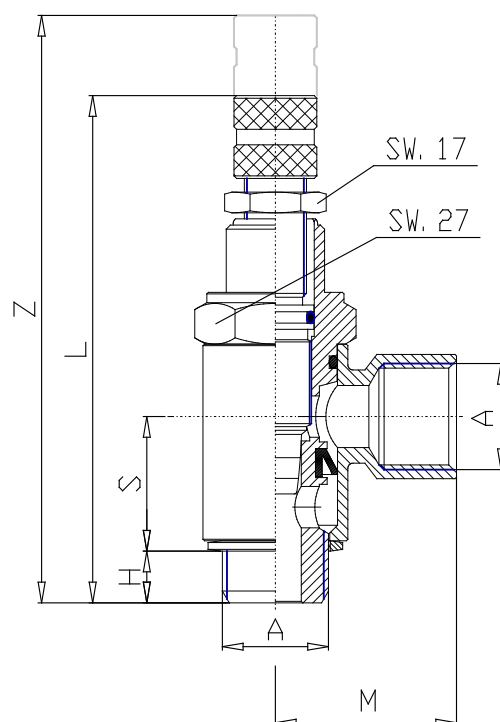

DIMENSIONS

A	1/2
H (mm)	10.0
L (mm)	98.0
S (mm)	26.0
SW (mm)	27
SW1 (mm)	17.0
Z (mm)	113.5
M (mm)	35