

## DETAILS

<b>Product Number</b>	CP12412_LOS-RS
<b>Family</b>	Leila
<b>Type</b>	Assembly
<b>Color</b>	white
<b>Diameter</b>	21,6 mm
<b>Height</b>	14,3 mm
<b>Style</b>	round
<b>Optic Material</b>	PMMA
<b>Holder Material</b>	PC
<b>Fastening</b>	pin, glue
<b>Status</b>	ready
<b>ROHS Compliant</b>	Yes
<b>Date Updated</b>	6/11/2015

## OPTICAL PROPERTIES

LED	Viewing	Light	Effi-	cd/lm	Connector
	Angle	Beam	ciency		
Oslo SSL 150	6 deg	Real spot	93 %	40.000	-
Oslo SSL 80	7 deg	Real spot	93 %	29.800	-
Oslo Square EC	10 deg	Real spot	94 %	20.900	-



D

C

B

A

4

4

6.2

LED position

4.7

∅ 2

Bottom view

8.6

C / C

3

3

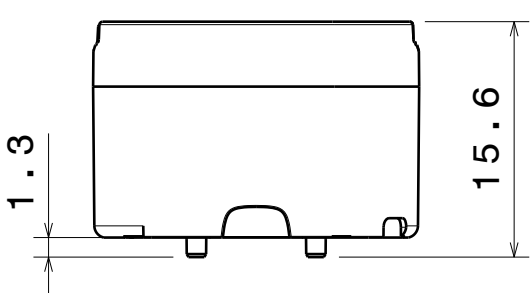
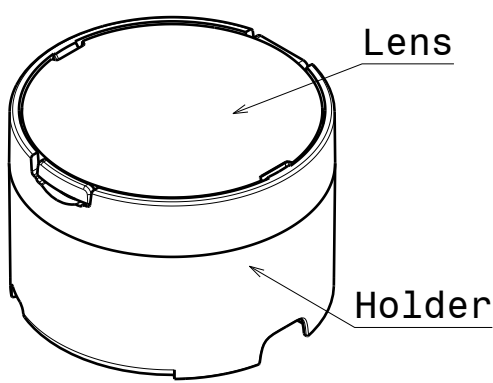

2

2

∅ 21.56

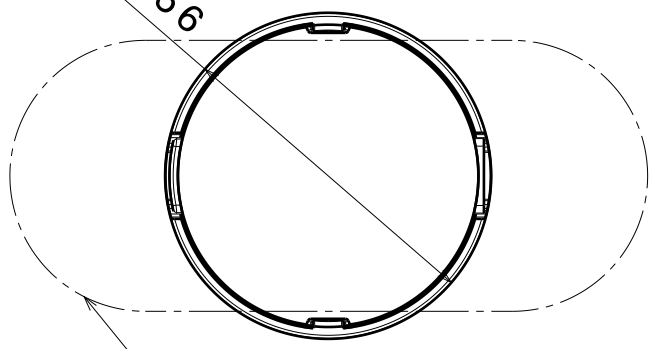

Oval-version beam direction, 0-90 turned 90 degree

Tolerances if not otherwise shown  
According to DIN ISO 2768-1  
Linear measures:  
Up to 30mm class M, otherwise class C.  
According to DIN ISO 2768-2  
Form and position: class L

**LEDiL** LediL Oy  
Salorankatu 10  
FIN 24240 SALO  
Finland

THIRD ANGLE PROJECTION:

DRAWING TITLE  
**CP12412\_LOS-RS**

This drawing is the property of LEDiL Oy. It may not be reproduced, copied or communicated without a written agreement with LEDiL Oy."

SIZE	PART NUMBER
A4	CP12412

SCALE	2:1	WEIGHT	-	SHEET	1/1
-------	-----	--------	---	-------	-----

D

A

1

Luminaire: LEDIL OY CP12412\_LOS-RS (SSL150) Efficiency=93%  
Lamps: 1 x Osram Oslon SSL150 (95lm@250mA)

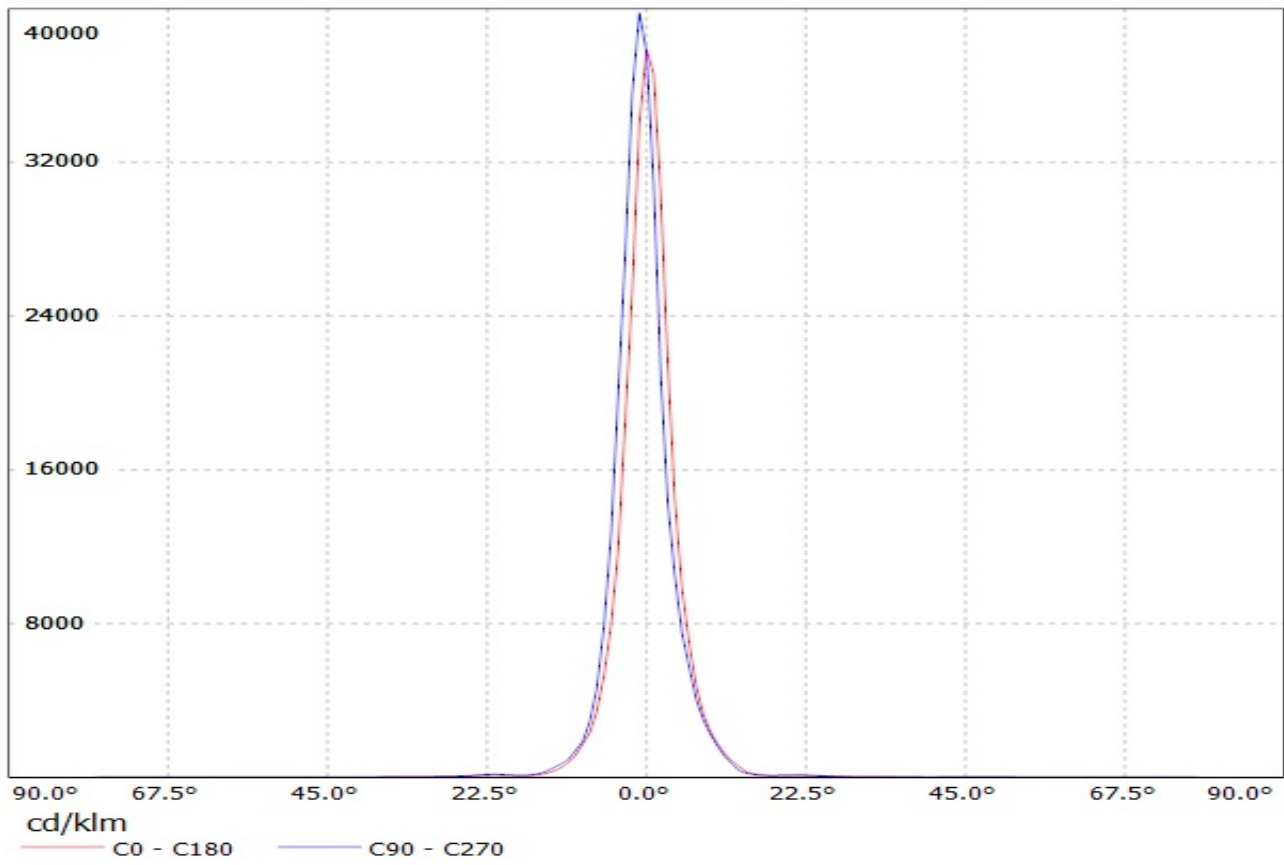

Luminaire: Ledil Oy CA12412-LOS-RS\_OSL80 LOR=93%  
Lamps: 1 x Osram OS180 250mA 85lm

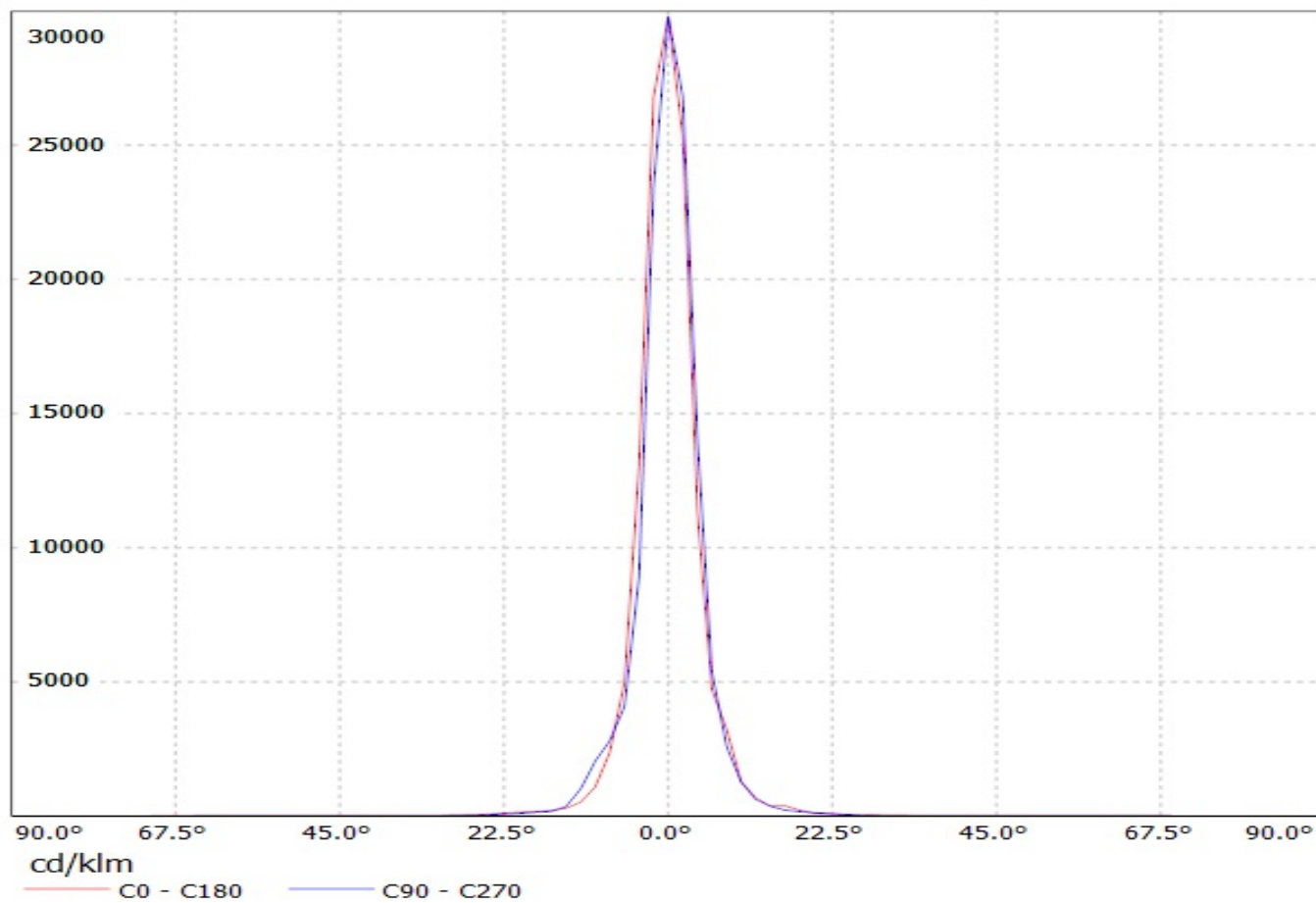

Luminaire: LEDIL OY CP12412\_LOS-RS (SSL150) Efficiency=93%  
Lamps: 1 x Osram Oslon SSL150 (95lm@250mA)

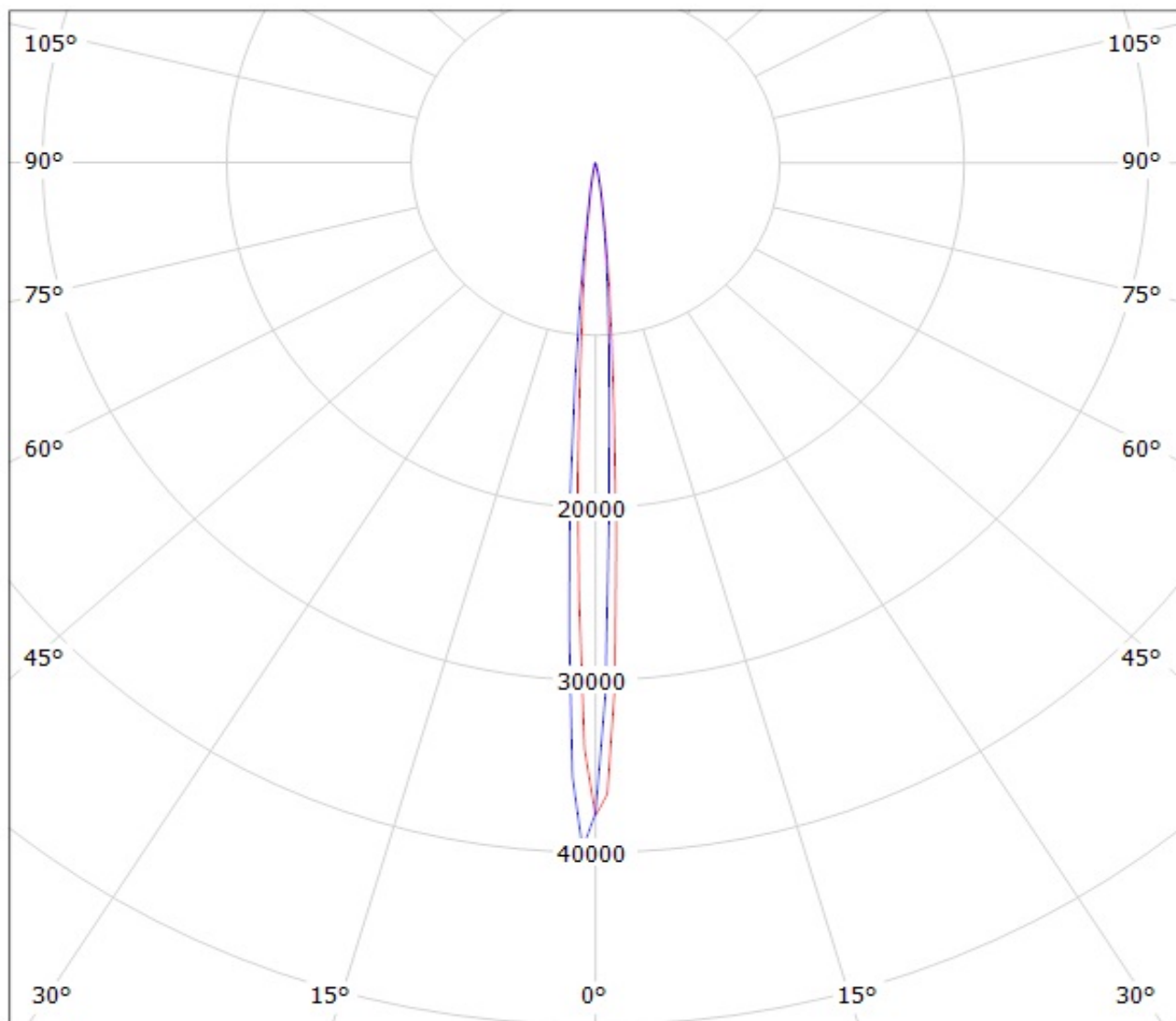

cd/klm

— C0 - C180

— C90 - C270

Luminaire: Ledil Oy CA12412-LOS-RS\_OSL80 LOR=93%  
Lamps: 1 x Osram OSI80 250mA 85lm

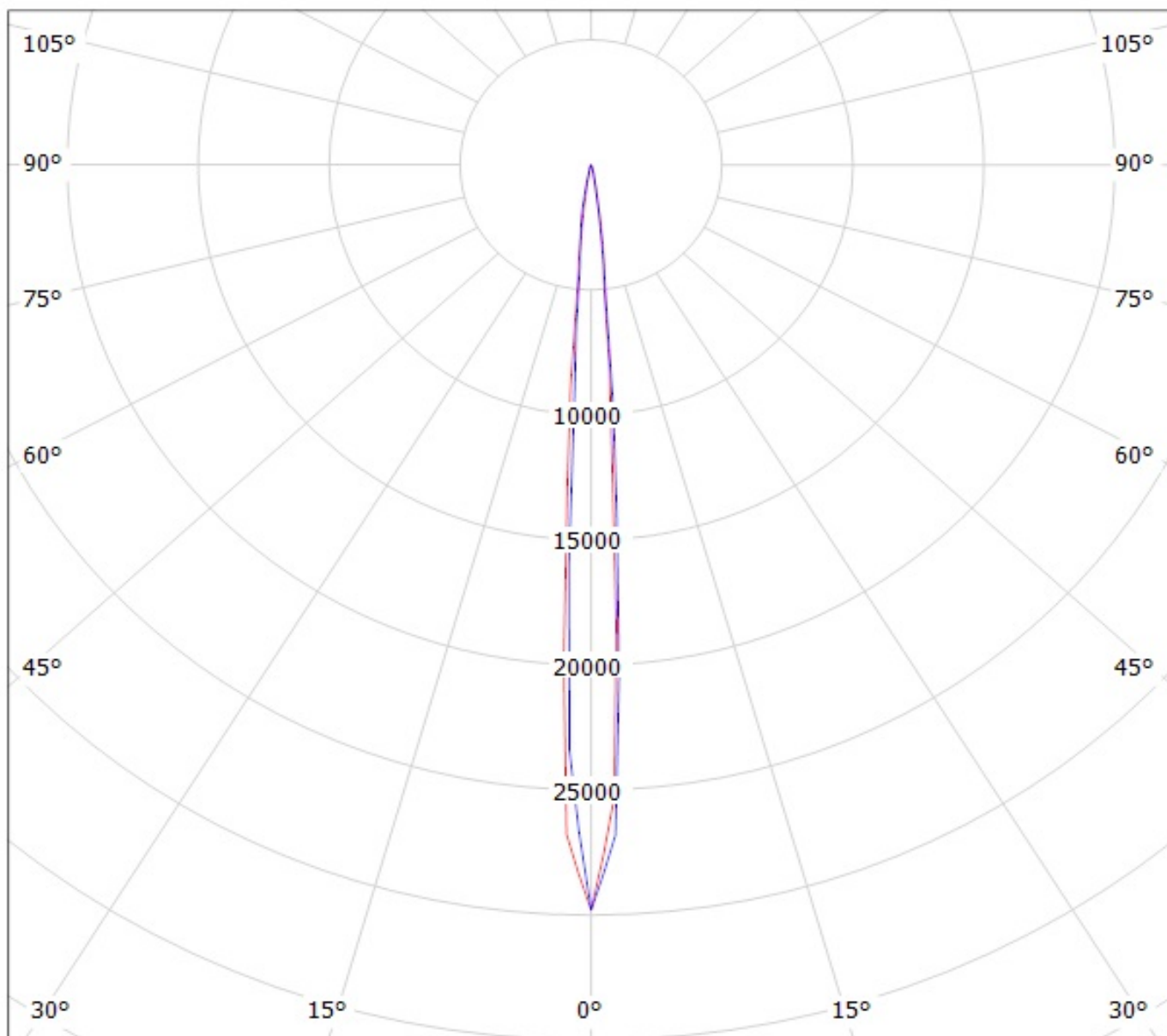

cd/klm

— C0 - C180

— C90 - C270

**NOTE: The typical divergence will be changed by different color, chip size and chip position tolerance. The typical total divergence is the full angle measured where the luminous intensity is half of the peak value.**