

POLIAMMIDE 6 + POLIURETANO COLATO

- Rivestimento in poliuretano colato, durezza 95±3 Shore A.
- Nucleo in poliammide 6 di prima scelta.
- Elevata portata, scorevolezza, silenziosità; massima resistenza agli urti, all'abrasione e alle sostanze corrosive; facilità di pulizia.
- Temperatura di impiego: -30°C / +80°C.
- Mozzo con: cuscinetti a sfere di precisione, schemati; cuscinetto a rullini standard o inox; foro passante.

POLYAMIDE 6 + CAST POLYURETHANE

- Cast polyurethane coating, hardness 95±3 Shore A.
- Core in high quality polyamide 6.
- High load capacity; smooth and noiseless running; high resistance to shocks, abrasion and corrosion; easy to clean.
- Temperature range: -30°C / +80°C (-22°F / +176°F).
- Hub with: shielded precision ball bearings; standard or stainless steel roller bearing; plain bore.

POLYAMID 6 + POLYURETHAN (GEGOSSEN)

- Beschichtung aus Guss-Polyurethan, Härte 95±3 Shore A.
- Radkern aus Polyamid 6 - 1. Wahl.
- Hohe Tragkraft; niedriger Rollwiderstand; geräuschloser Lauf; hohe Stoßfestigkeit; abrieb- und korrosionsfest; leichte Reinigung
- Arbeitstemperatur: -30°C / +80°C.
- Lagerung: abgeschirmte Präzisions-Rillenkugellager; standard oder rostfreies Rollenkorblager; Gleitlager.

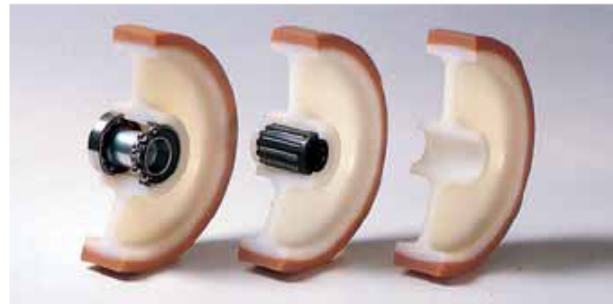

POLYAMIDE 6 + POLYURETHANE COULÉ

- Bandage en polyuréthane coulé, dureté 95±3 Shore A.
- Corps en polyamide 6 première choix.
- Pour charges élevées; silencieuse; faible résistance au roulement; très élevée résistance aux chocs, à l'usure et à la corrosion; facilité de nettoyage.
- Température d'emploi: -30°C / +80°C (-22°F / +176°F).
- Moyeu avec: roulements à billes de précision protégés; roulement à rouleaux inox ou standard; alésage lisse.

POLIAMIDA 6 + POLIURETANO COLADO

- Revestimiento en poliuretano colado, dureza 95±3 Shore A.
- Núcleo en poliamida 6 de primera calidad.
- Para cargas elevadas, facilidad de rodadura, muy silenciosa; máxima resistencia a los golpes, a la abrasión y a las sustancias corrosivas; se limpia fácilmente.
- Temperatura de empleo: -30°C / +80°C (-22°F / +176°F).
- Cubo con: cojinetes a bolas de precisión, protegidos; cojinete a rodillos standard o inox; agujero liso.

	D	80	100	100	125	125	150	175	200	200	225	225	275
	E	24	30	40	30	40	40	40	50	50	50	50	60



CUSCINETTI A SFERE DI PRECISIONE - PRECISION BALL BEARINGS - PRÄZISIONS-RILLENKUGELLAGER ROULEMENTS À BILLES DE PRÉCISION - COJINETES A BOLAS DE PRECISION

Art. N.	-	4501	4571	4502	4572	4574	4504	4507	4505	4509	4506	4508
	X	80	80	100	100	125	150	175	175	200	200	250
	d	15	15	15	15	15	20	20	25	20	25	25
	s	35	35	35	35	35	47	47	52	47	52	52
	t	12,2	12,2	12,2	12,2	12,2	17	17	17	17	17	17
	V	38	38	38	38	46	44	54	56	54	56	56
	L	40	40	40	40	50	50	60	60	60	60	60
	M	47	47	46	46	50	63	69	69	63	71	82
	Kg.	200	250	250	300	400	500	600	600	700	700	1000

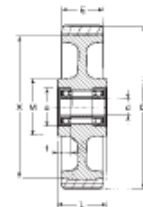

CUSCINETTO A RULLINI STANDARD O INOX - STANDARD OR STAINLESS STEEL ROLLER BEARING - STANDARD ODER ROSTFREIES ROLLENKORBLAGER - ROULEMENT À ROULEAUX STANDARD OU INOX - COJINETE A RODILLOS STANDARD O INOX

Art. N.	-	4511	4561	4512	4562	4513	4514	4517	4515	4519	4516	4518	STANDARD
Art. N.	-	4511/x	4561/x	4512/x	4562/x	4513/x	4514/x	4517/x	4515/x	4519/x	4516/x	4518/x	INOX
	d	15	15	15	15	20	20	20	25	20	25	25	
	L	40	40	40	40	50	50	60	60	60	60	74	
	M	37	47	38	46	43	49	55	55	57	57	66	
	Kg.	200	250	250	300	400	500	600	600	700	700	1000	

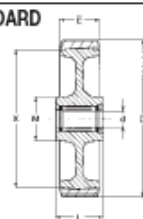

FORO PASSANTE - PLAIN BORE - GLEITLAGER - ALÉSAGE LISSE - AGUJERO LISO

Art. N.	4520	4521	4591	4522	4592	4523	4524	4527	4525	4529	4526	4528
	d	10	15	15	15	20	20	20	25	20	25	25
	L	26	40	40	40	40	50	50	60	60	60	74
	M	22	28	29	29	29	36	37	44	44	46	55
	Kg.	120	200	250	250	300	400	500	600	600	700	1000

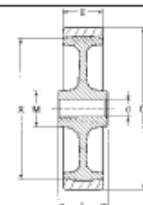

LAG**ADINYL + P60**

PESANTI - HEAVY - SCHWERLAST - LOURDES - PESADOS

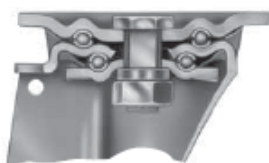

Art. N. "FV"



Art. N. "FR"



	D	100	100	125	150	175	200	225	
	E	40	40	40	40	40	50	50	

SUPPORTI GIREVOLI - SWIVEL CASTORS - LENKROLLEN - ROULETTES PIVOTANTES - CONJUNTOS GIRATORIOS

Art. N.	19854	19855	19861	19866	19869	19871	19873		
	d	15	15	15	15	20	20	20	
Art. N.	19879	19880	19886	19891	19894	19896	19898		
	d	15	15	15	20	20	20	20	
Art. N.	19904	19905	19911	19916	19919	19921	19923		
	d	15	15	15	20	20	20	20	

SUPPORTI FISSI - FIXED CASTORS - BOCKROLLEN - ROULETTES FIXES - CONJUNTOS FIJOS

Art. N.	19929	19930	19936	19941	19944	19946	19948		
	d	15	15	15	15	20	20	20	
Art. N.	19954	19955	19961	19966	19969	19971	19973		
	d	15	15	15	20	20	20	20	
Art. N.	19979	19980	19986	19991	19994	19996	19998		
	d	15	15	15	20	20	20	20	

DATI TECNICI - TECHNICAL DATA - TECHNISCHE DATEN - DONNÉES TECHNIQUES - DATOS TECNICOS

	H	138	139	164	195	236	250	293	
	AxB	105x85	135x110	135x110	135x110	135x110	135x110	135x110	
	axb	80x80	105x80	105x80	105x80	105x80	105x80	105x80	
	g	6	10	10	10	12	12	12	
	F	42	42	42	50	66	66	71	
	U	50	50	50	50	60	60	60	
		FR	FR	FR	FR	FR/FV	FR/FV	FR/FV	
	Kg.	250	250	300	400	500	600	700	

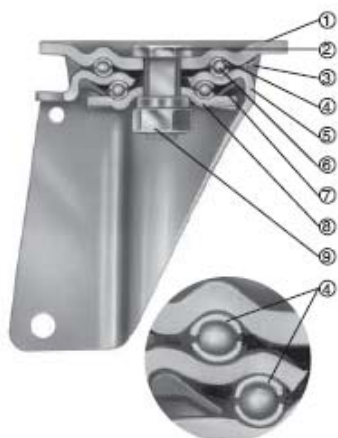

SUPPORTI PESANTI P60

- Finitura: zincatura elettrolitica bianca
- 1) Piastra d'attacco in lamiera d'acciaio stampata
- 2) Perno centrale ribadito alla piastra
- 3) Anello parapolvere in materiale termoplastico (water resistant)
- 4) Ralle contenimento sfere in acciaio temperato
- 5) Corpo girevole in lamiera d'acciaio stampata
- 6) Sfere d'acciaio temperato
- 7) Guarnizione di tenuta in materiale termoplastico (water proof)
- 8) Anello tenuta sfere in lamiera d'acciaio stampata
- 9) Dado autobloccante

HEAVY DUTY CASTORS P60

- Finish: electro-zinc plated, white.
- 1) Top plate in pressed steel-sheet.
- 2) Kingpin riveted to the top-plate.
- 3) Thermoplastic dust protection ring (water resistant).
- 4) Hardened steel ball races.
- 5) Swivel fork in pressed steel sheet.
- 6) Hardened steel balls.
- 7) Thermoplastic dust seal (water proof).
- 8) Balls retaining ring in pressed steel-sheet.
- 9) Self-locking nut.

SCHWERLAST GEHÄUSE P60

- Finish: elektro-verzinkt, weiß
- 1) Einbauplatte aus gepresstem Stahlblech
- 2) Auf der Platte eingewinkelter Königsbolzen
- 3) Wasserabweisender Staubring aus thermo-plastischem Kunststoff
- 4) Kugelbahnen aus gehärtetem Stahlblech
- 5) Lenkgabel aus gepresstem Stahlblech
- 6) Gehärtete Stahlkugeln
- 7) Wasser- und Staubabdichtungsring aus thermo-plastischem Kunststoff
- 8) Kugelhalterring aus gepresstem Stahlblech
- 9) Selbstsichernde Mutter

CHAPES LOURDES P60

- Finition: électrozingué, blanc
- 1) Platine de fixation en tôle d'acier emboutie.
- 2) Pivot central rivé à la platine.
- 3) Anneau pare-poudre en matière thermoplastique (résistant à l'eau).
- 4) Cuvettes porte-billes en acier trempé
- 5) Fourche pivotante en tôle d'acier emboutie
- 6) Billes en acier trempé
- 7) Joint étanche en matière thermoplastique
- 8) Anneau porte billes en tôle d'acier emboutie
- 9) Ecrou de sûreté

SOPORTES PESADOS P60

- Acabado: electro-cincado, blanco.
- 1) Platina de anclaje en chapa de acero estampada.
- 2) Perno central remachado a la platina.
- 3) Anillo anti-polvo en material termoplastico (water-resistant).
- 4) Pistas de rodadura en acero templado.
- 5) Horquilla giratoria en chapa de acero estampada.
- 6) Bolas en acero templado.
- 7) Junta estanca en material termoplastico.
- 8) Disco porta bolas en chapa de acero estampada.
- 9) Tuerca autobloqueante.

D	80-100	80-100	125	125	150-160	150-160	175-180-200	225-230-250
U	50	50	50	60	50	60	60	60
Art.	06010	06012	06022	06030	06042	06060	06070	06080
Art.	06110	06112	06122	06130	06142	06160	06170	06180
H	126-138	129-139	164	174	195-200	203-208	236-240-250	293-295-305
AxB	105x85	135x110	135x110	135x110	135x110	135x110	135x110	135x110
axb	76x55 80x60	96x56 105x75 105x80	96x56 105x75 105x80	105x75 105x80	96x56 105x75 105x80	105x75 105x80	105x75 105x80	105x75 105x80
g	8	10	10	12	10	12	12	12
F	42	42	42	53	50	64	66	71
O	10	10	10	14	10	14	14	14
FR*	FR*	FR*	FR	FR	FR	FR	FR	FR
FV	-	-	-	FV	-	FV	FV	FV
Kg.	450	450	450	650	450	650	860	800

Per articoli con freno aggiungere FR o FV al codice (vedere anche pag. 21) - To order items with brakes add FR or FV to part number (see also page 21) - Für gebremste Ausführungen FR bzw. FV zur Bestellnummer beifügen (siehe auch Seite 21) - Pour versions à frein ajouter FR ou FV à la référence produit (voir aussi page 21) - Para artículos con freno añadir FR o FV al código (vean también la pag. 21).

* Idoneo per impiego con freno solo con ruota Ø 100 mm - Suitable for use with brake only with wheel Ø 100 mm - Anwendung mit Totlaststeller nur mit Rad Ø-100 mm möglich - Apte pour utilisation avec frein uniquement avec roue Ø 100 mm - Idóneo para empleo con freno sólo con rueda Ø 100 mm.

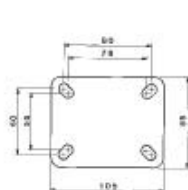

Ø 80-100/50L

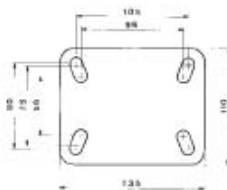

Ø 80-100/50-160/50

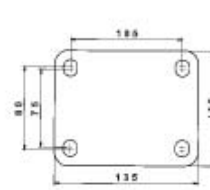

Ø 125/60-250/60

**P60 - M40 - M20
INOX 40 - INOX 20**

FR



FRENO ANTERIORE A PEDALE - Blocca contemporaneamente la rotazione della ruota e del supporto. È applicato ai supporti girevoli P60, M40 e M20 (molla in acciaio dacrometizzato) e Inox 40, Inox 20 (molla in acciaio inox AISI 301). Nei supporti P60, M40 e Inox 40 il freno è regolabile. Per articoli con freno aggiungere FR al codice.

TRAILING FOOT BRAKE - Locks wheel and swivel simultaneously. It is fitted to swivel castors P60, M40 and M20 (dacromet steel spring) and Inox 40, Inox 20 (AISI 301 stainless steel spring). The brake on castors P60, M40 and Inox 40 is adjustable. To order items with brake add FR to part number.

FUSS-FESTSTELLER IN NACHLAUF - Blockiert Räd und Lenkung gleichzeitig. Ausführung für Lenkgehäuse P60, M40 und M20 (Feder aus Stahl mit dacromet Schutz) und Inox 40, Inox 20 (Feder aus Edelstahl AISI 301). Die Ausführung für P60, M40 und Inox 40 Gehäuse ist nachstellbar. Für Rollen mit Totalfeststeller FR zur Bestell-Nr beifügen.

FREIN AVANT A PEDALE - Bloque en même temps la roue et le pivotement. Appliqué aux chapes pivotantes P60, M40 et M20 (ressort en acier dacromet) et Inox 40, Inox 20 (ressort en acier inox AISI 301). Le frein des chapes P60, M40 et Inox 40 est réglable. Pour articles avec frein ajouter FR au code.

FRENO ANTERIOR DE PIÉ - Bloquea simultaneamente el soporte y la rueda. Aplicado a los soportes giratorios P60, M40 y M20 (muelle en acero dacromet) y Inox 40, Inox 20 (muelle en acero inox AISI 301). En los soportes P60, M40 y Inox 40 el freno es ajustable. Para artículos con freno añadir FR al código.



		R	
M20 - Inox 20:	∅ 60/40-125/40	108 mm	Kg. 0,110
	∅ 100/50-160/50	140 mm	Kg. 0,180
	∅ 160/60-200/60	168 mm	Kg. 0,260
P60 - M40 - Inox 40:	∅ 100/50-160/50	140 mm	Kg. 0,270
	∅ 125/60-250/60	170 mm	Kg. 0,470

E70 - P60 - M40

FV



FRENO POSTERIORE A PEDALE - Blocca contemporaneamente la rotazione della ruota e del supporto. Leveraggio a snodo senza molle. È munito di vite di regolazione. Per articoli con freno aggiungere FV al codice.

LEADING FOOT BRAKE - Locks wheel and swivel simultaneously. Leverage without springs. Is adjustable by means of a screw. To order items with brake add FV to part number.

FUSS-FESTSTELLER IN VORLAUF - Blockiert Räd und Lenkung gleichzeitig. Hebefunktion ohne Feder. Mit Einstellschraube. Für Rollen mit Totalfeststeller FV zur Bestell-Nr beifügen.

FREIN ARRIER A PEDALE - Bloque en même temps la roue et le pivotement. Système de leviers sans ressort. Equipé d'une vis de réglage. Pour articles avec frein ajouter FV au code.

FRENO POSTERIOR DE PIÉ - Bloquea simultaneamente el soporte y la rueda. Sistema de levas sin muelle. Dotado de tornillo de regulación. Para artículos con freno añadir FV al código.



		R	
E70:	∅ 150/60-200/60	150 mm	Kg. 0,500
P60 - M40:	∅ 125/60-250/60	150 mm	Kg. 0,500

E70 - P60 - M40 - M20

BLOCCAGGIO DIREZIONALE - Blocca la rotazione del supporto nella direzione del senso di marcia. Interasse fori: 80 mm.

DIRECTIONAL LOCK - Locks the swivel in the direction of motion. Bolt hole spacing: 80 mm.

RICHTUNGSFESTSTELLER - Lenksperre in Laufrichtung. Schraublochentfernung: 80 mm.

BLOPAGE DIRECTIONNEL - Bloque le pivotement dans la direction de marche. Entr'axe des trous de fixation: 80 mm.

BLOQUEO DIRECCIONAL - Bloquea el rodamiento del soporte en la dirección de marcha.

Distancia entre centros: 80 mm.



		Art. N.	
M20:	∅ 125/50-160/50	P3935	Kg. 0,390
	∅ 160/60-200/60	P3960	Kg. 0,390
M40 - P60:	∅ 125/50-160/50	P3935	Kg. 0,390
	∅ 125/60-250/60	P3940	Kg. 0,390
E70:	∅ 150/60-200/60	P3945	Kg. 0,390

G80



BLOCCAGGIO DIREZIONALE A DUE POSIZIONI

Si aziona manualmente, blocca la rotazione del supporto in due punti a 180°. Aggiungere B2 al codice.

DIRECTIONAL LOCK

Manually operated, locks the swivelling of the castor in two points at 180°. Add B2 to partnumber.

RICHTUNGSFESTSTELLER

Hand betätigt, blockiert die Lenkung der Gehäuse auf zwei Punkte zu 180°. Beifügen B2 zur Bestellnummer.

BLOPAGE DIRECTIONNEL

Actionné manuellement, arrête le pivotement de la chape sur deux points à 180°. Ajouter B2 à la référence produit.

BLOQUEO DIRECCIONAL

Accionado manualmente, bloquea el girar de la horquilla en dos puntos a 180°. Añadir B2 al código.

G80:	∅ 125-150/105	∅ 300/153
	∅ 200/126	∅ 300/132+132
	∅ 250/153	∅ 400/132+132
	∅ 250/100+100	
E70:	∅ 300/153	

ORGANI DI ROTOLAMENTO - BEARINGS - LAGERUNG - ORGANS DE ROULEMENT - ORGANOS DE RODAMIENTO

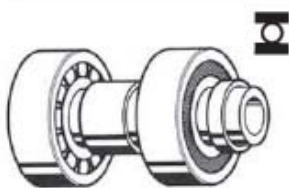

Cuscinetti a sfere schermati da un lato e bussola di riduzione in tubo di acciaio trafilato con distanziali in acciaio zincato: per usi continui ai massimi carichi.

Shielded precision ball bearings, with reduction bush of drawn steel tube and spacers of zincplated steel: for continuous applications at highest loads.

Präzisions-Rillenkugellager, einseitig abgeschirmt, mit Reduktionshülse aus gezogenem Stahl und Distanzröhren aus verzinktem Stahl: für Dauerbetrieb unter Höchstbelastung.

Roulements à billes protégés sur un côté, entretoise de réduction en tube d'acier trafilé, et bague entre-roulements en acier zingué: pour usage continu aux charges plus élevées.

Cojinetes a bolas de precision protegidos por el lado exterior, casquillo de reducción en tubo de acero trafilado y separadores internos y externos en acero cincado: para usos continuos a las máximas cargas.

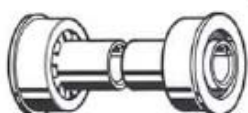

Cuscinetti a sfere schermati di costruzione speciale per le ruote BETA: per usi con frequente movimentazione ai massimi carichi consentiti delle ruote.

Shielded ball bearings of special design for wheels series BETA: for frequent usage at maximum wheel loading.

Abgeschirmte Rillenkugellager im Sonderkonstruktion für BETA Räder: für häufigen Lauf unter höchstmöglicher Belastung der Räder.

Roulements à billes de construction speciale pour les roues BETA: pour usage fréquent aux charges plus élevées admis par les roues.

Cojinetes a bolas de construcción especial para las ruedas BETA: para usos frecuentes a las máximas cargas permitidas para esta rueda.

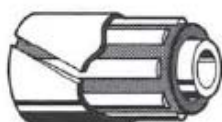

Cuscinetto a rullini temperati e rettificati, con pista di rotolamento in acciaio temperato e bussola in tubo di acciaio temperato: per usi continui ai massimi carichi.

Hardened and rectified roller bearing, with hardened steel sleeve and bush of hardened steel tube: for continuous applications at highest loads.

Rollenkorblager, gehärtet und geschliffen, mit gehärteter Laubbuchse und gehärteter Reduktionshülse: für Dauerbetrieb unter Höchstbelastung.

Roulement à rouleaux trempés et rectifiés, avec piste de roulement en acier trempé et entretoise en tube d'acier trempé: pour usage continu aux charges plus élevées.

Cojinete a rodillos templados y rectificados con pista de rodadura en acero templado y casquillo de reducción en tubo de acero templado: para usos continuos a las máximas cargas.

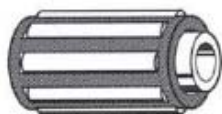

Cuscinetto a rullini standard e bussola in tubo di acciaio: per impiego in ambienti normali.

Standard roller bearing and steel bush: for applications in normal environments.

Rollenkorblager, standard, und Reduktionshülse aus Stahlrohr: für Betrieb unter normalen Bedingungen.

Roulement à rouleaux standard et entretoise en tube acier: pour usage dans un milieu normal.

Cojinete a rodillos standard y casquillo de reducción en tubo de acero: para usos en ambientes normales.

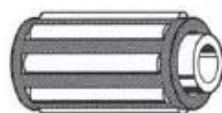

Cuscinetto a rullini Inox AISI 304 e bussola in acciaio inox AISI 304: per impiego in presenza di sostanze corrosive.

Stainless steel roller bearing AISI 304 and stainless steel bush AISI 304: for applications in corrosive environments.

Rollenkorblager, rostfrei, aus Edelstahl AISI 304 mit Reduktionshülse aus Edelstahl AISI 304: für Betrieb bei Korrosionsmitteln.

Roulement à rouleaux Inox AISI 304 et entretoise en acier inox AISI 304: pour usage en presence de substances corrosives.

Cojinete a rodillos Inox AISI 304 y casquillo de reducción en acero inox AISI 304: para usos en ambientes corrosivos.

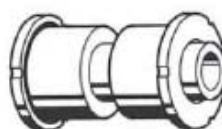

Boccole in poliammide 6 autolubrificante e bussola di riduzione in tubo di acciaio o acciaio inox AISI 304: per usi intermittenti.

Self-lubricating polyamide 6 bushes and steel or stainless steel AISI 304 reduction bush: for intermittent use.

Buchsen aus Polyamid 6, selbstschmierend, und Reduktionshülse aus Stahl oder Edelstahl AISI 304: für zeitbegrenzten Betrieb.

Bagues en Polyamide 6 autolubrificante et entretoise en acier ou acier inox AISI 304: pour usage intermittent.

Buje en poliamida 6 autolubrificante y casquillo de reducción en tubo de acero o acero inox AISI 304: para usos intermitentes.



Foro passante e bussola di riduzione in tubo di acciaio o acciaio inox AISI 304: per usi intermittenti.







Plain bore and reduction bush obtained from a steel tube or inox AISI 304: for intermittent use.

Gleitlager und Reduktionshülse aus Stahl oder aus Edelstahl AISI 304: für zeitbegrenzten Betrieb.

Alésage lisse et entretoise de réduction en tube acier ou acier inox AISI 304: pour usage intermittent.

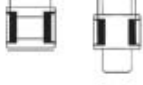
Agujero liso y casquillo de reducción en tubo de acero o acero inox AISI 304: para usos intermitentes.

SIMBOLI - SYMBOLS - SYMBOLE - SYMBOLES - SIMBOLOS

	D	Diametro ruota Wheel diameter Radurchmesser Diamètre de la roue Diámetro de la rueda		axb	Interasse fori di fissaggio Bolt hole spacing Lochabstand Entr'axe des trous de fixation Distancia entres centros
	E	Larghezza del battistrada Tyre width Reifenbreite Largeur du bandage Ancho de bandaje		g	Diametro bullone di fissaggio Fixing bolt diameter Durchmesser der Befestigungsschraube Diamètre des boulons de fixation Diámetro perno de fijación
	N	Larghezza totale Track width Gesamtbreite Largeur totale Ancho total		PxQ	Dimensioni perno di fissaggio Dimensions of fixing stem Zapfen-Größe Dimensiones de la tige Dimensiones del perno
	X	Diametro del nucleo Wheel centre diameter Radkörperdurchmesser Diamètre du corps de roue Diámetro del núcleo		U	Larghezza forcella Fork width Gabelbreite Largeur de la fourche Ancho de la horquilla
	s	Diametro sede cuscinetti Bearing seat diameter Kugellagersitzdurchmesser Diamètre siège du roulement à billes Diámetro alojamiento cojinetes		O	Diametro bullone assale Diameter of axle hole Achsenraubendurchmesser Diamètre du boulon de l'essieu Diámetro de la tuerca del eje
	t	Profondità sedi cuscinetti Bearing seat depth Kugellagersitz-Tiefe Profondeur siège du roulement à billes Profundidad alojamiento cojinetes			Supporto girevole a piastra Top-plate swivel fork assembly Lenkgehäuse mit Platte Chape pivotante à platine Soporte giratorio con platina
	V	Scartamento esterno cuscinetti Outer faces bearings distance Aussen Lagerabstand Ecartement extérieur des roulements Largo externo entre cojinetes			Supporto fisso a piastra Top-plate fixed fork Bockgehäuse mit Platte Chape fixe à platine Soporte fijo con platina
	L	Larghezza mozzo Hub width Nabenlänge Longueur du moyeu Largo del cubo			Supporto girevole a foro passante Swivel fork assembly Lenkgehäuse mit Rückenloch Chape pivotante à trou central Soporte giratorio con taladro pasador
	M	Diametro mozzo Hub diameter Nabendurchmesser Diamètre du moyeu Diámetro del cubo			Supporto girevole a perno Swivel stem fork assembly Lenkgehäuse mit Zapfen Chape pivotante à tige Soporte giratorio con perno
	d	Diametro foro Bore diameter Achsl Lochdurchmesser Diamètre de l'alséage Diámetro del agujero			Freno e/o bloccaggio totale Total braking and/or locking device Totalfeststeller Blocage total Freno integral
	H	Altezza totale Overall height Gesamthöhe Hauteur totale Altura total			Freno e/o bloccaggio totale anteriore Trailing total braking and/or locking device Totalfeststeller nachlaufend Blocage total avant Freno integral anterior
	C	Corsa massima del bilancere Maximum equalizer's deflection Höchster Federlauf Course maximal du balancier Desplazamiento máximo del balancín			Freno e/o bloccaggio totale posteriore Leading total braking and/or locking device Totalfeststeller vortlaufend Blocage total arrière Freno integral posterior
	daN	Precarico della molla Preload Vorspannkraft Precharge du ressort Precarga del resorte		kg	Portata Load capacity Tragfähigkeit Capacité de charge Carga
	F	Disassamento Offset Ausladung Déport Desplazamiento			Cuscinetti a sfere Ball bearings Präzision Kugellager Roulements à billes Cojinetes a bolas
	R	Raggio di ingombro Swept radius Umlaufradius Rayon d'encombrement Radio de viraje			Cuscinetto a rullini Roller bearing Rollenkorblager Roulement à rouleaux Cojinete a rodillos
	AxB	Dimensioni esterne della piastra Top plate outer dimensions Platten-Außenmaße Dimensions extérieures de la platine Dimensiones exteriores de la platina			Foro passante o boccoia Plain bore Gleitlager Alésage lisse Agujero liso

		POLIURETANO & VULKOLLAN		POLYURETHANE & VULKOLLAN		POLYURETHAN & VULKOLLAN		POLYURÉTHANE & VULKOLLAN		POLIURETANO & VULKOLLAN	
		POLIURETANO TERMOPLASTICO		THERMOPLASTIC POLYURETHANE		THERMOPLASTICHER POLYURETHAN		POLYURÉTHANE THERMOPLASTIQUE		POLIURETANO TERMOPLASTICO	
		GOMMA		RUBBER		GUMMI		CAOUTCHOUC		GOMA	
		POLIAMMIDE		POLYAMIDE		POLYAMID		POLYAMIDE		POLIAMIDA	
		COMPATIBILITÀ CHIMICA		CHEMICAL COMPATIBILITY		CHEMISCHE BESTÄNDIGKEIT		COMPATIBILITÉ CHIMIQUE		COMPATIBILIDAD QUÍMICA	
--	--	+	++	Acetato di etile	Ethyl acetate	Äthylacetat	Acétate d'éthyle	Acetato de etil			
--	--	++	++	Acetone	Acetone	Aceton	Acétone	Acetona			
--	-	++	--	Acido acetico	Acetic acid	Essigsäure	Acide acétique	Acido acético			
--	--	+	--	Acido acetico glaciale	Acetic acid glacial	Eisessigsäure	Acide acétique glacial	Acido acético glacial			
+	--	+	--	Acido cloridrico	Hydrochloric acid	Salzsäure	Acide chlorhydrique	Acido clorídrico			
--	--	+	--	Acido cloridrico conc.	Hydrochloric acid conc.	Salzsäure Konz.	Acide chlorhydrique conc.	Acido clorídrico			
--	/	--	-	Acido cromico	Chromic acid	Chromsäure	Acide chromique	Acido cromico			
+	+	+	--	Acido formico	Formic acid	Ameisensäure	Acide formique	Acido fórmico			
/	-	++	--	Acido fosforico	Phosphoric acid	Phosphorsäure	Acide phosphorique	Acido fosfórico			
/	-	++	-	Acido lattico	Lactic acid	Milchsäure	Acide lactique	Acido lácteo			
-	--	-	--	Acido nitrico	Nitric acid	Salpetersäure	Acide nitrique	Acido nítrico			
-	--	-	--	Acido solforico	Sulphuric acid	Schwefelsäure	Acide sulfurique	Acido sulfúrico			
++	++	++	++	Acqua	Water	Wasser	Eau	Agua			
--	/	--	+	Acqua di cloro	Chlorine water	Chlorwasser	Eau chlorée	Agua clorada			
++	-	+	--	Acqua ossigenata	Hydrogen peroxide	Wasserstoffsperoxyd	Eau oxygénée	Agua oxigenada			
--	--	--	--	Acqua regia	Aqua regia	Königswasser	Eau régale	Agua regia			
+	+	++	++	Alcol etilico	Ethyl alcohol	Äthylalkohol	Alcool ethylique	Alcohol etílico			
-	--	++	++	Alcol metilico	Methyl alcohol	Methylalkohol	Alcool methylique	Alcohol metílico			
--	/	++	++	Aldeide formica	Formaldehyde	Formaldehyd	Formaldéhyde	Aldehido fórmico			
--	/	+	+	Anilina	Aniline	Anilin	Aniline	Anilina			
+	--	--	++	Benzina	Gasoline	Benzin	Essence	Gasolina			
--	/	--	--	Bromo	Bromine	Brom	Brome	Bromo			
++	+	++	++	Carbonato di sodio	Sodium carbonate	Natriumcarbonat	Carbonate de sodium	Carbonato de sodio			
--	--	--	--	Cloro	Chlorine	Chlor	Chlore	Cloro			
--	--	--	+	Cloro benzene	Chlorobenzene	Chlorbenzol	Chlorebenzéne	Clorobenceno			
--	--	--	--	Cloroformio	Chloroform	Chloroform	Chloroforme	Cloroformo			
--	--	--	+	Cloruro di metilene	Methylene dichloride	Methylenchlorid	Chlorure de méthylène	Cloruro de metileno			
+	/	++	+	Cloruro di nichel	Nickel chloride	Nickelchlorid	Chlorure de nickel	Cloruro de níquel			
+	/	+	++	Cloruro di sodio	Sodium chloride	Natriumchlorid	Chlorure de sodium	Cloruro de sodio			
--	/	--	++	Cloruro di vinile	Vinyl chloride	Vinylchlorid	Chlorure de vinyle	Cloruro de vinilo			
--	--	--	--	Cresolo	Cresols	Kresole	Crésol	Crisol			
--	--	++	++	Dimetilformammide	Dimethylformamide	Dimethylformamid	Diméthylformamide	Dimetilformamida			
+	+	--	++	Esano	Hexane	Hexan	Hexane	Hexano			
/	+	/	++	Etere di petrolio	Petroleum ether	Erdöläther	Éther de pétrole	Eter de petróleo			
+	++	+	--	Glicole etilenico	Ethylene glycol	Äthylenglykol	Glycol éthylénique	Etilenglicol			
--	/	++	+	Idrossido di potassio	Potassium hydroxide	Kaliumhydroxyd	Hydroxyde de potassium	Hidróxido de potasio			
+	--	+	++	Idrossido di sodio	Sodium hydroxide	Natriumhydroxyd	Hydroxide de sodium	Hidróxido de sodio			
--	-	++	++	Ipclorito di sodio	Sodium hypochlorite	Natriumhypochlorit	Hypochlorite de sodium	Hipoclorito de sodio			
++	++	++	++	Latta	Milk	Milch	Lait	Leche			
--	--	--	++	Metil-etilchetone	Methylethylketone	Methyläthylketon	Méthyle éthyle cétone	Metil-etilcetona			
+	+	++	++	Nitrato di sodio	Sodium nitrate	Natriumnitrat	Nitrate de sodium	Nitrato de sodio			
++	++	--	++	Oli minerali	Mineral oils	Mineralöle	Huiles minéral	Aceite mineral			
++	/	--	++	Oli vegetali	Vegetable oils	Pflanzlicheöle	Huiles végétales	Aceite vegetal			
++	--	--	++	Olio di paraffina	Paraffin oil	Paraffinöl	Huile de paraffine	Aceite de parafina			
+	+	--	++	Olio diesel (nafta)	Diesel oil	Dieselöl	Huile diesel	Aceite diesel			
++	/	--	--	Ozono	Ozone	Ozon	Ozone	Ozono			
+	/	--	++	Petrolio	Petrol	Erdöl	Pétrole	Petróleo			
++	/	+	++	Solfato di rame	Copper sulphate	Kupfersulfat	Sulfate de cuivre	Sulfato de cobre			
--	--	--	++	Trementina	Turpentine	Terpentin	Térébenthine	Trementina			
--	--	--	++	Tricloroetilene (trielina)	Trichloroethylene	Trichloräthylen	Trichloréthylène	Tricloroetileno			
+	+	+	+	Vapore	Steam	Dampf	Vapeur	Vapor			

++	Resistente	Resistant	Beständig	Résistant	Resistente
+	Discretamente resistente	Fairly resistant	Fair beständig	Moyennement résistant	Discretamente resistente
+	Probabilmente resistente	Probably resistant	Wahrscheinlich beständig	Probablement résistant	Probablemente resistente
-	Discretamente attaccato	Fairly attached	Wahrscheinlich angegriffen	Moyennement attaqué	Discretamente apegado
--	Non resistente	Not resistant	Nicht beständig	Non-résistant	No resistente
/	Nessun dato	No data available	Keine Information	Pas de données	No datos