

CAD FILE S8742741.DGN  
 DWG. NO. SD 87427-\*\*\*4\*

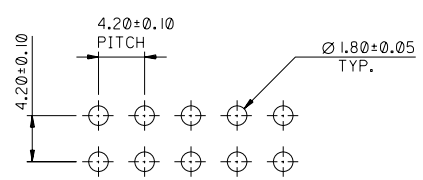

**RECOMMENDED P.C.B. LAYOUT**

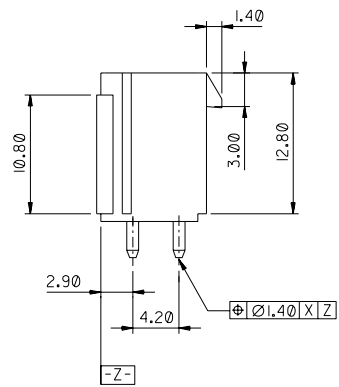
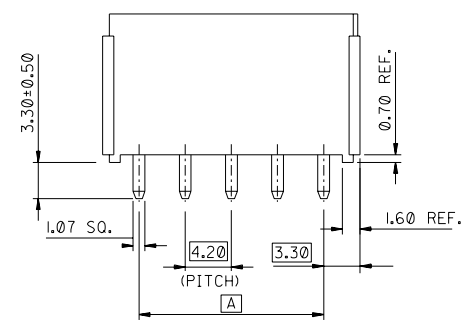
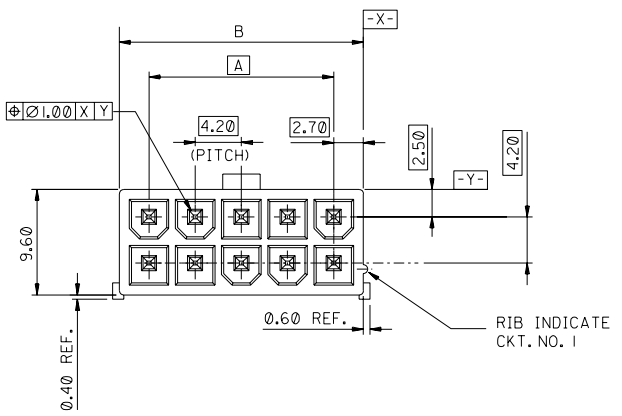
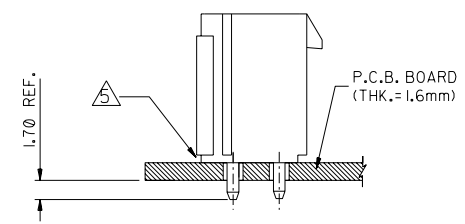

**RECOMMENDED INSTALLATION PATTERN**

**LEGEND**  
 87427-\*\*\*4\*  
 CKT. SIZE [Symbol] PLATING OPTIONS  
 2 = NOTE 2  
 3 = NOTE 3  
 8 = NOTE 4

**NOTES**

1. MATERIAL - HOUSING : NYLON 46, UL94V-0, COLOR BEIGE  
 PIN : BRASS (1.07 SQUARE)
2. PLATING OF PIN  
 TIN 2.54um MIN. OVER NICKEL 1.27um MIN.
3. PLATING OF PIN  
 TIN 4-10um OVER COPPER 2-8um.
4. PLATING OF PIN  
 GOLD 0.76um MIN. OVER NICKEL 1.27um MIN.
5. HOUSING STANDOFF (0.70 mm REF.)

				MATERIAL :		MOLEX SINGAPORE PTE LTD	
				SEE NOTES		SHEET 1 OF 2	
C	ADDED TOL FOR DIM 'B'	I2004-0095	S.S	030904	FINISH :		
B	ADD GOLD-PLATED PIN OPTION	S70623	SAMC	970630			
A	RELEASE TO SALES	S60393	SAMC	960401	SEE NOTES		
2	PRELIMINARY RELEASE	-----	SAMC	960315			
1	PRELIMINARY RELEASE	-----	SAMC	960214	GENERAL TOLERANCES ± 0.20/0.008		
LTR REVISION RECORD		ECN	DR	DATE			
REVISE ONLY ON CAD SYSTEM		CHK	CHK	DATE	DRAWN BY SAM.C		
					CHK'D BY		
					SCALE 2 : 1		
					TITLE : 4.20MM W-T-B, HIGH TEMP. VERTICAL HEADER. (WITHOUT MOUNTING FLANGES)		

DO NOT SCALE DRAWING

▽

F  
E  
D  
C  
B  
A

DWG. NO. SD 87427-\*\*\*4\*

CAD FILE S8742742.DGN

▽

DO NOT SCALE DRAWING

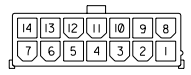

CKT.SIZE 14

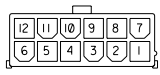

CKT.SIZE 12

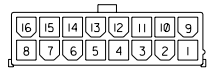

CKT.SIZE 16

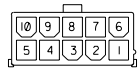

CKT.SIZE 10

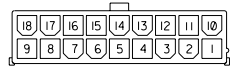

CKT.SIZE 18

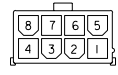

CKT.SIZE 8

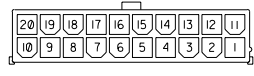

CKT.SIZE 20



CKT.SIZE 6

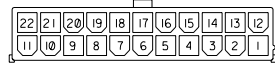

CKT.SIZE 22



CKT.SIZE 4

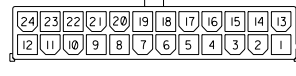

CKT.SIZE 24



CKT.SIZE 2

51.60±0.55	46.20	87427-244*	24
47.40±0.55	42.00	87427-224*	22
43.20±0.50	37.80	87427-204*	20
39.00±0.45	33.60	87427-184*	18
34.80±0.35	29.40	87427-164*	16
30.60±0.30	25.20	87427-144*	14
26.40±0.30	21.00	87427-124*	12
22.20±0.30	16.80	87427-104*	10
18.00±0.30	12.60	87427-084*	8
13.80±0.25	8.40	87427-064*	6
9.60±0.25	4.20	87427-044*	4
5.40±0.20	--	87427-024*	2
B	A	ENG. NO.	CKT. SIZE

MATERIAL :		SEE NOTES AT SHT 1		MOLEX SINGAPORE PTE LTD SHEET 2 OF 2	
FINISH :		SEE NOTES AT SHT 1		GENERAL TOLERANCES ± 0.20/.008	
C	ADDED TOL FOR DIM 'B'	I2004-0095	SS	030904	REV C
B	ADD PLATING OPTION	S70623	SAM	970630	DWG. NO.:
A	RELEASE AS PER ECN	S60393	SAM	960415	SD  87427-***4*
LTR	REVISION RECORD	ECN	DR	DATE	TITLE : 4.2MM W-T-B, HIGH TEMP. VERTICAL HEADER. (W/O MOUNTING FLANGES)
REVISE ONLY ON CAD SYSTEM		CHK	SCALE	1:1	

ALL DIMENSIONS IN MM

THIS DRAWING CONTAINS INFORMATION THAT IS PROPRIETARY TO MOLEX (S)PTE LTD AND SHOULD NOT BE USED WITHOUT WRITTEN PERMISSION