

MARKING:

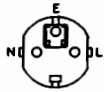

MARKING:

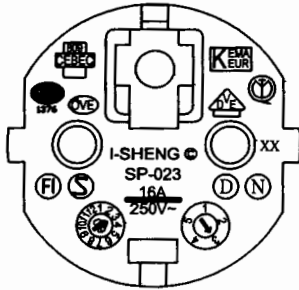
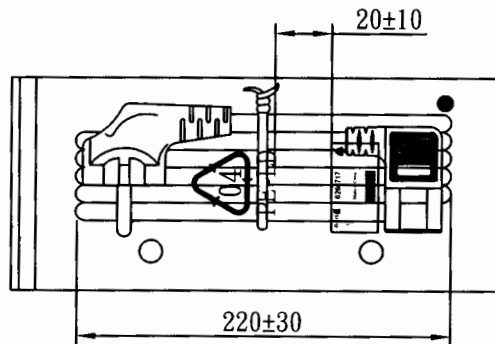
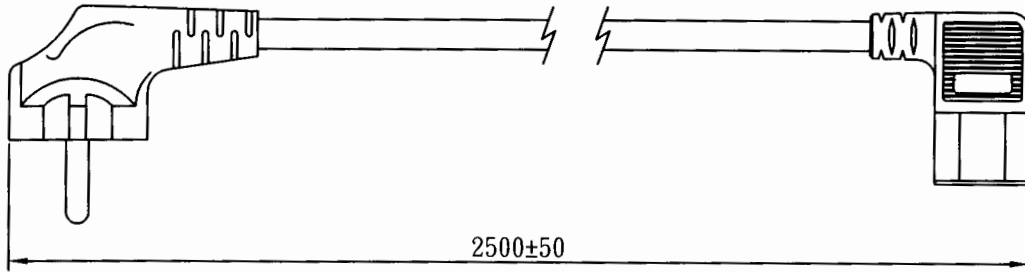
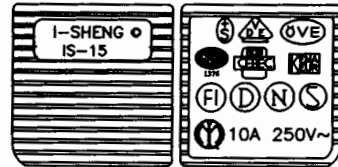
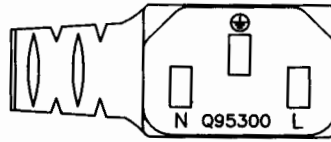

WIRING COLOR:

E: Yellow/Green
N: Blue
L: Brown

LENGED ON CORD: (205-14)

I-SHENG SGIS <VDE> KEMA-KEUR +03 +03 +03 <VDE> △CEBEC 809 Ⓢ Ⓣ Ⓝ Ⓟ
NF-USE 1346 IEMMEQU H05VV-F 3G 1.0mm² 60227 IEC 53 RVV 300/500V Ⓢ
A003083 3ASL/100 4V-75 V-75(75°C) 250/440V ORDINARY DUTY Q90033 -LF- CE



No	BOM ITEM	Q' TY	P/N
1	SP-023 INSERT(BLACK)	1 PCS	MB023012
2	PVC 45P (SA87, SP-023)	45 g	RPP0451H
3	KPR-14 TERMINAL	3 pcs	BBB14000
4	IS-14 INNER BODY	1 set	MI014000
5	PVC 45P (SA87, IS-15)	18 g	RPP0451H
6	PE TIE (WHITE, 8 inch)	1 pcs	KBW10008
7	PE BAG	1 pcs	KPR11000
8	LABLE	1 pcs	

NOTE : 1. CORD : EAN-128C
2 : SCAN CONTENT : 6266717

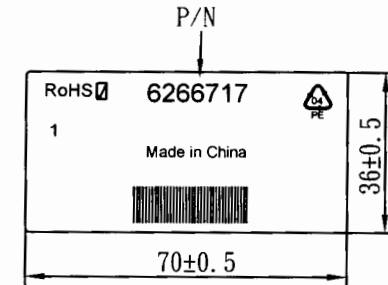

CABLE	H05VV-F 3G 1.0 DENT PRINT CT-1H (Gray)			
PLUG	SP-023 + IS-15	LENGTH	2500	UNIT mm
CLIENT	NAME	First Connectivity	N/W	0.262064 UNIT kg
	P/N	6266717	SG DWG	SR-142461-6 VER. A
	Design. by	楊望泰 9/26/24		
	Review. by			
	Approval. by	[Signature]		
Y35		6C3016	1H	250 01