

Altivar 61/71

Variable speed drives
for synchronous and asynchronous motors

EtherCAT[®] Communication Manual VW3A3326

04/2013



The information provided in this documentation contains general descriptions and/or technical characteristics of the performance of the products contained herein. This documentation is not intended as a substitute for and is not to be used for determining suitability or reliability of these products for specific user applications. It is the duty of any such user or integrator to perform the appropriate and complete risk analysis, evaluation and testing of the products with respect to the relevant specific application or use thereof. Neither Schneider Electric nor any of its affiliates or subsidiaries shall be responsible or liable for misuse of the information contained herein. If you have any suggestions for improvements or amendments or have found errors in this publication, please notify us.

No part of this document may be reproduced in any form or by any means, electronic or mechanical, including photocopying, without express written permission of Schneider Electric.

All pertinent state, regional, and local safety regulations must be observed when installing and using this product. For reasons of safety and to help ensure compliance with documented system data, only the manufacturer should perform repairs to components.

When devices are used for applications with technical safety requirements, the relevant instructions must be followed.

Failure to use Schneider Electric software or approved software with our hardware products may result in injury, harm, or improper operating results.

Failure to observe this information can result in injury or equipment damage.

© 2013 Schneider Electric. All rights reserved.

Table of Contents



	Safety Information	5
	About the Book	6
Chapter 1	ATV61/71 EtherCAT Overview	9
	Overview	10
	Software and protocols supported	11
	Communication and Services	12
	Notation rules in this manual	13
Chapter 2	Hardware Setup	15
	Hardware presentation	16
	Wiring	17
Chapter 3	Configuration	19
	ESI file (EtherCAT Slave Information)	20
	Configuring PDO (communication scanner)	21
	Configuring the Control Channels	22
	Configuring Monitor Parameters	23
	Configuring Communication Interruption Management	24
Chapter 4	Example with TwinCAT®	25
	Example: Altivar 61/71 with TwinCAT® "PLC - Configuration"	26
Chapter 5	Diagnostics and monitoring	37
	LED Indicators	38
	Communication Diagnostics	40
	Control-Signal Diagnostics	42
Chapter 6	Profiles	45
	Definition of a Profile	46
	Functional Profiles Supported by the Altivar 61/71	47
Chapter 7	Detailed Description of Services	49
	EtherCAT State Machine (ESM)	50
	Emergency Object (EMCY)	52
Chapter 8	Object Dictionary	55
	Introduction	56
	Communication Profile Area	57
	RPDO: Receive PDO	57
	TPDO: Transmit PDO	57
	Sync Manager	58
	Manufacturer Specific Area	58
	Application Profile Area	58
Chapter 9	Glossary	59

Safety Information

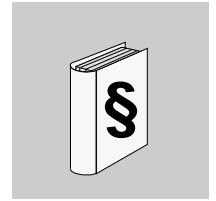

Important Information

NOTICE

Read these instructions carefully, and look at the equipment to become familiar with the device before trying to install, operate, or maintain it. The following special messages may appear throughout this documentation or on the equipment to warn of potential hazards or to call attention to information that clarifies or simplifies a procedure.



The addition of this symbol to a Danger or Warning safety label indicates that an electrical hazard exists, which will result in personal injury if the instructions are not followed.



This is the safety alert symbol. It is used to alert you to potential personal injury hazards. Obey all safety messages that follow this symbol to avoid possible injury or death.

DANGER

DANGER indicates an imminently hazardous situation, which, if not avoided, **will result** in death or serious injury.

WARNING

WARNING indicates a potentially hazardous situation, which, if not avoided, **can result** in death, serious injury or equipment damage.

CAUTION

CAUTION indicates a potentially hazardous situation, which, if not avoided, **can result** in injury or equipment damage.

NOTICE

NOTICE is used to address practices not related to physical injury.

PLEASE NOTE

The word "drive" as used in this manual refers to the controller portion of the adjustable speed drive as defined by NEC.

Electrical equipment should be installed, operated, serviced, and maintained only by qualified personnel. No responsibility is assumed by Schneider Electric for any consequences arising out of the use of this product.

© 2012 Schneider Electric. All Rights Reserved.

About the Book

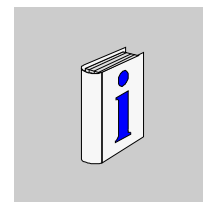

Document Scope

The purpose of this document is to:

- show you how to install the EtherCAT module on your Altivar 61/71,
- show you how to configure the Altivar 61/71 to use EtherCAT fieldbus.

NOTE: Read and understand this document and all related documents (see below) before installing, operating, or maintaining your ATV61/71.

Validity Note

This documentation is valid for the Altivar 61/71 EtherCAT fieldbus.

Related Documents

Title of Documentation	Reference Number
ATV71 Installation manual	1755843
ATV61 Programming manual	1760649
ATV71 Programming manual	1755855
ATV71 Communication parameters manual	1755861
ATV61/71 CANopen manual	1755865
ATV71 integrated Modbus	1755863
ATV71 Modbus/Uni-Telway card - Modbus protocol	1755875
ATV71 Modbus/Uni-Telway card - Uni-Telway protocol	1755867
ATV71 Modbus Plus	1755869
ATV61/71 Modbus TCP/IP - Ethernet manual	1755879
ATV61 71 Modbus TCP/IP - Daisy Chain Ethernet manual	AAV69931
ATV71 DeviceNet	1755877
ATV61 71 CC-Link manual	AAV49429
ATV61/71 Ethernet IP	AAV68822
ATV61/71 INTERBUS	1755871
ATV61/71 Profibus DP	1755873
ATV61/71 Profibus DPv1	AAV52935

You can download the latest versions of these technical publications and other technical information from www.schneider-electric.com.

Product related information

⚠ DANGER

UNINTENDED EQUIPMENT OPERATION

- Read and understand this manual before installing or operating the drive.
- Any changes made to the parameter settings must be performed by qualified personnel.

Failure to follow these instructions will result in death or serious injury.

⚠ ⚠ DANGER

HAZARD OF ELECTRIC SHOCK, EXPLOSION OR ARC FLASH

- Only appropriately trained persons who are familiar with and understand the contents of this manual and all other pertinent product documentation and who have received safety training to recognize and avoid hazards involved are authorized to work on and with this product system. Installation, adjustment, repair and maintenance must be performed by qualified personnel.
- The system integrator is responsible for compliance with all local and national electrical code requirements as well as all other applicable regulations with respect to grounding of all equipment.
- Many components of the product, including the printed circuit boards, operate with mains voltage. Do not touch. Use only electrically insulated tools.
- Do not touch unshielded components or terminals with voltage present.
- Motors can generate voltage when the shaft is rotated. Prior to performing any type of work on the product system, block the motor shaft to prevent rotation.
- AC voltage can couple voltage to unused conductors in the motor cable. Insulate both ends of unused conductors of the motor cable.
- Do not short across the DC bus terminals or the DC bus capacitors or the braking resistor terminals.
- Before performing work on the product system:
 - Disconnect all power, including external control power that may be present.
 - Place a "Do Not Turn On" label on all power switches.
 - Lock all power switches in the open position.
 - Wait 15 minutes to allow the DC bus capacitors to discharge. The DC bus LED is not an indicator of the absence of DC bus voltage that can exceed 800 Vdc. Measure the voltage on the DC bus between the DC bus terminals using a properly rated voltmeter to verify that the voltage is <42 Vdc.
 - If the DC bus capacitors do not discharge properly, contact your local Schneider Electric representative.
- Install and close all covers before applying voltage.

Failure to follow these instructions will result in death or serious injury.

⚠ WARNING

DAMAGE DRIVE EQUIPMENT

Do not operate or install any drive or drive accessory that appears damaged.

Failure to follow these instructions can result in death, serious injury, or equipment damage.

⚠ WARNING

LOSS OF CONTROL

- The designer of any control scheme must
 - consider the potential failure modes of control paths and, for certain critical control functions,
 - provide a means to achieve a safe state during and after a path failure.
 Examples of critical control functions are emergency stop and overtravel stop.
- Separate or redundant control paths must be provided for critical control functions.
- System control paths may include communication links. Consideration must be given to the implications of unanticipated transmission delays or failures of the link.⁽¹⁾

Failure to follow these instructions can result in death, serious injury, or equipment damage.

(1) For additional information, refer to NEMA ICS 1.1 (latest edition), "Safety Guidelines for the Application, Installation, and Maintenance of Solid State Control" and to NEMA ICS 7.1 (latest edition), "Safety Standards for Construction and Guide for Selection, Installation and Operation of Adjustable-Speed Drive Systems."

ATV61/71 EtherCAT Overview



1

What's in this Chapter?

This chapter contains the following topics:

Topic	Page
Overview	10
Software and protocols supported	11
Communication and Services	12
Notation rules in this manual	13

Overview

The VW3A3326 communication card enables the integration of an Altivar 61/71 variable speed drive into an EtherCAT network.

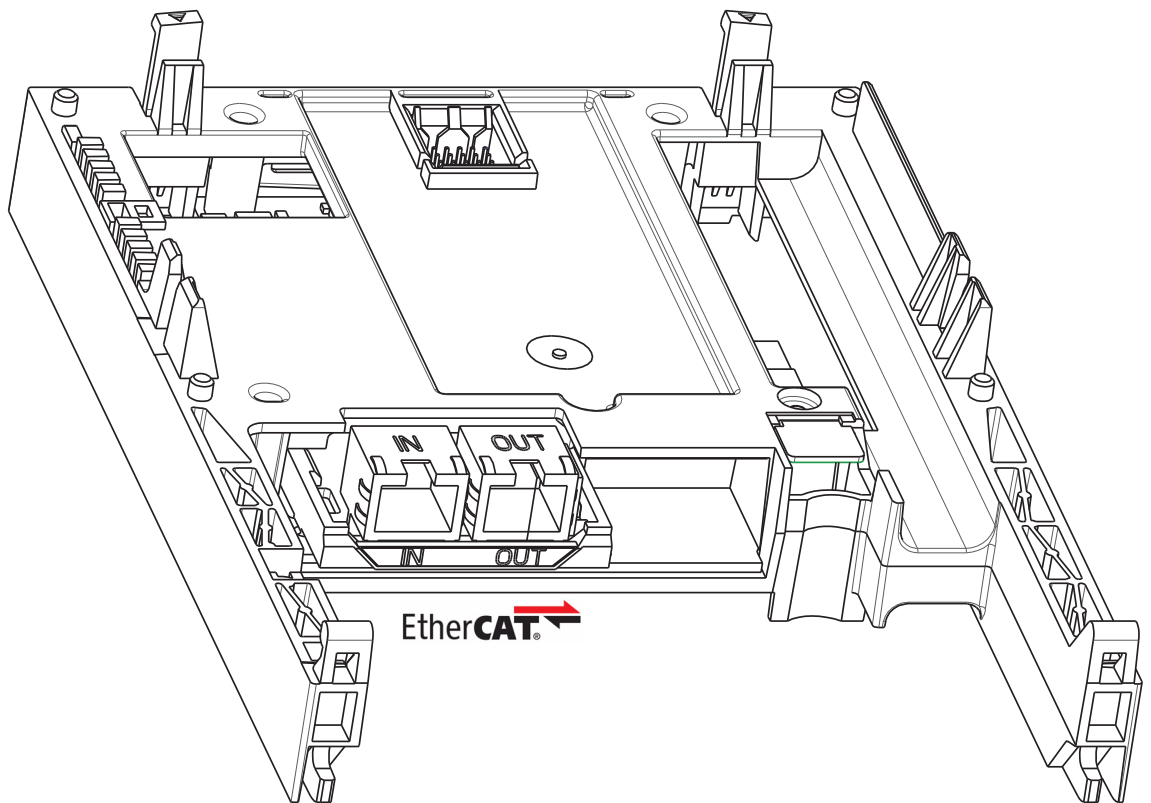

Software and protocols supported

ATV61/71 compatibility

The VW3A3326 EtherCAT card is compliant with ATV71 minimum version 5.7 and ATV61 minimum version 5.8.

ATV61/71 Profile with EtherCAT®

EtherCAT® is a registered trademark and patented technology licensed by Beckhoff Automation GmbH, Germany. The ATV61/71 supports CANopen CiA®402 V3 drive profile, using CoE (CAN application layer Over EtherCAT).

BECKHOFF® software

The ATV61/71 communication card is compliant with BECKHOFF software TwinCAT® V2.x with CodeSys V2.

Further reading

Recommended literature for further reading
EtherCAT Technology Group (ETG), see www.ethercat.org

Communication and Services

Cyclical Communication: PDO

- PDO is intended for use with the communication scanner according to CiA402.
- PDO overview

CMD value	LFRD value	NC3	NC4	NC5	NC6	NC7	NC8	= RPDO
ETA value	RFRD value	NM3	NM4	NM5	NM6	NM7	NM8	= TPDO

The configuration means are:

- EtherCAT configuration tool, then the configuration is downloaded by the master,
- SoMove or SoMachine: DTM ATV61/71.

Acyclic Services: SDO

The ATV61/71 manages a SDO server (Service Data Object). SDO telegrams are used for configuration and adjustment, they are characterized by two identifiers:

- One for requests (telegrams sent from the PLC to the Altivar)
- One for responses (telegrams sent back to the PLC by the Altivar)

Other Supported Services

Assignment by default of address-based identifiers.

- EtherCAT state machine commands
- Emergency (EMCY)

ESI file (EtherCAT Slave Information)

Download the ESI file in XML format for the ATV61/71 on www.schneider-electric.com.

Notation rules in this manual

Drive Terminal Displays

The graphic display terminal (to be ordered separately - reference VW3A1101) menus are shown in square brackets.

Example: **[COMMUNICATION]**

The integrated 7-segment display terminal menus are shown in round brackets.

Example: **(C D Π-)**

Parameter names are displayed on the graphic display terminal in square brackets.

Example: **[Fallback speed]**

Parameter codes are displayed on the integrated 7-segment display terminal in round brackets.

Example: **(L F F)**

Formats

In this manual, hexadecimal values are written as follows: 16#

Hardware Setup



2

What's in this Chapter?

This chapter contains the following topics:

Topic	Page
Hardware presentation	16
Wiring	17

Hardware presentation

Receipt

- Check that the card catalog number marked on the label is the same as that on the delivery note corresponding to the purchase order.
- Remove the communication module from its packaging and check that it has not been damaged in transit.

⚠ ⚠ DANGER

HAZARD OF ELECTRIC SHOCK, EXPLOSION OR ARC FLASH

Read and understand the precautions in the About the book section before performing the procedure in this section.

Failure to follow these instructions will result in death or serious injury.

Presentation

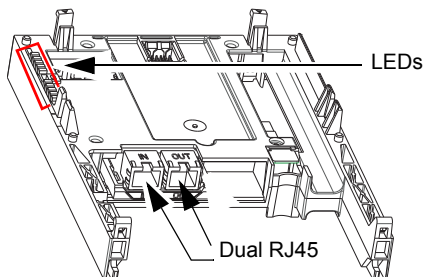

Installation

First remove the control front panel.

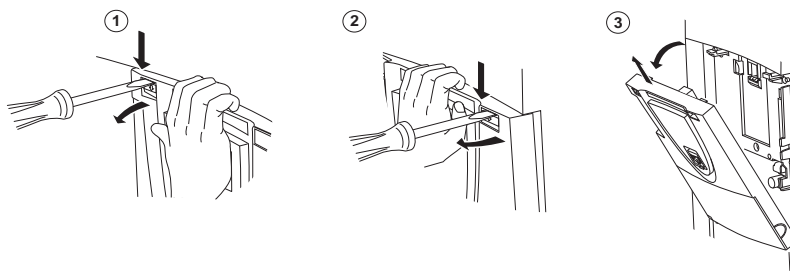

NOTICE

RISK OF DAMAGE TO THE CONNECTOR

Ensure good positioning of the option card on the clasps to avoid damage to the connector.

Failure to follow these instructions can result in equipment damage.

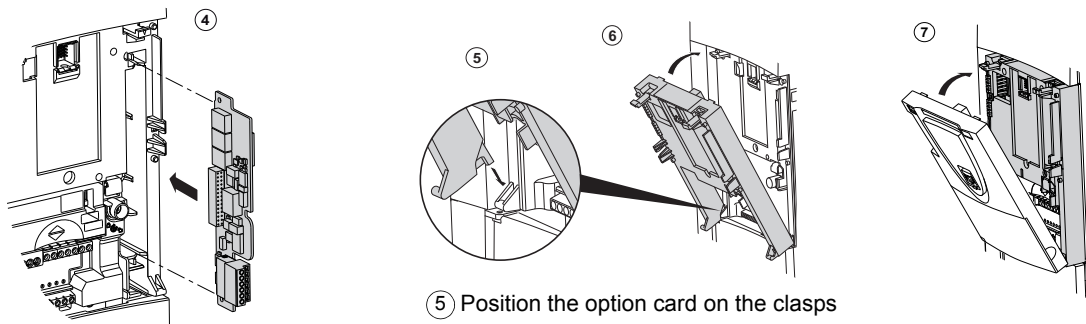

④ Install encoder interface card (if used)

⑤ Position the option card on the clasps

⑥ Then pivot it until it clicks into place

⑦ Replace the control front panel over the option card (same procedure as for installing the option card, see ⑤ and ⑥)

Wiring

The VW3A3326 option card is equipped with 2 RJ45 female sockets for the Ethernet connection.

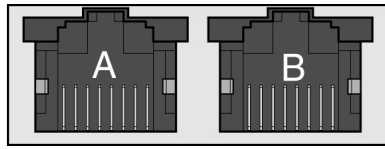

Port	Fieldbus
A	EtherCAT IN
B	EtherCAT OUT

8 7 6 5 4 3 2 1 8 7 6 5 4 3 2 1

Topology EtherCAT

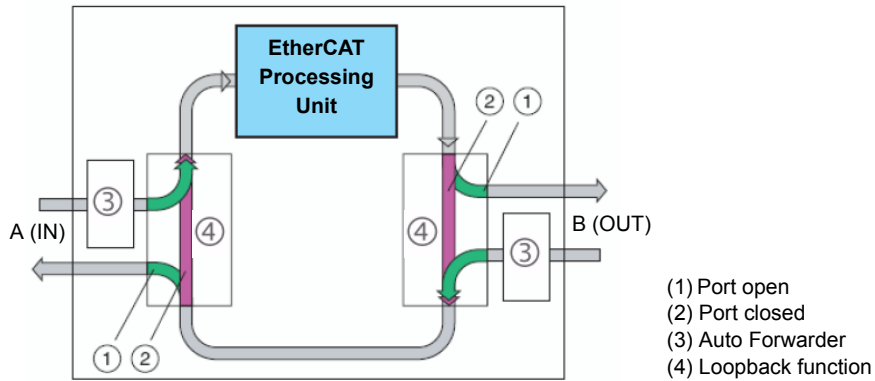

Cable specifications

- Minimum Cat 5e,
- Use equipotential bonding conductors,
- Connector RJ45, no crossover cable
- Shield: both ends grounded
- Twisted pair cable
- Cable: 8 x 0.25 mm² (8 x AWG 22)
- Use pre-assembled cables to reduce the wiring mistakes,
- Verify that wiring, cables and connected interfaces meet the PELV requirements.
- Maximum cable length between devices = 100 m (328 ft)

The following table describes the pin out of each RJ45:

Pin	Signal	Meaning
1	Tx+	Ethernet transmit line +
2	Tx-	Ethernet transmit line -
3	Rx+	Ethernet receive line +
4	-	-
5	-	-
6	Rx-	Ethernet receive line -
7	-	-
8	-	-

Note: External control power supply can be used to maintain the communication active even if the drive is not powered.

Configuration

3

What's in this Chapter?

This chapter contains the following topics:

Topic	Page
ESI file (EtherCAT Slave Information)	20
Configuring the Communication Parameters	20
Configuring Monitor Parameters	23
Configuring Communication Interruption Management	24

ESI file (EtherCAT Slave Information)

Download the ESI file in XML format for the ATV61/71 on www.schneider-electric.com.

The ESI file must be integrated into the system of the master controller.

Configuring the Communication Parameters

The parameters described are accessible with the ATV61/71 Integrated display terminal, the Graphic display terminal option or with SoMove software. The parameters are visible only if an EtherCAT card is plugged in the drive

The configuration of the EtherCAT communication functions is reachable with the drive menu **[1.9 - COMMUNICATION] (C D P -)**.

NOTE: the configuration can only be modified when the motor is stopped and the drive stopped.

Communication Parameters

Parameter description	Range or listed values (1)	Default value	Access	Parameter address
[EthCat slave status] (E C S S) EtherCAT slave status.	1: [Init] (I n I t) Initialization 2: [PreOp] (P r O p) Pre-operational 3: [Boot] (b o o t) Bootstrap 4: [SafeOp] (S F O p) Safe operational In [SafeOp] mode, inputs are updated in PDOs, outputs are not valid. 8: [Op] (O p) Operational In [Op] mode, inputs and outputs are valid		R	6690
[EthCat 2nd addr] (E C S A) EtherCAT 2 nd address	0 to 65535 Address changeable from drive or from master via the 2 nd address dialog.	0	R/W	6691 UINT
[EthCat addr] (E C A A) EtherCAT Actual Address Changed settings become active immediately.	0 to 65535	0	R	6692 UINT

Configuring PDO (communication scanner)

PDOs are configured by configuring the communication scanner.

The 8 periodic output variables are assigned by means of parameters nCA1 to nCA8. They are configured using the graphic display terminal via the **[1.9 - COMMUNICATION] (C D P -)** menu and **[COM. SCANNER OUTPUT] (D C S -)** submenu.

Note: **[COM. SCANNER OUTPUT] (D C S -)** submenu defines the data (parameters nCA1 to nCA8) from the PLC to the drive.

An nCA● parameter with a value of zero does not designate any parameter in the drive. These 8 words are described in the table below:

Parameter name	PDOs variable	Default assignment
[Scan. Out1 address] (n C A 1)	RPDO1	Command word (CMD)
[Scan. Out2 address] (n C A 2)	RPDO2	Speed target (LFRD)
[Scan. Out3 address] (n C A 3)	RPDO3	Not used
[Scan. Out4 address] (n C A 4)	RPDO4	Not used
[Scan. Out5 address] (n C A 5)	RPDO5	Not used
[Scan. Out6 address] (n C A 6)	RPDO6	Not used
[Scan. Out7 address] (n C A 7)	RPDO7	Not used
[Scan. Out8 address] (n C A 8)	RPDO8	Not used

The 8 periodic input variables are assigned by means of parameters nMA1 to nMA8. They are configured using the graphic display terminal via the **[1.9 - COMMUNICATION] (C D P -)** menu and **[COM. SCANNER INPUT] (I C S -)** submenu.

Note: **[COM. SCANNER INPUT] (I C S -)** submenu defines the data (parameters nMA1 to nMA8) from the drive to the PLC.

An nMA● parameter with a value of zero does not designate any parameter in the drive. These 8 words are described in the table below:

Parameter name	PDOs variable	Default assignment
[Scan. In1 address] (n M A 1)	TPDO1	Status word (ETA)
[Scan. In2 address] (n M A 2)	TPDO2	Output speed (RFRD)
[Scan. In3 address] (n M A 3)	TPDO3	Not used
[Scan. In4 address] (n M A 4)	TPDO4	Not used
[Scan. In5 address] (n M A 5)	TPDO5	Not used
[Scan. In6 address] (n M A 6)	TPDO6	Not used
[Scan. In7 address] (n M A 7)	TPDO7	Not used
[Scan. In8 address] (n M A 8)	TPDO8	Not used

Example of configuring PDOs via the graphic display terminal:

RDY	NET	+0.00Hz	0A
COM. SCANNER INPUT <input type="checkbox"/>			
Scan. In1 address	:		3201
Scan. In2 address	:		8604
Scan. In3 address	:		0
Scan. In4 address	:		0
Scan. In5 address	:		0
Code		Quick	<input checked="" type="checkbox"/>
Scan. In6 address	:		0
Scan. In7 address	:		0
Scan. In8 address	:		0

RDY	NET	+0.00Hz	0A
COM. SCANNER OUTPUT <input type="checkbox"/>			
Scan. Out1 address	:		8501
Scan. Out2 address	:		8602
Scan. Out3 address	:		0
Scan. Out4 address	:		0
Scan. Out5 address	:		0
Code		Quick	<input checked="" type="checkbox"/>
Scan. Out6 address	:		0
Scan. Out7 address	:		0
Scan. Out8 address	:		0

Note:

Modifications to parameters nMA1 ... nMA8 or nCA1 ... nCA8 shall be made with the motor stopped. The master PLC program should be updated to take account of this modification.

Configuring the Control Channels

This chapter explains through 2 examples how to configure the drive for operation from communication network:

- I/O Mode - a simple command Word (based on Forward, reverse and reset binary commands).
- Combined Mode (with native profile CiA402) - Both reference and command word come from the communication network.

PDOs Configuration

See “Detailed Description of Services” on page 49.

Configuration of the Drive for Operation in I/O Profile

To illustrate the I/O Profile, we will describe a quick example, which can be of course extended with additional features. The Command word is made of Run forward (bit 0 of CMD), run reverse (bit 1 of CMD), and a detected fault reset (bit 7 of CMD).

[INPUTS / OUTPUTS CFG] /

[Forward] is always assigned to CMD bit 0

[INPUTS / OUTPUTS CFG] /

[Reverse assign.] is assigned to CMD bit 1

[FAULT MANAGEMENT] / [FAULT

RESET] / [Fault reset] is assigned to CMD bit 7

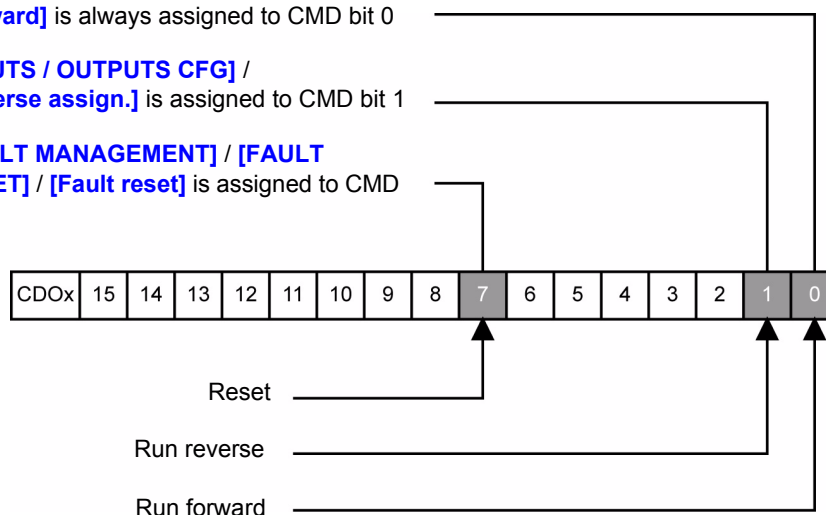

The settings will be the following in the Command Menu **[Command] (C E L -)**:

Menu	Parameter	Value
<i>dr I - > C E L -</i>	[Ref.1 channel] (F r I)	[Com. card] (n E E)
	[RV Inhibition] (r I n)	Default
	[Stop Key priority] (P S E)	Default
	[Profile] (C H C F)	[I/O profile] (I D)
	[Cmd switching] (C C S)	Default
	[Cmd channel 1] (C d I)	[Com. card] (n E E)

The bits of the command word can now be configured.

In the **[INPUTS / OUTPUTS CFG] (I _ D -)** Menu, configure:

Menu	Parameter	Value
<i>dr I - > I _ D -</i>	[Reverse assign.] (r r S)	[Cd01] (C d D I)

In the **[FAULT MANAGEMENT] (F L E -)** menu, **[FAULT RESET] (r S E -)** submenu, configure:

Menu	Parameter	Value
<i>dr I - > F L E - > r S E -</i>	[Fault reset] (r S F)	[Cd07] (C d D 7)

Configuration of the Drive for Operation With CiA402 Profile in Combined Mode

This chapter describes how to configure the settings of the drive if it is controlled in CiA402 Mode. The example focuses on the Not separate mode (Combined). Additional modes such separate Mode are detailed in the ATV61/71 Programming manual.

In the Command Menu **[Command] (C E L -)**:

Menu	Parameter	Value
<i>dr I - > C E L -</i>	[Ref.1 channel] (F r I)	[Com. card] (n E E)
	[Profile] (C H C F)	[Not separ.] (S I n) CiA402 Combined mode, (factory setting)

Configuring Monitor Parameters

It is possible to select up to 4 parameters to display their values in the **[1.2 MONITORING]** menu on the graphic display terminal (to be ordered separately - reference VW3A1101).

The selection is made via the **[6 MONITORING CONFIG.]** --> **[COM. MAP CONFIG.]** submenu.

Each parameter in the range **[Word 1 add. select.] ... [Word 4 add. select.]** can be used to select the parameter logic address. An address at zero is used to disable the function.

Example

In the example given here, the monitored words are:

- Parameter 1 = **[Motor current] (L C r)**: logic address 3204, signed decimal format.
- Parameter 2 = **[Motor torque] (D E r)**: logic address 3205, signed decimal format.
- Parameter 3 = **[Last fault occurred] (L F E)**: logic address 7121, hexadecimal format.
- Disabled parameter: 0; default format: Hexadecimal format

RDY	CAN	+0.00Hz	0A
COM. MAP CONFIG.			
Address 1 select	:		3204
FORMAT 1	:		Signed
Address 2 select	:		3205
FORMAT 2	:		Signed
Address 3 select	:		7121
Code		Quick	▼
FORMAT 3	:		Hex
Address 4 select	:		0
FORMAT 4	:		Hex

One of the three display formats below can be assigned to each monitored word:

Format	Range	Terminal display
Hexadecimal	0000 ... FFFF	[Hex]
Signed decimal	-32 767 ... 32 767	[Signed]
Unsigned decimal	0 ... 65 535	[Unsigned]

NOTE: If a monitored parameter:

- has been assigned to an unknown address,
- has been assigned to a protected parameter,
- has not been assigned,

the value displayed in the **[COMMUNICATION MAP]** screen is: "••••" (see "Diagnostics and monitoring" on page 37).

Configuring Communication Interruption Management

▲ WARNING

LOSS OF CONTROL

If Network fault management **[Network fault mgt] (C L L)** is set to **[Ignore] (n D)**, communication control will be inhibited.

For safety reasons, inhibiting the communication interruption detection should be restricted to the debug phase or to special applications.

Failure to follow these instructions can result in death, serious injury, or equipment damage.

The response of the drive in the event of a communication interruption can be configured.

With the graphic display terminal or the integrated display terminal, select the drive menu:

[1.8 FAULT MANAGEMENT] (F L E -) --> **[COM. FAULT MANAGEMENT] (C L L -)**,
via the **[Network fault mgt] (C L L)** parameter.

RDY	nEt	+0.00Hz	0A
COM. FAULT MANAGEMENT			<input type="checkbox"/>
Network fault mgt	:	Freewheel	
CANopen fault mgt	:	Freewheel	
Modbus fault mgt	:	Freewheel	
Code		Quick	<input type="checkbox"/>

The values of the **[Network fault mgt] (C L L)** parameter, which trigger a drive detected fault **[Com. network] (C n F)**, are:

Value	Meaning
[Freewheel] (Y E S)	Freewheel stop (factory setting)
[Ramp stop] (r n P)	Stop on ramp
[Fast stop] (F S E)	Fast stop
[DC injection] (d C I)	DC injection stop. This type of stop cannot be used with certain other functions. See the Programming manual.

The values of the **[Network fault mgt] (C L L)** parameter, which do not trigger a drive detected fault, are:

Value	Meaning
[Ignore] (n D)	Detected fault ignored
[Per STT] (S E E)	Stop according to configuration of [Type of stop] (S E E) , see the Programming manual for more details.
[fallback speed] (L F F)	Change to fallback speed, maintained as long as the detected fault persists and the run command has not been removed
[Spd maint.] (r L S)	The drive maintains the speed at the time the detected fault occurred, as long as the detected fault persists and the run command has not been removed

The fallback speed can be configured in the **[FAULT MANAGEMENT] (F L E -)** / **[FALLBACK SPEED] (L F F -)** menu using the **[Fallback speed] (L F F)** parameter.

Example with TwinCAT®



4

What's in this Chapter?

This chapter contains the following topics:

Topic	Page
Example: Altivar 61/71 with TwinCAT® "PLC - Configuration"	26

Example: Altivar 61/71 with TwinCAT® "PLC - Configuration"

1. Hardware

Connect your computer and the ATV61/71 EtherCAT option with a standard Cat 5e minimum cable (2 x RJ45, shielded twisted pair cable)

2. TwinCAT® software installation

Install the TwinCAT® software. Example realized with TwinCAT® software version 2.11.

Note: The screenshots or procedure in this example may change with a new TwinCAT® software version.

3. ESI file (EtherCAT Slave Information)

Download the ESI file in XML format (Schneider_Electric_ATV71_Vxxx.xml) for the ATV61/71 on www.schneider-electric.com.

Copy this XML file on your computer in C:\TwinCAT\Io\EtherCAT.

Integrate the ESI file into the system of the master controller.

4. Altivar 61/71 configuration

Realize the configuration of the Drive for Operation With CiA402 Profile in Combined Mode.

Set [Ref.1 channel] (*F r I*) to [Com. card] (*n E k*),

Set [Profile] (*C H C F*) to [Not separ.] (*S I N*) CiA402 Combined mode, (factory setting).

5. System Manager: Declare your computer on Ethernet network

Start TwinCAT® system-manager®  TwinCAT System Manager

Select Option --> "Show Real Time Ethernet Compatible devices"

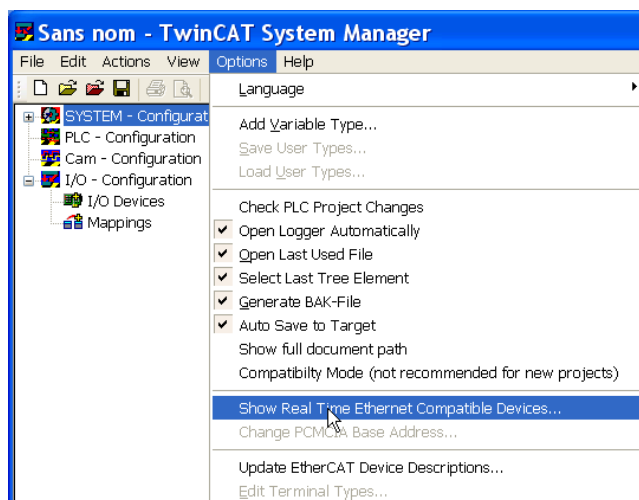

① Select your Computer Ethernet board, and "Install".

② Enable it.

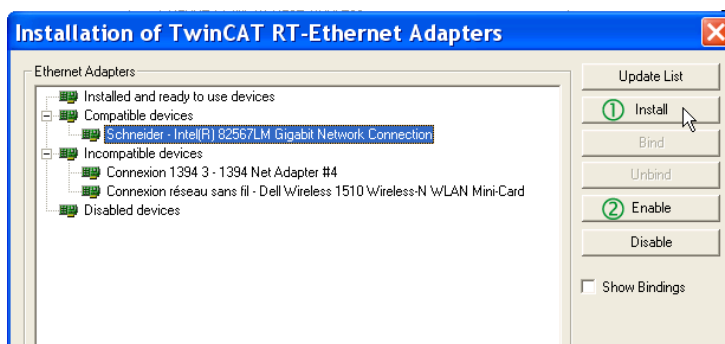

6. System Manager: Install the master

In this example we use the computer to run TwinCAT® and PLC runtime as Master.

- ① Select “Choose Target”
- ② Select “Search (Ethernet)”

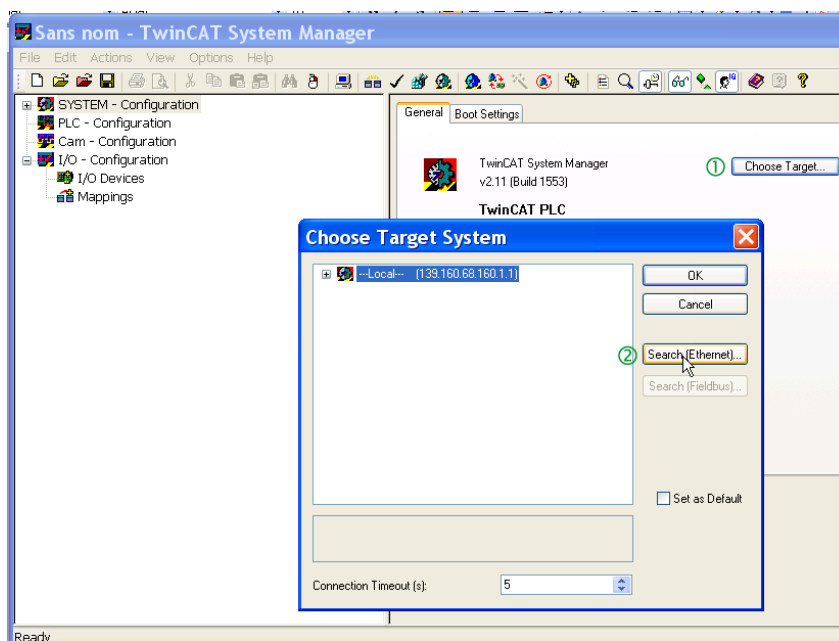

- ③ Start the “Broadcast Search”
- ④ Select your Master in the Host Name list (your computer in this example)

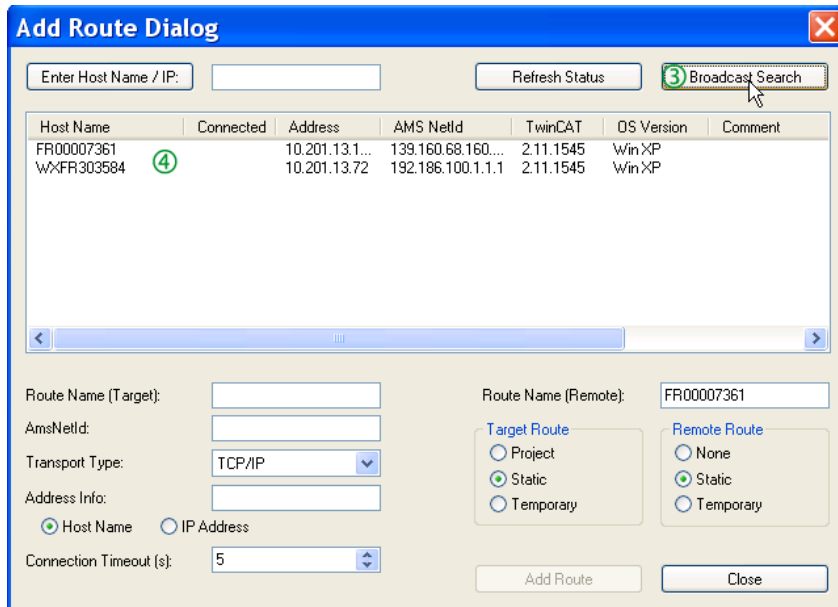

⑤ Check that you are in “config mode”

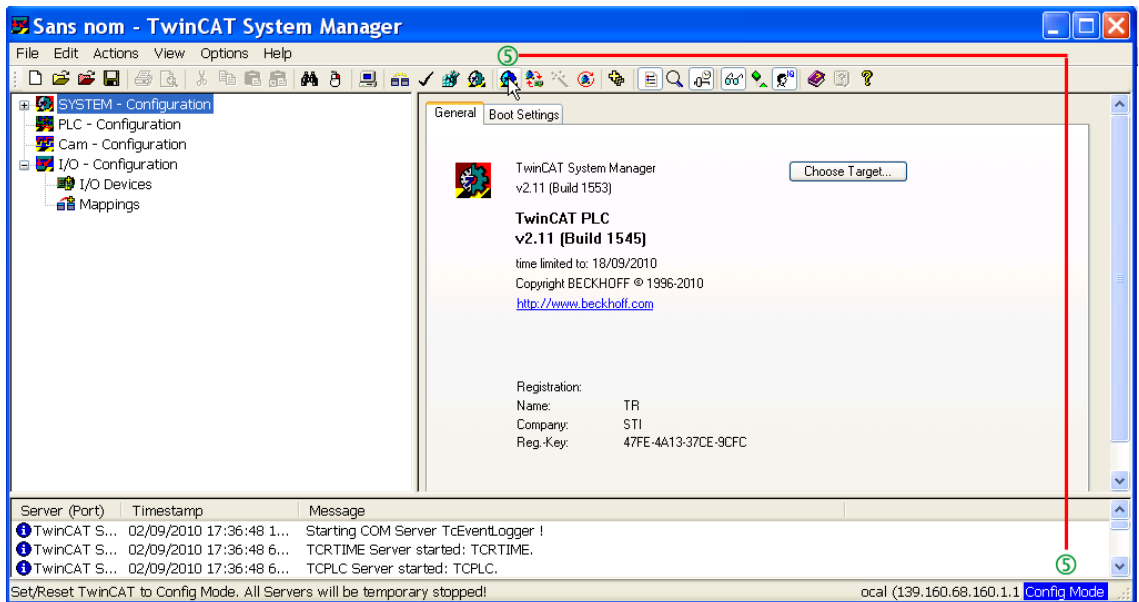

7. System Manager - Install the slave: Altivar 61/71 in "PLC – Configuration"

1. TwinCAT System Manager - Main window showing the I/O Configuration tree. The 'Scan Devices...' option is selected under 'I/O Devices'.

2. TwinCAT System Manager - Hint dialog: HINT: Not all types of devices can be found automatically. OK button is highlighted.

3. 1 new I/O devices found - Dialog showing 'Device 1 (EtherCAT) [Schneider (Intel(R) 82567LM Gigabit Network Connection - Te...]' is found. OK button is highlighted.

4. TwinCAT System Manager - Scan for boxes dialog. Yes button is highlighted.

5. TwinCAT System Manager - Activate Free Run dialog. Yes button is highlighted. **ATV71 created**

6. PC_ATV32_ATV71_LXM32Freerun1ms.tsm - TwinCAT System Manager - Main window showing the configuration tree. The 'Device 1 (EtherCAT)' is expanded, showing 'Box 1 (ATV EtherCAT)'.

8. PLC – Control: initialization

Start TwinCAT PLC control® software TwinCAT PLC Control

File -> new

Choose Target System Type

PC or CX (x86) CX (ARM) OK Cancel

BC via AMS

BC serial

BCx50 or BX via AMS

BCx50 or BX via serial

New POU

Name of the new POU: MAIN OK Cancel

Type of POU

Program Function Block Function

Return Type: BOOL

Language of the POU

IL LD FBD SFC ST ST: Structured language CFC

Select: Resources -> Library Manager

Add EtherCAT libraries

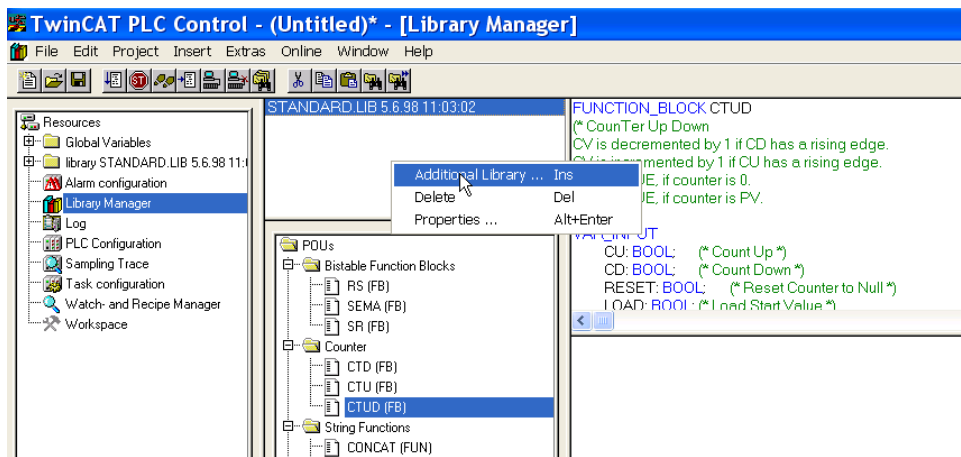

Add TcEtherCAT.lib

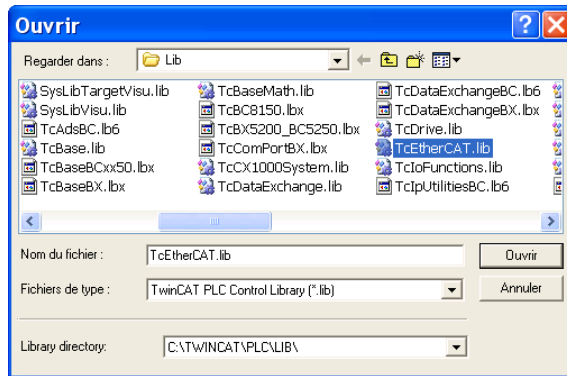

EtherCAT libraries are added:

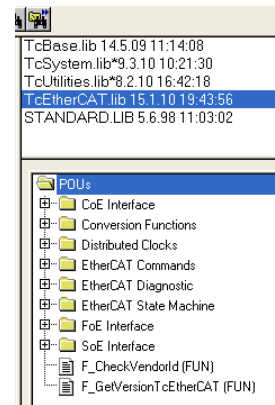

9. PLC - Control: Declare the variables

Select Global_Variables

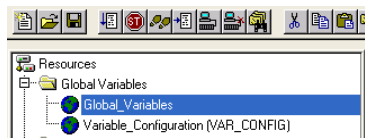

Create the Master Global_Variables for ATV61/71 as below. Copy/paste the variables:

VAR_GLOBAL

```

ATV71_State AT %I*:WORD;
PLC_state AT %I*:UINT;
ATV71_TPDO_Input1_Status_Word AT %I*:WORD;
ATV71_TPDO_Input2_Control_Effort AT %I*:WORD;
ATV71_TPDO_Input3 AT %I*:WORD;
ATV71_TPDO_Input4 AT %I*:WORD;
ATV71_TPDO_Input5 AT %I*:WORD;
ATV71_TPDO_Input6 AT %I*:WORD;
ATV71_TPDO_Input7 AT %I*:WORD;
ATV71_TPDO_Input8 AT %I*:WORD;
ATV71_RPDO_Output1_Control_Word AT %Q*:WORD;
ATV71_RPDO_Output2_Target_Velocity AT %Q*:WORD;
ATV71_RPDO_Output3 AT %Q*:WORD;
ATV71_RPDO_Output4 AT %Q*:WORD;
ATV71_RPDO_Output5 AT %Q*:WORD;
ATV71_RPDO_Output6 AT %Q*:WORD;
ATV71_RPDO_Output7 AT %Q*:WORD;
ATV71_RPDO_Output8 AT %Q*:WORD;

```

END_VAR

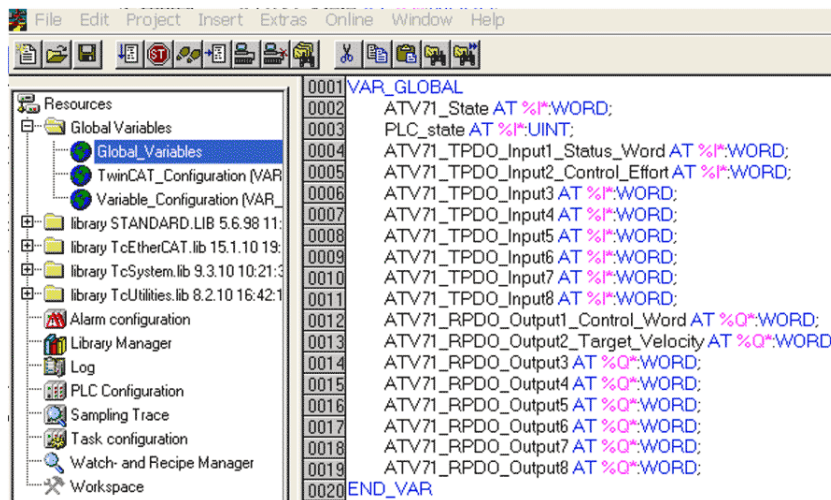

Reminder:

- RPDO (Receive PDO), containing 8 input words of the communication scanner NCA1 to NCA8.
- TPDO (Transmit PDO), containing 8 output words of the communication scanner NMA1 to NMA8.

Add 1 instruction minimum in POU's before rebuild;

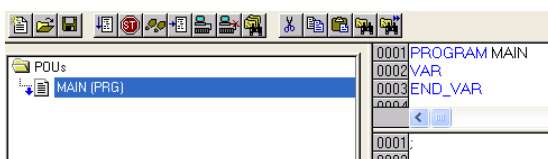

- Select: Project -> Rebuild All
- Check the compilation result without error.
- This action creates files in: C:\TwinCAT\Plc\
As example, create: ATV71_PLC.tpy

10. System Manager - Append PLC Project

In System Manager software, realize the link between the Master and the slave. Creation of the links between "PLC - Configuration" and "I/O - Configuration"

Select "Append PLC Project...":

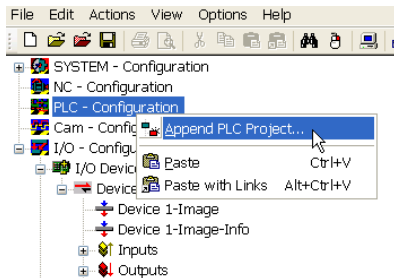

As example, select: C:\TwinCAT\Plc\ATV71_PLC.tpy

For each parameter, create the link with the ATV71 I/O listing

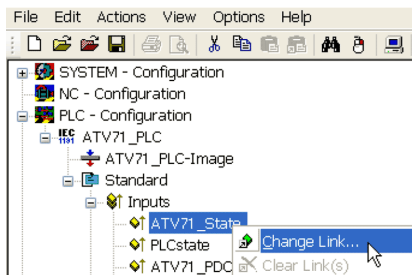

Example for "ATV71_State"

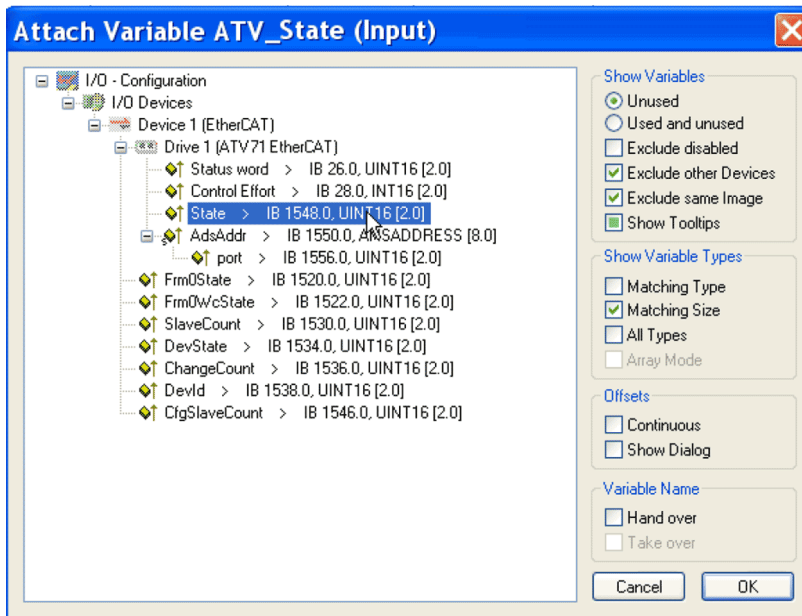

Links to create

PLC - Configuration		I/O - Configuration
Inputs	ATV71_State	State
Inputs	PLC_state	DevState (with Device1)
Inputs	ATV71_TPDO_Input1_Status_Word	Status word
Inputs	ATV71_TPDO_Input2_Control_Effort	Control effort
Inputs	ATV71_TPDO_Input3	Available for other parameter
Inputs	ATV71_TPDO_Input4	Available for other parameter
Inputs	ATV71_TPDO_Input5	Available for other parameter
Inputs	ATV71_TPDO_Input6	Available for other parameter
Inputs	ATV71_TPDO_Input7	Available for other parameter
Inputs	ATV71_TPDO_Input8	Available for other parameter
Outputs	ATV71_RPDO_Output1_Control_Word	Control word
Outputs	ATV71_RPDO_Output2_Target_Velocity	Target Velocity
Outputs	ATV71_RPDO_Output3	Available for other parameter
Outputs	ATV71_RPDO_Output4	Available for other parameter
Outputs	ATV71_RPDO_Output5	Available for other parameter
Outputs	ATV71_RPDO_Output6	Available for other parameter
Outputs	ATV71_RPDO_Output7	Available for other parameter
Outputs	ATV71_RPDO_Output8	Available for other parameter

Note: if more than 8 input or output parameters are created in TwinCAT® System Manager, the ATV61/71 will be blocked in "PreOp" state. The ATV61/71 has maximum 8 TPDO and 8 RPDO.

Select: Actions -> Generate Mappings.

11. PLC - Control: new compilation

Select: Project -> Rebuild All

This action updates the information. At this step, if the TwinCAT_Configuration (VAR_CONFIG) is not in the Global Variables, the information will not be updated, and the link will not be built.

12. System Manager: Activate configuration

Select: Actions -> Activate Configurations

13. PLC - Control: new compilation

Select: Online -> login

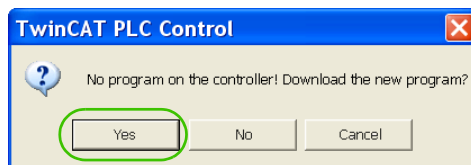

Select: Online -> Run

The PLC and the EtherCAT fieldbus are now running

In TwinCAT® PLC Control, you see the list of the variables and values:

0001	ATV71_State (%IB12) = 16#0008
0002	PLC_state (%IB16) = 16#0000
0003	ATV71_TPDO_Input1_Status_Word (%IB18) = 16#0250
0004	ATV71_TPDO_Input2_Control_Effort (%IB20) = 16#0000
0005	ATV71_TPDO_Input3 (%IB22) = 16#0000
0006	ATV71_TPDO_Input4 (%IB24) = 16#0000
0007	ATV71_TPDO_Input5 (%IB26) = 16#0000
0008	ATV71_TPDO_Input6 (%IB28) = 16#0000
0009	ATV71_TPDO_Input7 (%IB30) = 16#0000
0010	ATV71_TPDO_Input8 (%IB32) = 16#0000
0011	ATV71_RPDO_Output1_Control_Word (%QB0) = 16#0002
0012	ATV71_RPDO_Output2_Target_Velocity (%QB2) = 16#0000
0013	ATV71_RPDO_Output3 (%QB4) = 16#0000
0014	ATV71_RPDO_Output4 (%QB6) = 16#0000
0015	ATV71_RPDO_Output5 (%QB8) = 16#0000
0016	ATV71_RPDO_Output6 (%QB10) = 16#0000
0017	ATV71_RPDO_Output7 (%QB12) = 16#0000
0018	ATV71_RPDO_Output8 (%QB14) = 16#0000

14. PLC - Control: start and stop the motor

To modify the ATV61/71 state, refer to CiA402 state chart.

Example to start the motor:

- The ATV61/71 is on "switch on disabled" state and (**n 5 t**) display on ATV61/71
- Set "ATV71_RPDO_Output1_Control_Word (%QB0) = 16#0006
- The ATV71 is on "ready to switch on" state and (**r d y**) display on ATV61/71
- Set "ATV71_RPDO_Output1_Control_Word (%QB0) = 16#0007
- The ATV71 is on "switched on" state and (**r d y**) display on ATV61/71
- Set "ATV71_RPDO_Output1_Control_Word (%QB0) = 0x000F
- The ATV61/71 is on "operational Enable".state
- Set "ATV71_RPDO_Output2_Target_Velocity (%QB2) = 16#05DC
- The Motor starts, and the ATV61/71 displays (**S 0 . 0**) Hz
- Set "ATV71_RPDO_Output1_Control_Word (%QB0) = 16#0000
- The motor stops and ATV61/71 go back on "switch on disabled" state with (**n 5 t**) display

15. PLC - Control: add a library for other services

Install the library: TcEtherCAT.lib

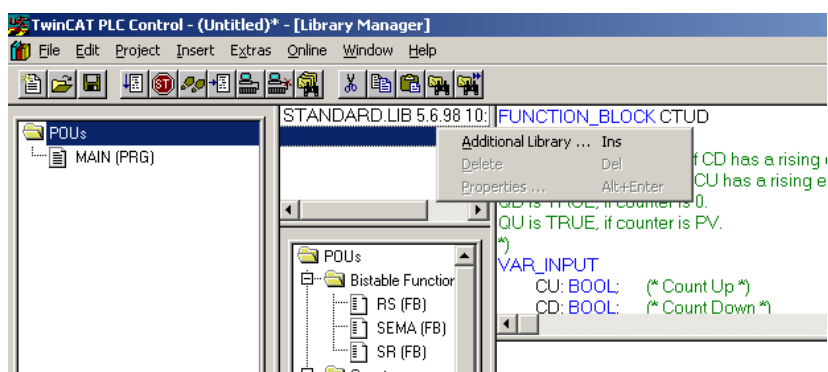

Example for exchanges with SDO

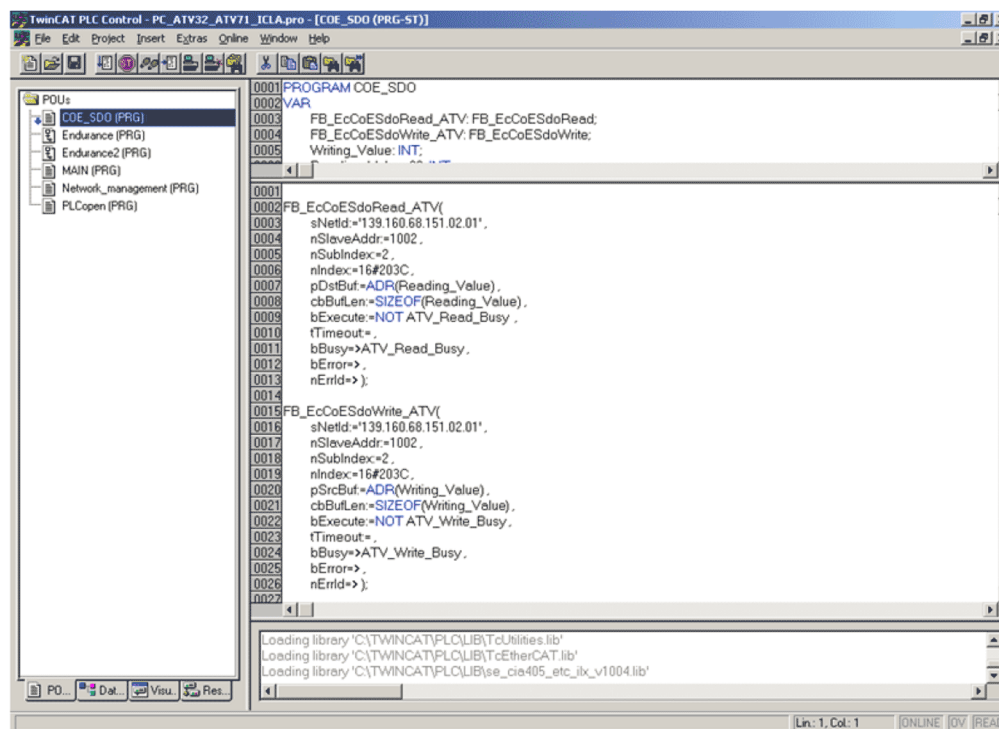

Example for exchanges with ESM states

The screenshot displays the TwinCAT PLC Control software interface. The main window shows a ladder logic program for a network management task. The project tree on the left lists several programs: COE_SDO (PRG), Endurance (PRG), Endurance2 (PRG), Endurance3 (PRG), MAIN (PRG), Network_management (PRG), and test (PRG). The main editor shows the following code:

```

0018 boot_32: BOOL;
0019 boot_71: BOOL;
0020 FB_EcSetSlaveState_ATV71: FB_EcSetSlaveState;
0021 init_71: BOOL;
0022 Preop_71: BOOL;
0023 Safeop_71: BOOL;
0024 op_71: BOOL;

0001 FB_GetLocalAmsNetId_1(
0002   bExecute:=TRUE,
0003   tTimeout=,
0004   bBusy=>,
0005   bError=>,
0006   nErrId=>,
0007   AddrString=>SnetId,
0008   AddrBytes=>);
0009 SnetId:=REPLACE(SnetId, '3', 1, LEN(SnetId)-2);
0010
0011 (*EC_DEVICE_STATE_INIT 0x01 Set slave in Init state.
0012 EC_DEVICE_STATE_PREOP 0x02 Set slave in pre-operational state.
0013 EC_DEVICE_STATE_BOOTSTRAP 0x03 Set slave in bootstrap state.
0014 EC_DEVICE_STATE_SAFEOP 0x04 Set slave in safe-operational state.
0015 EC_DEVICE_STATE_OP 0x08 Set slave in operational state.
0016 EC_DEVICE_STATE_ERROR 0x10 If the error bit at the EtherCAT Slave is set in the status byte ( currState.deviceState AND EC_DI
0017 FB_EcSetMasterState_1(
0018   sNetId:=SnetId,
0019   bExecute=,
0020   tTimeout=,
0021   reqState=,
0022   bBusy=>,
0023   bError=>,
0024   nErrId=>,
0025   currState=>);
0026

```

At the bottom of the window, there is a status bar showing "Lin.: 9, Col.: 48" and buttons for "ONLINE", "OV", and "READ". A message box at the bottom indicates "Loading library 'C:\TWINCAT\PLC\LIB\TcSystem.lib'" and "Loading library 'C:\TWINCAT\PLC\LIB\TcUtilities.lib'".

Diagnostics and monitoring



5

What's in this Chapter?

This chapter contains the following topics:

Topic	Page
LED Indicators	38
Communication Diagnostics	40
Control-Signal Diagnostics	42

LED Indicators

The following figure describes the LEDs status module:

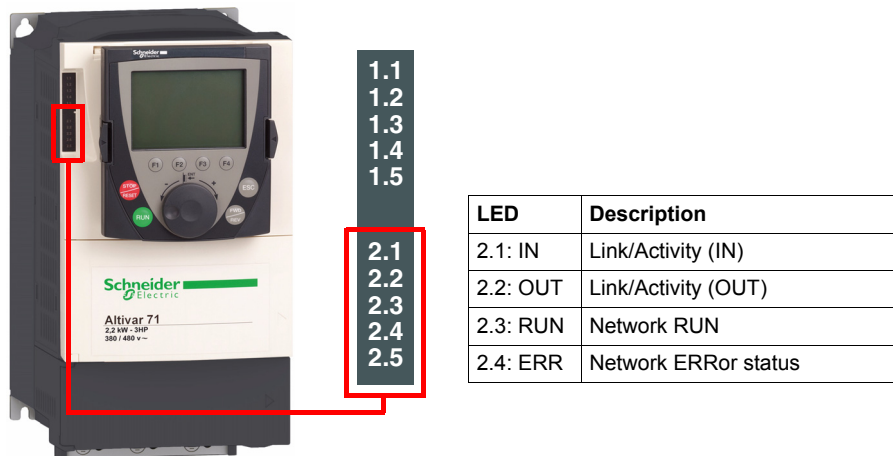

LEDs 2.1 and 2.2: Link / Activity

These LEDs indicate the status of the EtherCAT port A (IN) and EtherCAT port B (OUT)

Color & Status	Description
OFF	No link
Green ON	Link, no activity
Green Flickering	Link, activity

LED 2.3: RUN Status

Color & Status	Description
OFF	EtherCAT state: INIT
Green blinking	EtherCAT state: PRE-OPERATIONAL
Green single flashing	EtherCAT state: SAFE-OPERATIONAL.
Green ON	EtherCAT state: OPERATIONAL

LED 2.4: Network ERRor Status

Color & Status	Description
OFF	No detected fault
Red blinking	Invalid configuration
Red single flashing	Local error (such as synchronization error)
Red double flashing	Watchdog timeout

LED Behavior Detail

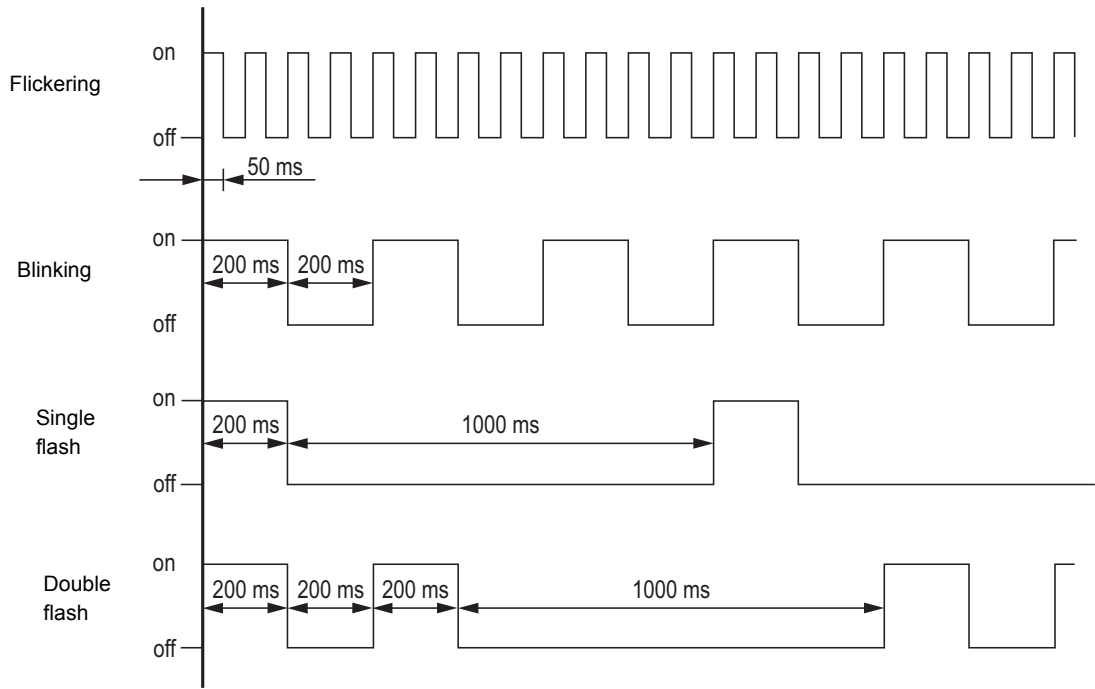

Communication Diagnostics

A properly operating fieldbus is essential for evaluating operating and detected faults messages.

Connections for Fieldbus Mode

If the product cannot be addressed via the fieldbus, first check the connections. The product manual contains the technical data of the device and information on network and device installation. Check the following:

- 24Vdc power supply (if used)
- Power connections to the device
- Fieldbus cable and fieldbus wiring
- Network connection to the device

Command and Reference Channels

Drive's command and reference parameters are managed on a channel-by-channel basis.

It is possible to identify the last value written for each channel and each command or reference parameter:

Parameter name	Parameter code				
	Taken into account by the drive	Modbus	CANopen	Communic. card	PLC card
Control word	(C Nd)	(C Nd 1)	(C Nd 2)	(C Nd 3)	(C Nd 4)
Extended control word	(C N 1)	(C N 1 1)	(C N 1 2)	(C N 1 3)	(C N 1 4)
Speed reference (rpm)	(L F r d)	(L F r d 1)	(L F r d 2)	(L F r d 3)	(L F r d 4)
Frequency reference (0.1 Hz)	(L F r)	(L F r 1)	(L F r 2)	(L F r 3)	(L F r 4)
PI regulator reference	(P I S P)	(P I r 1)	(P I r 2)	(P I r 3)	(P I r 4)
Analog multiplier reference	(P F r)	(P F r 1)	(P F r 2)	(P F r 3)	(P F r 4)

Monitoring of Communication Channels

Communication channels are monitored if they are involved in one of the following parameters:

- The control word ([Cmd value] (C Nd)) from the active command channel
- The control word containing the command switch (bit configured on [Cmd switching] (C C 5))
- The control word containing the switch for reference 1'1B (bit configured on [Ref 1B switching] (r C b))
- The control word containing the switch for reference 1'2 (bit configured on [Ref. 2 switching] (r F C))
- The frequency or speed reference ([HMI Frequency ref.] (L F r) or [Nominal speed value] (L F r d)) from the active reference channel
- Summing frequency or speed reference ([HMI Frequency ref.] (L F r) or [Nominal speed value] (L F r d)) 2 (assigned to [Summing ref. 2] (S A 2))
- Summing frequency or speed reference ([HMI Frequency ref.] (L F r) or [Nominal speed value] (L F r d)) 3 (assigned to [Summing ref. 3] (S A 3))
- Subtracting frequency or speed reference ([HMI Frequency ref.] (L F r) or [Nominal speed value] (L F r d)) 2 (assigned to [Subtract ref. 2] (d A 2))
- Subtracting frequency or speed reference ([HMI Frequency ref.] (L F r) or [Nominal speed value] (L F r d)) 3 (assigned to [Subtract ref. 3] (d A 3))
- The PID regulator reference [HMI PID reference] (P I S P)
- The PID regulator feedback ([AI Virtual 2] (A I U 2))
- The reference multiplication coefficient ([Multiplying coeff.] (P F r)) 2 (assigned to [Multiplier ref. 2] (P A 2))
- The reference multiplication coefficient ([Multiplying coeff.] (P F r)) 3 (assigned to [Multiplier ref. 3] (P A 3))

As soon as one of these parameters has been written once to a communication channel, it activates monitoring for that channel.

If a communication alarm is sent (in accordance with the protocol criteria) by a monitored port or network card, the drive will trigger a communication interruption.

The drive reacts according to the communication interruption configuration (detected fault, maintenance, fallback, etc.)

If a communication alarm occurs on a channel that is not being monitored, the drive will not trigger a communication interruption.

Communication Interruptions

Communication interruptions are displayed by **[Past fault 1] (d P I)** indicator of the integrated display terminal or graphic display terminal or by Emergency object (EMCY), described in Emergency Object (EMCY), page 52.

In factory settings, an EtherCAT communication interruption triggers a drive detected fault that can be cleared **[Network fault mgt] (C L L)** and a freewheel stop.

The response of the drive in the event of an EtherCAT communication interruption can be changed:

- Drive fault **[Network fault mgt] (C L L)** (freewheel stop, stop on ramp, fast stop or DC injection stop).
- No drive detected fault (stop, maintain, fallback).

In the event of a **[Network fault mgt] (C L L)**, the drive sends an EMCY message to the EtherCAT master, see Emergency Object (EMCY), page 52.

Communication detected Faults: CnF and ILF

After a detected fault occurred, here are the values to read:

Parameter	Description	Possible values and descriptions
[Option int link] (I L F)	This parameter indicates a detected error and can be cleared: It needs a drive Power Off / Power On.	18: Interface connection timeout 19: EEPROM/NVS detected fault 21: 'No memory' or 'background watchdog' detected fault
[Internal link fault 1] (I L F 1)	displays the trip that occurred on option card no. 1 (directly mounted on the drive)	
[Internal link fault 2] (I L F 2)	displays the trip that occurred on option card no. 2	
[Com. network] (C n F) The parameter [Com. network] (C n F) is displayed on the display terminal (graphic only): [1.10 DIAGNOSTICS] (d G E -) menu, [MORE FAULT INFO] (R F I -) submenu.	This parameter indicates that a network interruption occurred. A value is recorded depending of the interruption type. When the detected fault has disappeared, the option writes 0: No network interruption. Note: (C n F) is available only in "operational" state and if the motor is running.	0: No network interruption 1: Unspecified interruption 11: lost of link (2ports) 23: invalid Sync Manager configuration 25: No valid outputs 27: Sync Manager watchdog (1port) 29: invalid Sync Manager out configuration 30: invalid Sync Manager in configuration 31: invalid watchdog configuration 36: invalid input mapping 37: invalid output mapping 38: inconsistent settings 43: No valid inputs and outputs 44: Sync error 80: EE no access 81: EE error 96: Invalid State machine change

EtherCAT state machine

For the status, see **[EthCAT slave status] (E C 5 5)** page 20.

For the EtherCAT state machine diagram, see page 50.

Enabling of Communication Channels

A communication channel is enabled once all the parameters involved have been written at least one time.

The drive is only able to start if all channels involved in command and reference are enabled.

Example:

A drive in DSP402 profile is connected to an active communication channel.

It is mandatory to write at least one time the reference and the command in order to switch from "4-Switched on" to "5-Operation enabled" state

A communication channel is disabled:

- In the event of a communication alarm
- In "forced local" mode.

Note: On exiting "forced local" mode:

- The drive copies the run commands, the direction and the forced local reference to the active channel (maintained).
- Monitoring of the active command and reference channels resumes following a time delay **[Time-out forc. local] (F L D E)**.
- Drive control only takes effect once the drive has received the reference and the command from the active channel.

Control-Signal Diagnostics

On the terminal, the **[1.2 - MONITORING]** (**Π Ω π -**) menu (**[COMMUNICATION MAP]** (**Σ Π Π -**) submenu) can be used to display control-signal diagnostic information between the Altivar drive and the EtherCAT master:

- Active command channel **[Command channel]** (**Σ Π δ Σ**)
- Value of the control word (CMD) from the active command channel **[Cmd value]** (**Σ Π δ**)
- Active target channel **[Active ref. channel]** (**ρ F Σ Σ**)
- Value of the target from the active target channel **[Frequency ref.]** (**F ρ H**)
- Value of the status word **[ETA state word]** (**E ρ A**)
- Values of the four parameters selected by the user (W---)
- The **[COM. SCANNER INPUT MAP]** submenu: contains the parameter value mapped DRIVE scanner (NMAx).
- The **[COM SCAN OUTPUT MAP]** submenu: contains the parameter value mapped DRIVE scanner (NCAx).
- In the **[CMD. WORD IMAGE]** submenu: control words from all channels
- In the **[FREQ. REF. WORD MAP]** submenu: frequency targets produced by all channels

Example

Example of the display of communication diagnostic information:

RUN	nEt	+50.00Hz	80A
COMMUNICATION MAP			
Command Channel	:		Com.Card
Cmd value	:		000FHex
Active ref. channel	:		Com.Card
Frequency ref.	:		500.0Hz
ETA state word	:		8627Hex
Code		Quick	▼
W3204	:		73
W3205	:		725
W7132	:		0000Hex
W0	:		----
COM. SCANNER INPUT MAP			
COM SCAN OUTPUT MAP			
CMD. WORD IMAGE			
FREQ. REF. WORD MAP			
MODBUS NETWORK DIAG			
MODBUS HMI DIAG			

Control Word Display

The **[Command Channel]** (**Σ Π δ Σ**) parameter indicates the active command channel.

The **[Cmd value]** (**Σ Π δ**) parameter indicates the hexadecimal value of the control word (CMD) used to control the drive.

The **[CMD. WORD IMAGE]** (**Σ I -**) submenu (**[CANopen cmd.]** (**Σ Π δ ρ**) parameter) is used to display the hexadecimal value of the control word sent by CANopen.

Frequency Target Display

The **[Active ref. channel]** (**ρ F Σ Σ**) parameter indicates the active target channel.

The **[Frequency ref]** parameter indicates the value (in 0.1 Hz units) of the frequency target (LFR) used to control the drive.

The **[FREQ. REF. WORD MAP]** submenu (**[COM. card cmd]** parameter) is used to display the value (in 0.1 Hz units) of the speed target sent by the network.

Status Word Display

The **[ETA state word] (E L R)** parameter gives the value of the status word (ETA).

Display of the Parameters Selected by the User

The four **[W...]** parameters give the value of the four monitored words selected by the user.

The address and display format of these parameters can be configured in the **[3.3 MONITORING CONFIG.] (P L F -)** menu (**[COM. MAP CONFIG.] (R D L -)** submenu).

The value of a monitored word equals “...” if:

- Monitoring has not been activated (address equals W0),
- The parameter is protected,
- The parameter is not known (example: W3200).

Profiles



6

What's in this Chapter?

This chapter contains the following topics:

Topic	Page
Definition of a Profile	46
Functional Profiles Supported by the Altivar 61/71	47

Definition of a Profile

There are three types of profile:

- Communication profiles
- Functional profiles
- Application profiles

Communication Profiles

A communication profile describes the characteristics of the bus or network:

- Cables
- Connectors
- Electrical characteristics
- Access protocol
- Addressing system
- Periodic exchange service
- Messaging service
- ...

A communication profile is unique to a type of network (Modbus TCP, Profibus DP, etc.) and is used by various different types of device.

Functional Profiles

A functional profile describes the behavior of a type of device. It defines:

- Functions
- Parameters (name, format, unit, type, etc.)
- Periodic I/O variables
- State chart(s)
- ...

A functional profile is common to all members of a device family (variable speed drives, encoders, I/O modules, displays, etc.).

They can feature common or similar parts. The standardized (IEC 61800-7) functional profiles of variable speed drives are:

- CiA402
- PROFIDRIVE
- CIP

DRIVECOM has been available since 1991.

CiA402 "Device profile for drives and motion control" represents the next stage of this standard's development and is now part of the IEC 61800-7 standard.

Some protocols also support the ODVA (Open DeviceNet Vendor Association) profile.

Application Profiles

Application profiles define in their entirety the services to be provided by the devices on a machine. For example, "CiA DSP 417-2 V 1.01 part 2: CANopen application profile for lift control systems - virtual device definitions".

Interchangeability

The aim of communication and functional profiles is to achieve interchangeability of the devices connected via the network.

Functional Profiles Supported by the Altivar 61/71

I/O Profile

Using the I/O profile simplifies PLC programming.

The I/O profile mirrors the use of the terminal strip for control by utilizing 1 bit to control a function.

With an Altivar 61/71, the I/O profile can also be used when controlling via a network.

The drive starts up as soon as the run command is sent.

15 bits of the control word (bits 1 to 15) can be assigned to a specific function.

This profile can be developed for simultaneous control of the drive via:

- The terminals
- The Modbus control word
- The CANopen control word
- The network module control word

The I/O profile is supported by the drive itself and therefore in turn by all the communication ports (integrated Modbus, CANopen, Ethernet, Profibus DP, DeviceNet, EtherCAT communication modules).

CiA402 Profile

The drive only starts up following a command sequence.

The control word is standardized.

5 bits of the control word (bits 11 to 15) can be assigned to a function.

The CiA402 profile is supported by the drive itself and therefore in turn by all the communication ports (integrated Modbus, CANopen, Ethernet, Profibus DP, DeviceNet, EtherCAT communication modules).

The Altivar 61/71 supports the CiA402 profile's "Velocity mode".

In the CiA402 profile, there are two modes that are specific to the Altivar 61/71 and characterize command and reference management:

- Separate mode **[Separate] (SEP)**
- Not separate mode **[Not separ.] (SIN)**

Detailed Description of Services



8

What's in this Chapter?

This chapter contains the following topics:

Topic	Page
EtherCAT State Machine (ESM)	50
Emergency Object (EMCY)	52

EtherCAT State Machine (ESM)

ESM Diagram

The EtherCAT State machine coordinates the master and slave applications at start up and during operation. State changes are typically initiated by requests of the master. They are acknowledged by the local application after the associated operations have been executed.

Description of the states management

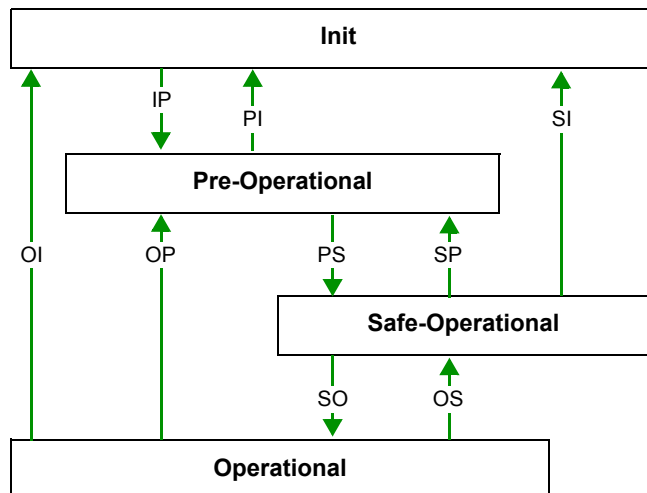

ESM states

The state **Init** defines the foundation of the communication relationship between the master and the slaves at the application layer. Direct communication between the master and the slave is impossible at the application layer. The master uses the Init state to initialize a set of configuration registers of the EtherCAT slave controllers. If the slaves support mailbox services, the Sync Manager is also configured in this state.

In the **Pre-Operational** state, the mailbox is active. Both master and slave use the mailbox and the corresponding protocol to interchange application-specific initialization data and parameters. In this state, process data communication is not possible.

If the drive does not receive a valid mapping for the process data from the EtherCAT master, it remains in this state.

In the **Safe-Operational** state, the slave application provides current input data such as limit switch data. Output data of the master are ignored in this state. This state is not a safety function.

In the state **Operational**, the slave applications deliver current input data and the drive processes the current output data from the drive, such as speed setpoint.

State transitions

State transition	Local management service	Value
IP	Start Mailbox Communication	0x02
PI	Stop Mailbox Communication	0x01
PS	Start Input Update	0x04
SP	Stop Input Update	0x02
SO	Start Output Update	0x08
OS	Stop Output Update	0x04
OP	Stop Output Update and Stop Input Update	0x02
SI	Stop Input Update, Stop Mailbox Communication	0x01
OI	Stop Input Update, Stop Output Update, Stop Mailbox Communication	0x01

ESM states management

The ESM states are managed with the library: TC EtherCAT lib. See the example, step 15 page [34](#).

ESM states and communication interruptions

The ESM states are managed with the library: TC EtherCAT lib. See the example, step 15 page [34](#).
Some transitions in the ESM state chart will trigger a communication interruption.

These transitions suppress a service, which can be used to control the drive.

A detected fault is triggered in order to avoid losing control of the drive (only if the drive is running).

State transition	Service lost	[Com. network] (C n F)
PI	SDO	No possible C n F
SI	SDO, TPDO	
SP	TPDO	
OS	RPDO	If drive was enabled (E L A = 16#xxx7) then the C n F value must be updated to 0x0060
OP	PDO	
OI	SDO, PDO	

Depending on the communication status of the drive, the following services are available:

	Init	Pre-operational	Safe-Operational	Operational
PDO			TPDO, inputs only active, no outputs to drive active	X
SDO		X	X	X
Emergency (EMCY)		X	X	X

Note: If PDO are deactivated, it is not possible to control the drive by SDO.

Emergency Object (EMCY)

Master ⇄ Drive

COB-ID	Byte 0	Byte 1	Byte 2	Byte 3	Byte 4	Byte 5	Byte 6	Byte 7
128 (16#080) +NODE-ID	Fault code (Errd)		Error register	0	0	0	0	0
	LSB	MSB	Bit 0 = 0 (no fault) or 1 (fault)	-	-	-	-	-

An EMCY object is sent by the drive to other devices, with a high priority, every time a detected fault appears (byte 2/bit 0 = 1) or disappears (byte 2/bit 0 = 0). This is the case in particular for “Heartbeat” or “Life Guard” type detected faults. An Emergency object is not repeated.

The detected error code parameter Errd (CANopen index = 16#2038/7) is described in the table below:

EMCY detected error code (Errd)	Description (accessible also in [Past fault 1] (dP I) see programming manual)
16#000	[No fault] (nOF)
16#100	[Precharge] (CrF)
16#100	[Motor overload] (OLF)
16#100	[Overspeed] (SOF)
16#100	[DB unit sh. circuit] (bUF)
16#100	[Diff. I fault] (dCF)
16#100	[IGBT desaturation] (HdF)
16#100	[internal- CPU] (InFE)
16#100	[BR overload] (bOF)
16#100	[Ch.sw. fault] (CSF)
16#223	[IGBT short circuit] (SCF4)
16#231	[Overcurrent] (OCF)
16#232	[Motor short circuit] (SCF1)
16#232	[Impedant sh. circuit] (SCF2)
16#232	[Motor short circuit] (SCF5)
16#233	[Ground short circuit] (SCF3)
16#311	[Mains overvoltage] (OSF)
16#312	[Undervoltage] (USF)
16#313	[Input phase loss] (PHF)
16#331	[Overbraking] (ObF)
16#331	[1 output phase loss] (OPF1)
16#331	[3out ph loss] (OPF2)
16#421	[Drive overheat] (OHF)
16#421	[IGBT overheat] (tJF)
16#431	[PTC1 overheat] (OtF1)
16#431	[PTC2 overheat] (OtF2)
16#431	[PTC fault] (OtFL)
16#500	[Internal-hard init.] (InF7)
16#500	[Out. contact. stuck] (FCF1)
16#500	[Out. contact. open.] (FCF2)
16#500	[Int. T meas.] (InFC)
16#500	[Thyr. soft charge] (CrF2)
16#500	[input contactor] (LCF)
16#510	[Internal-ctrl supply] (InF8)
16#521	[Internal- I measure] (InF9)
16#521	[Internal-mains circuit] (InFA)
16#0000	[No fault] (nOF)
16#1000	[Precharge] (CrF)
16#1000	[Motor overload] (OLF)

EMCY detected error code (Errd)	Description (accessible also in [Past fault 1] (d P l) see programming manual)
16#1000	[Overspeed] (SOF)
16#1000	[DB unit sh. circuit] (bUF)
16#1000	[Diff. I fault] (dCF)
16#1000	[IGBT desaturation] (HdF)
16#1000	[internal- CPU] (InFE)
16#1000	[BR overload] (bOF)
16#1000	[Ch.sw. fault] (CSF)
16#2230	[IGBT short circuit] (SCF4)
16#2310	[Overcurrent] (OCF)
16#2320	[Motor short circuit] (SCF1)
16#2320	[Impedant sh. circuit] (SCF2)
16#2320	[Motor short circuit] (SCF5)
16#2330	[Ground short circuit] (SCF3)
16#3110	[Mains overvoltage] (OSF)
16#3120	[Undervoltage] (USF)
16#3130	[Input phase loss] (PHF)
16#3310	[Overbraking] (ObF)
16#3310	[1 output phase loss] (OPF1)
16#3310	[3out ph loss] (OPF2)
16#4210	[Drive overheat] (OHF)
16#4210	[IGBT overheat] (tJF)
16#4310	[PTC1 overheat] (OtF1)
16#4310	[PTC2 overheat] (OtF2)
16#4310	[PTC fault] (OtFL)
16#5000	[Internal-hard init.] (InF7)
16#5000	[Out. contact. stuck] (FCF1)
16#5000	[Out. contact. open.] (FCF2)
16#5000	[Int. T meas.] (InFC)
16#5000	[Thyr. soft charge] (CrF2)
16#5000	[input contactor] (LCF)
16#5100	[Internal-ctrl supply] (InF8)
16#5210	[Internal- I measure] (InF9)
16#5210	[Internal-mains circuit] (InFA)
16#5210	[Internal- th. sensor] (InFb)
16#5530	[Control Eeprom] (EEF1)
16#5530	[Power Eeprom] (EEF2)
16#6100	[Calibration error] (InF)
16#6100	[Rating error] (InF1)
16#6100	[PWR Calib.] (InF2)
16#6100	[Int.serial link] (InF3)
16#6100	[Int.Mfg area] (InF4)
16#6100	[Cards pairing] (HCF)
16#6300	[Incorrect config.] (CFF)
16#6300	[Invalid config.] (CFI)
16#7000	[Internal-option] (InF6)
16#7110	[Brake feedback] (brF)
16#7300	[Load slipping] (AnF)
16#7300	[AI2 4-20mA loss] (LFF2)
16#7300	[PTC1 probe] (PtF1)
16#7300	[PTC2 probe] (PtF2)

EMCY detected error code (Errd)	Description (accessible also in [Past fault 1] (d P I) see programming manual)
16#7300	[LI6=PTC probe] (PtFL)
16#7300	[AI2 input] (AI2F)
16#7300	[AI3 4-20mA loss] (LFF3)
16#7300	[AI4 4-20mA loss] (LFF4)
16#7310	[Speed fdback loss] (SPF)
16#7310	[Enc. coupl.] (ECF)
16#7310	[Encoder] (EnF)
16#7510	[Modbus com.] (SLF1)
16#7510	[HMI com.] (SLF3)
16#7520	[int. com.link] (ILF)
16#7520	[Com. network] (CnF)
16#7530	[PC com.] (SLF2)
16#8100	[CAN com.] (COF)
16#9000	[External flt-LI/Bit] (EPF1)
16#9000	[External fault com.] (EPF2)
16#9000	[Application fault] (APF)
16#FF00	[Auto-tuning] (tnF)
16#FF01	[Brake control] (bLF)
16#FF02	[Torque/current lim] (SSF)
16#FF02	[Torque time-out] (SrF)
16#FF03	[Power removal] (PrF)
16#FF80	[Load fault] (dLF)

Object Dictionary



9

What's in this Chapter?

This chapter contains the following topics:

Topic	Page
Introduction	56
Communication Profile Area	57
RPDO: Receive PDO	57
TPDO: Transmit PDO	57
Sync Manager	58
Manufacturer Specific Area	58
Application Profile Area	58

Introduction

The description object dictionary is made of separate chapters:

- Communication profile area
- RPDO
- TPDO
- Manufacturer specific
- Application profile (CiA402)

Index	Object
16#0000	Unused
16#0001 - 16#001F	Static data types
16#0020 - 16#003F	Complex data types
16#0040 - 16#005F	Unused (Manufacturer specific complex data types)
16#0060 - 16#007F	Device profile specific static data types
16#0080 - 16#009F	Device profile specific complex data types
16#00A0 - 16#0FFF	Reserved for further use
16#1000 - 16#1FFF	Communication profile area
16#2000 - 16#5FFF	ATV61/71 specific profile area
16#6000 - 16#9FFF	Standardised device profile area
16#A000 - 16#FFFF	Reserved for further use

Communication Profile Area

Index	Sub-Index	Access	Type	Default value	Description
16#1000	16#00	R	unsigned32	16#00410192	Device type and profile: Bits 16-23 = Device type mode Bits 00-15 = Device profile number (402)
16#1001	16#00	R	unsigned8	16#00	Detected error register: detected error (1) or no detected error (0)
16#1003	16#00	R	unsigned32	16#00000005	Number of detected errors: No detected error (0) or one or more detected errors (>0) in object 16#1003; only the value 0 can be written
	16#01 to 16#10	R	unsigned32	16#00000000	Standard detected error Field: Bits 16-31 = Additional information (all 0s) Bits 00-15 = detected error code (Errd)
16#1008	16#00	R	visible string	ATV61/71●●●●●●	Device name, ATV61/71 reference
16#1018	16#00	R	unsigned32		Identity object
	16#01	R	unsigned32	16#0800005A	Vendor ID
	16#02	R	unsigned32	16#00000020	Product code
	16#04	R	unsigned32		Revision number
	16#05	R	unsigned32		Serial number

RPDO: Receive PDO

Index	Sub-Index	Access	Type	Default value	Description
16#1600	16#00	R/W	unsigned8	16#02	Receive PDO mapping - Number of mapped objects: 0 to 4 objects can be mapped for this PDO
	16#01	R/W	unsigned32	16#60400010	Receive PDO mapping - 1st mapped object: Control word "CMD" (16#6040)
	16#02	R/W	unsigned32	16#60420010	Receive PDO mapping - 2nd mapped object: Velocity reference "LFRD" (16#6042)
	16#03	R/W	unsigned32	16#00000000	Receive PDO mapping: 3rd mapped object
	16#04	R/W	unsigned32	16#00000000	Receive PDO mapping: 4th mapped object
	16#05	R/W	unsigned32	16#00000000	Receive PDO mapping: 5rd mapped object
	16#06	R/W	unsigned32	16#00000000	Receive PDO mapping: 6th mapped object
	16#07	R/W	unsigned32	16#00000000	Receive PDO mapping: 7th mapped object
	16#08	R/W	unsigned32	16#00000000	Receive PDO mapping: 8th mapped object

TPDO: Transmit PDO

Index	Sub-Index	Access	Type	Default value	Description
16#1A00	16#00	R/W	unsigned8	16#02	Transmit PDO mapping - Number of mapped objects.
	16#01	R/W	unsigned32	16#60410010	Transmit PDO mapping - 1st mapped object: Status word "ETA" (16#6041)
	16#02	R/W	unsigned32	16#60440010	Transmit PDO mapping - 2nd mapped object: Output speed "RFRD" (16#6044/00) default value
	16#03	R/W	unsigned32	16#00000000	Transmit PDO mapping: 3rd mapped object
	16#04	R/W	unsigned32	16#00000000	Transmit PDO mapping: 4th mapped object
	16#05	R/W	unsigned32	16#00000000	Transmit PDO mapping: 5th mapped object
	16#06	R/W	unsigned32	16#00000000	Transmit PDO mapping: 6th mapped object
	16#07	R/W	unsigned32	16#00000000	Transmit PDO mapping: 7th mapped object
	16#08	R/W	unsigned32	16#00000000	Transmit PDO mapping: 8th mapped object

Sync Manager

Index	Sub-Index	Access	Type	Default value	Description
16#1C12	16#00	R	unsigned8		Sync manager channel 2. Number of assigned RPDO (0 or 1)
	16#01	R	unsigned16		Assigned RPDO number 1
16#1C13	16#00	R	unsigned8		Sync manager channel 3. Number of assigned TPDO (0 or 1)
	16#01	R	unsigned16		Assigned TPDO number 1

Manufacturer Specific Area

- The ATV61/71 specific profile area range is 16#2000 to 16#5FFF.
- The ATV61/71 parameters are based on Modbus addresses and CANopen addresses.
- To get the address list, download on www.schneider-electric.com, the ATV61/71 Communication parameters manual.
 - ATV61 document reference: 1760661
 - ATV71 document reference: 1755861

Application Profile Area

These area contains standardized parameters in conformance with CiA402 velocity mode.

Index	Description	
16#603F	Detected error code	
16#6040	Control Word	
16#6041	Status Word	
16#6042	Target velocity	
16#6043	Velocity demand	
16#6044	Control Effort	
16#6046	01	Velocity min. amount
	02	Velocity max amount
16#6048	Velocity acceleration	
	01	Delta speed
	02	Delta time
16#6049	Velocity deceleration	
	01	Delta speed
	02	Delta time
16#604b	Set Point factor	
	01	Set Point factor numerator
	02	Set Point factor denominator
16#605A	Quick stop option code	
16#605C	Disable option code	
16#6060	Modes of operation	
16#6077	Torque actual value	
16#6502	Supported drive modes	

Glossary

10

Term	Definition
AL	Application Layer
CAN	Controller Area Network is an internally standardized serial bus system
CNC	Computer Numerical Control
COB	Communication Object. A unit of transportation in a CAN network. Data must be sent across a CAN Network inside a COB. There are 2048 different COB's in a CAN network. A COB can contain at most 8 bytes of data
COB-ID	Each COB is uniquely identified in a CAN network by a number called the COB Identifier (COB-ID). The COB-ID determines the priority of that COB for the MAC sub-layer
CoDeSys	Controller Development System
CoE	CAN application layer over EtherCAT
COF	CANopen Communication interruption
DC	Distributed Clock
DINT	Signed Double INTEger
DL	DataLink layer
ENI	EtherCAT Network Information (network configuration in XML format, generated by the master)
EoE	Ethernet over EtherCAT
ERCO	Error Code
ESI	EtherCAT Slave Information (device description in XML format)
ESM	EtherCAT State Machine
INT	Signed INTEger
NC	Numerical Control
NMT	NMT Network Management. One of the service elements of the application layer in the CAN Reference Model. The NMT serves to configure, initialise, and handle detected errors in a CAN network
OSI	Open Systems Interconnection
PDO	Process Data Objects
PL	Physical Layer
PLC	Programmable Logic controller
RPDO	Receive PDO
SDO	Service Data Objects
SoMove	Windows setup software for drives and softstarters You can download it on www.schneider-electric.com
ST	Structured Language
SYNC	Synchronization Object
TPDO	Transmit PDO
TwinCAT	Windows Control and Automation Technology system software copyright Beckhoff®
UDINT	Unsigned Double INTEger
UINT	Unsigned INTEger
XML	eXtended Markup Language

