

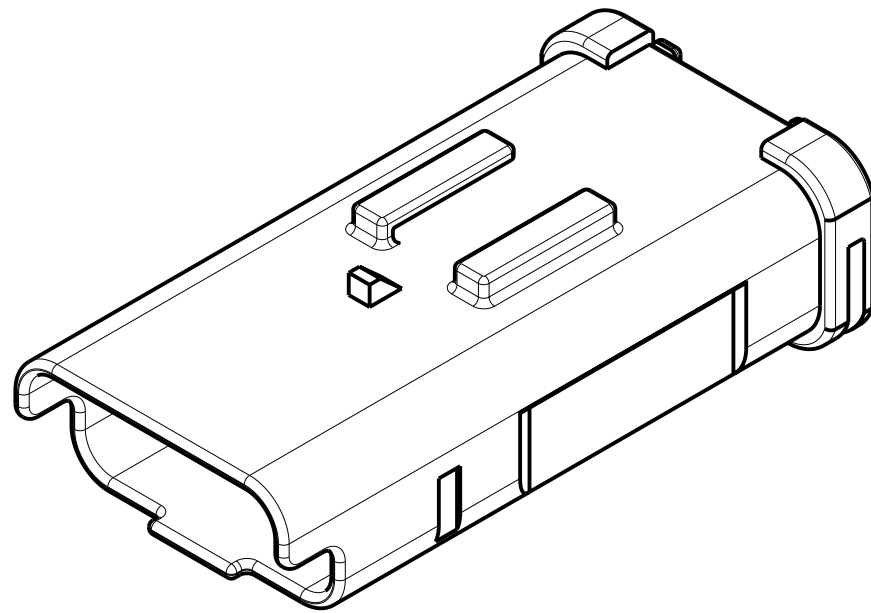

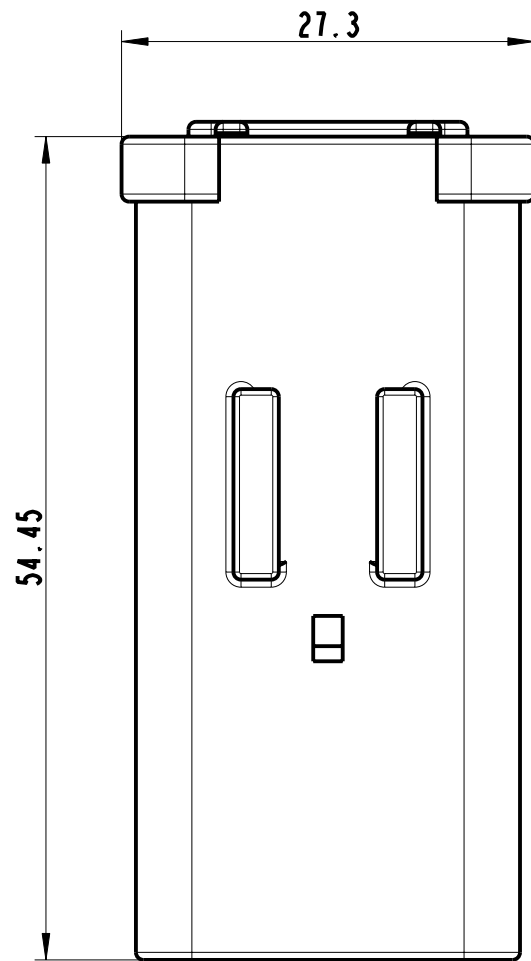

8 7 6 5 4 3 2 1

F
E
D
C
B
A

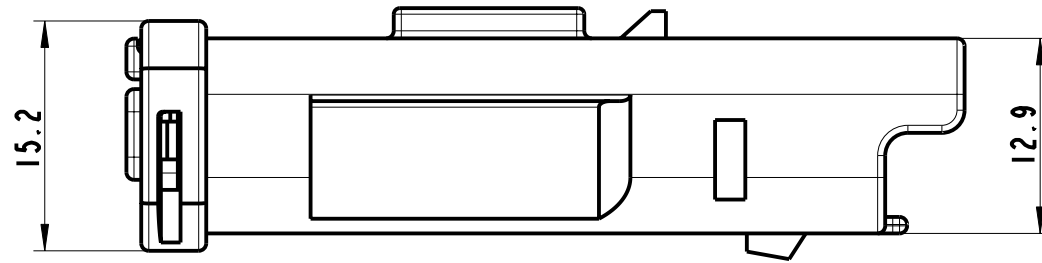
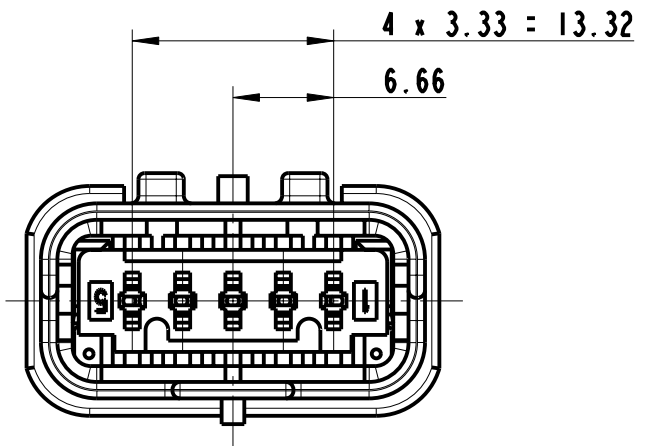

DO NOT SCALE DRAWING	 www.fciconnect.com	 ISO PROJECTION 2:1	SCALE
TITLE		 DIMENSION IN MILLIMETERS A3	DWG SIZE
5 way male coupling	CATALOG NUMBER		SHEET
	--		1 of 1
<small>THIS DRAWING AND ALL OTHER INFORMATION CONTAINED THEREIN IS PROPRIETARY AND THE PROPERTY OF FCI. This drawing may not be copied, reproduced or disclosed to any third party without the expressed written permission of FCI. © FCI April 1999</small>			

8 7 6 5 4 3 2 1