

Datasheet

USB2 Gender Changer Sockets

RS Stock number 862-1579



Description:

These gender changer sockets are available in both USB2 AàB and BàA versions. Designed to accommodate the integration of USB2 data feeds into professional equipment for broadcast, lighting and audio applications. Construction is of rugged zinc/nickel metal XLR housings fitting the universally popular 23.6mm diameter XLR panel cut outs. These connectors can be mounted at rear or front of panel.

Part No: 8621579

A→B GENDER CHANGE FEEDTHROUGH SOCKET

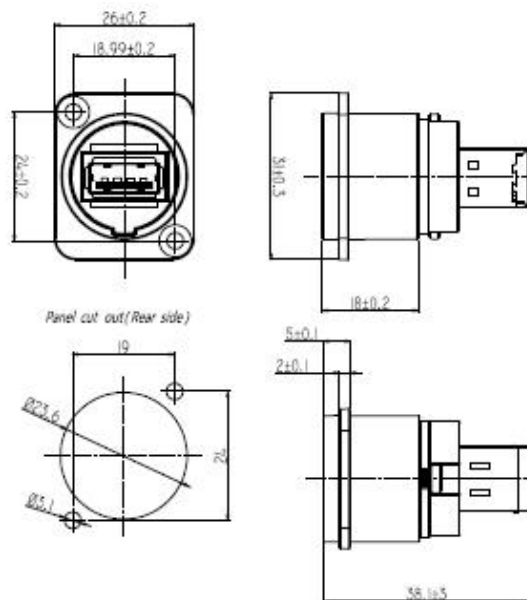

Part No: 8621573

B→A GENDER CHANGE FEEDTHROUGH SOCKET

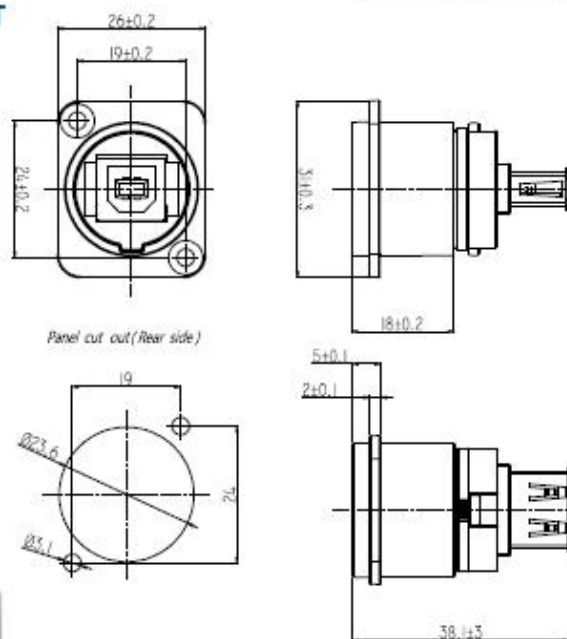

USB SPECIFICATION

PIN No.	USB A	USB B
1	Vcc	Vcc
2	D-	D-
3	D+	D+
4	GROUND	GROUND

