

# STANLEY®

®

CATALOGUE 2011

## STANLEY®

# FatMax®

STANLEY MAKE SOMETHING GREAT™

STANLEY



# new and innovative

**FatMax** 5 in 1 Hacksaw on page 6



**FatMax** Folding Retractable Knife on page 4



Claw Hammer with **70% bigger** head on page 8



**FatMax** 4 in 1 Cantilever Rolling Workshop on page 24



# STANLEY CATALOGUE 2011 INDEX

## MEASURING

TAPE RULES - POWERLOCK	Pg 1
TAPE RULES - TYLON	Pg 1
TAPES - DIPPING	Pg 1
TAPE RULE - REPLACEMENT BLADE	Pg 1
TAPE RULES - LONG	Pg 1
TAPE RULES - FATMAX	Pg 1

## LAYOUT TOOLS

LEVELS - BOX & FATMAX + FOAMCAST	Pg 2
BEVEL	Pg 2
PLUMB BOBS	Pg 2
LEVELS - LINE & TORPEDO	Pg 2
MARKING GAUGE	Pg 2
SQUARES	Pg 3
CHALK REELS & CHALK	Pg 3

## KNIVES & BLADES

KNIVES	Pg 4, 5
BLADES + KNIVES	Pg 5

## DECORATORS TOOLS

SCRAPERS & PUTTY KNIVES	Pg 5, 6
-------------------------	---------

## SAWS

SAWS - CROSSCUT, JET, RIP, PANEL & BACK	Pg 6
SAWS - OTHER	Pg 6, 7
MITRE BOXES	Pg 7

## HAMMERS

HAMMERS - BALL PEIN	Pg 8
HAMMERS - DRILLING	Pg 8
HAMMERS - CLUB & MALLET	Pg 8
HAMMERS - ENGINEERS	Pg 8
HAMMERS - CLAW	Pg 8

## MECHANICS TOOLS

SOCKET & SPANNER SETS	Pg 9
SOCKETS - PP HANGER - 13MM 1/2" DRIVE	Pg 9
SPANNERS	Pg 9
WRENCH SETS	Pg 9
HEX KEY SETS	Pg 10
RATCHETS	Pg 10
LOCKING PLIERS	Pg 10
SHIFTERS & WRENCHES	Pg 10

## FASTENING

SOLDERING IRONS	Pg 10
RIVETERS	Pg 10
GLUE GUNS & STICKS	Pg 11
STAPLES & NAILS	Pg 11
STAPLER & STAPLE GUNS	Pg 11
STAPLES - HEAVY DUTY	Pg 11

## PLIERS

SIDE CUTTERS	Pg 12
COMBINATION PLIERS	Pg 12
LONG NOSE PLIERS	Pg 12
CABLE CUTTER	Pg 12
CONCRETE PINNERS	Pg 12
WIRE STRIPPER	Pg 12
SLIP JOINT PLIERS	Pg 12
LINESMAN PLIERS	Pg 13
CIRCLIP PLIERS	Pg 13
GROOVE JOINT PLIERS	Pg 13
MINI PLIERS	Pg 13
3 PIECE PLIER SET	Pg 13
3 PIECE MINI PLIER SET	Pg 13
FENCING PLIER	Pg 13
12 in1 MULTI TOOL	Pg 13

## SCREWDRIVERS & BITS

SCREWDRIVER SETS	Pg 14
SCREWDRIVERS - POZI	Pg 14
SCREWDRIVERS - PHILLIPS	Pg 14
SCREWDRIVER - FATMAX SETS	Pg 15
SCREWDRIVERS - RATCHET	Pg 15

## FINISHING TOOLS

PLANE IRONS	Pg 15
PLANES - BLOCK	Pg 15
PLANES - BENCH	Pg 16
PLANE SPARES - KIT FORM	Pg 16
SURFORM	Pg 17
SURFORM BLADES	Pg 17
SPOKESHAVES & CABINET SCRAPERS	Pg 18

## ELECTRONIC TOOLS

LASER & INTELLI TOOLS	Pg 18
-----------------------	-------

## CHISELS

WOOD CHISELS & SETS	Pg 19
HONING GUIDE, OIL STONE & OIL SET	Pg 19
FATMAX COLD CHISELS & SETS	Pg 19

## MISCELLANEOUS

ABRASIVE TOOLS	Pg 20
AWLS	Pg 20
SCREW HOLE PUNCH	Pg 20
FUBAR FATMAX DEMOLITION	Pg 20
WOOD CARVING SET	Pg 20
DRILL HAND	Pg 20
NAIL SET	Pg 20
WONDER/PRY BAR	Pg 20
FLASHLIGHTS	Pg 21
BENCH VICES	Pg 21
MINI MULTICOLOUR MARKER	Pg 21
TUBE CUTTER	Pg 21
GLASS CUTTER	Pg 21
SCREEN DOOR CLOSER	Pg 21
CORDMATE CABLE CARRIER	Pg 22
CAMPERS AXE	Pg 22
BIT BRACES	Pg 22
SNIPS	Pg 22
HEDGE SHEAR	Pg 22
LAWN & LEAF RAKE	Pg 22

## TOOL BAGS & BOXES

TOOL BAGS & BOXES	Pg 23, 24
-------------------	-----------



The Stanley Works SA

199 Winze Drive, Stormill, Ext 9  
P O Box 148, Florida, 1710

Tel: 011 472 0454 - Fax: 011 472 0482  
Email: [salesrsa@stanleyworks.co.za](mailto:salesrsa@stanleyworks.co.za)

[www.stanleyworks.co.za](http://www.stanleyworks.co.za)



## MEASURING

### TAPE RULES - POWERLOCK - MYLAR COATING

Product #	Description	Pack	Barcode
			
33-218	TAPE RULE POWERLOCK 3M X 13MM METAL CASE	6	076174332186
33-194	TAPE RULE POWERLOCK 5M X 19MM	6	076174331943
33-168	TAPE RULE POWERLOCK 8M X 25MM	6	8850068331682
33-448	TAPE RULE POWERLOCK 10M X 25MM	6	8850068334485

### TAPE RULES - TYLON

Product #	Description	Pack	Barcode
			
30-687	TAPE RULE TYLON 3M X 13MM	6	3253560306878
30-697	TAPE RULE TYLON 5M X 19MM	6	3253560306977
30-657	TAPE RULE TYLON 8M X 25MM	6	3253560306571



### TAPES - DIPPING

Product #	Description	Pack	Barcode
			
2-34-075	BRASS FRAME BLACK ETCHED STEEL BLADE 20M	1	-
2-34-077	BRASS FRAME BLACK ETCHED STEEL BLADE 30M	1	-
2-34-975	TAPE WEIGHT 0,7kg 152,4MM	1	-

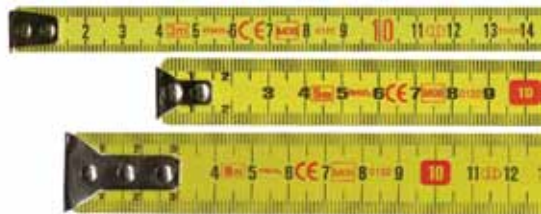
### TAPE RULE - REPLACEMENT BLADES

Product #	Description	Pack	Barcode
			
33-204	REPLACEMENT BLADE 3M	1	-
30-497S	REPLACEMENT BLADE 5M	1	-
30-457S	REPLACEMENT BLADE 8M	1	-
334423	REPLACEMENT BLADE 10M	1	-

### TAPE RULES - LONG



Product #	Description	Pack	Barcode
			
34-105	TAPE RULE 20M X 9.5MM WORKMASTER STEEL BLADE	6	3253560341053
34-108	TAPE RULE 30M X 9.5MM WORKMASTER STEEL BLADE	6	3253560341084
			
34-295	TAPE RULE 10M X 12MM FIBREGLASS CLOSED CASE	6	3253560342951
34-296	TAPE RULE 20M X 12MM FIBREGLASS CLOSED CASE	6	3253560342968
34-297	TAPE RULE 30M X 12MM FIBREGLASS CLOSED CASE	6	3253560342975
34-298	TAPE RULE 50M X 12MM FIBREGLASS CLOSED CASE	6	3253560342982
			
34-792	TAPE RULE 30M X 12MM FIBREGLASS OPEN FRAME	2	3253562347923
34-795	TAPE RULE 60M X 12MM FIBREGLASS OPEN FRAME	2	3253562347954

### TAPE RULES - FATMAX

Product #	Description	Pack	Barcode
			
33-887	TAPE RULE XL FATMAX 5M X 32MM STANDOUT 4M	6	3253561338878
33-892	TAPE RULE XL FATMAX 8M X 32MM STANDOUT 4M	4	3253560338923
33-897	TAPE RULE XL FATMAX 10M X 32MM STANDOUT 4M	4	3253560338978
			
2-34-772	TAPE RULE F/GLASS 30M X 12.7MM P/WINDER 3:1 RATIO	2	3253562347725
2-34-775	TAPE RULE F/GLASS 60M X 12.7MM P/WINDER 3:1 RATIO	2	3253562347756
2-34-777	TAPE RULE F/GLASS 100M X 12.7MM P/WINDER 3:1 RATIO	2	3253562347770

## LAYOUT TOOLS

### LEVELS - BOX & I-BEAM

Product #	Description	Pack	Barcode
			
42-371	LEVEL BOX 460MM 2 VIAL - ALUMINIUM	20	3253561423710
42-389	LEVEL BOX 600MM 2 VIAL - ALUMINIUM	10	3253561423895
42-395	LEVEL BOX 1000MM 2 VIAL - ALUMINIUM	10	3253561423956
42-399	LEVEL BOX 1200MM 2 VIAL - ALUMINIUM	10	3253561423994
			
42-474	LEVEL FOAMCAST ABS 300MM 3 VIAL 1X45°	10	3253561424748
42-475	LEVEL FOAMCAST ABS 450MM 3 VIAL 1X45°	6	3253561424755
42-476	LEVEL FOAMCAST ABS 600MM 3 VIAL 1X45°	6	3253561424762
42-471	LEVEL FOAMCAST ABS 1200MM 3 VIAL 1X45°	6	3253561424717
			
43-625	LEVEL BOX MAG 600MM XTREME 3 VIAL	3	076174436259
43-649	LEVEL BOX MAG 1200MM XTREME 3 VIAL	3	3253565436495

### BEVEL

Product #	Description	Pack	Barcode
			
46-825	BEVEL 203MM HANDYMAN PLASTIC HANDLE	6	076174468250

### PLUMB BOBS

Product #	Description	Pack	Barcode
			
47-971	PLUMB BOB REPLACEMENT TIP	1	-
47-973	PLUMB BOB BRASS 8OZ - 224GR	6	076174479737

### LEVELS - LINE

Product #	Description	Pack	Barcode
			
42-193	LEVEL LINE 75MM PLASTIC	6	076174421934
			
42-287	LEVEL LINE 83MM ALUMINIUM	6	076174422870

### LEVELS - TORPEDO

Product #	Description	Pack	Barcode
			
42-264	LEVEL TORPEDO MAG. BASE JOBMASTER 228MM 3 VIAL	6	076174422641
			
42-291	LEVEL TORPEDO MAG. BASE 203MM 3 VIAL	6	076174422917
			
42-294	LEVEL TORPEDO 203MM 3 VIAL	6	3253560422943
			
43-609	LEVEL TORPEDO MAG 250MM XTREME 3 VIAL	6	3253565436099

### MAGNETIC LEVEL

Features a magnetic base enabling it to be attached to ferrous surfaces, which is ideal when installing machinery or air conditioning ducting.

### SELECTING THE RIGHT LENGTH OF LEVEL

The longer the better, particularly if the surface to be levelled is not perfectly true. A shorter level will tend to follow the contour of the surface, whereas a longer level will even out the undulations.

### MARKING GAUGE

Product #	Description	Pack	Barcode
			
47-064	MARKING GAUGE STYRENE M/E	5	076174470642



SQUARES			
Product #	Description	Pack	Barcode
			
45-530	SQUARE METRIC RAFTER STEEL 600 X 400MM	6	076174455304
			
46-060	SQUARE METRIC RAFTER PLASTIC 80 X 260MM	6	076174460605
			
46-506	SQUARE TRY / MITRE 150MM STEEL	10	747752465069
46-508	SQUARE TRY / MITRE 200MM STEEL	10	747752465083
46-510	SQUARE TRY / MITRE 250MM STEEL	10	747752465106
46-512	SQUARE TRY / MITRE 300MM STEEL	10	747752465120
			
46-513	SQUARE TRY / MITRE 200MM PLASTIC	10	747752465137
46-514	SQUARE TRY / MITRE 250MM PLASTIC	10	747752465144
46-515	SQUARE TRY / MITRE 300MM PLASTIC	10	747752465151
			
2-46-017	SQUARE COMBINATION 300MM PLASTIC	6	3253562460172
2-46-143	SQUARE COMBINATION 300MM STEEL	3	3253562461438
1-46-998	SQUARE REPAIR KIT FOR 2-46-143	1	-

CHALK REELS & CHALK			
Product #	Description	Pack	Barcode
			
47-099	CHALK REEL 30M METAL CASE	2	076174470994
47-101	CHALK REEL REPLACEMENT LINE 30M	6	076174471014
			
47-440	CHALK REEL 30M PLASTIC CASE	6	076174474404
			
1-47-403	CHALK REFILL BLUE 115G	12	3253561474033
1-47-404	CHALK REFILL RED 115G	12	3253561474040
			
47-442	CHALK REEL 30M PLASTIC CASE + CHALK REFILL BLUE	5	076174474428
			
47-480	CHALK REEL FATMAX XTREME 30M - 5 x REWIND	6	076174474800
			
47-482	CHALK REEL XTREME + BLUE CHALK - 5 x REWIND	6	076174474824
			
47-681	CHALK REEL + CHALK + MARKER FATMAX - 3 x REWIND	5	076174476811

# KNIVES & BLADES

KNIVES			
Product #	Description	Pack	Barcode
			
0-10-239	KNIFE MITEY + 2 BLADES METAL	12	076174100396
			
10-189	KNIFE SELF RETRACTING + 1 BLADE	12	076174101898
			
10-299	KNIFE INTERLOCK + 1 BLADE	6	076174102994
			
10-480	KNIFE SNAP-OFF BLADE 18MM CARTRIDGE + 6 BLADES	6	076174104806
			
10-810	KNIFE SLIDING POCKET UTILITY + 1 BLADE	6	076174108101
			
10-813	KNIFE QUICK SLIDE SPORT 2 IN 1	2	076174108132
			
0-10-010	KNIFE HEAVY DUTY INTERLOCK + 3 BLADES	12	3253560100100
			
2-10-550	TITAN FIXED + 3 BLADES	12	3253562105509
			
0-10-170	TITAN SHEATH FOR 2-10-550	12	3253560101701
			
0-10-018	KNIFE SNAP-OFF BL 18MM INTERLOCK + 1 BLADE	12	3253560100186

KNIVES CONTINUED			
Product #	Description	Pack	Barcode
			
0-10-020	KNIFE H/DUTY INTERLOCK RETR + 3 BLADES	12	3253560100209
			
0-10-088	KNIFE RETRACTABLE PLASTIC + 1 BLADE	12	3253560100889
			
0-10-150	KNIFE SNAP-OFF BLADE 9.5MM + 1 BLADE	12	3253560101503
0-10-151	KNIFE SNAP-OFF BLADE 18MM + 1 BLADE	12	3253560101510
			
0-10-590	KNIFE SLIM + 3 BLADES	12	5000366105901
			
0-10-598	KNIFE POCKET FOLDING + 3 BLADES	12	5000366105987
			
0-10-601	KNIFE MODEL 3 PER PACKET	12	3253560106010
1-10-601	KNIFE MODEL BOX OF 50	1	3253561106016
			
0-10-788	KNIFE INSTANT FRONT LOAD RETRACTABLE + 3 BLADES	6	076174107883
			
0-10-855	FOLDING UTILITY KNIFE + 1 BLADE	4	3253560108557
			
0-10-825	FATMAX FOLDING RETRACTABLE KNIFE	1	3253560108250

**KNIVES CONTINUED**

Product #	Description	Pack	Barcode
			
2-10-099	RETRACTABLE + 3 BLADES	12	3253562100993
			
2-10-199	TRIMMING CARPET + 3 BLADES	12	5000366101996
			
0-10-780	FATMAX FIXED BLADE KNIFE + 5 BLADES	6	3253560107802
0-10-778	FATMAX KNIFE RETRACTABLE	6	3253560107789
			
0-10-789	FATMAX EXTREME TWIN BLADE KNIFE	6	3253560107895

**BLADES**

Product #	Description	Pack	Barcode
			
2-11-987	ROUNDED END BLADES X10	10	3253562119872
			
1-11-221	KNIFE BLADES 1X50 for 10-590/598 STR	1	3253561112218
0-11-221	KNIFE BLADES 1X3 for 10-590 / 598 STR	10	3253560112219
			
1992-20	KNIFE BLADES HEAVY DUTY 1 X 20 CARDED	20	6002154199221
1-11-921	KNIFE BLADES HEAVY DUTY 100 PACK	1	3253561119217
0-11-921	KNIFE BLADES HEAVY DUTY 1 X 5 CARDED	10	5000366119212
4-11-921	KNIFE BLADES 400 BULK IN 100'S	1	-
11-921T	KNIFE BLADES HEAVY DUTY 1X10 CARTRIDGE	12	076174119213
			
1-11-916	KNIFE BLADES 1992N 100 PACK 4 HOLES	1	3253561119163

**BLADES CONTINUED**

Product #	Description	Pack	Barcode
			
1-11-911	KNIFE BLADES NORMAL DUTY 100 PACK	1	3253561119118
0-11-911	KNIFE BLADES NORMAL DUTY 1 X 5 CARDED	10	5000366119113
			
1-11-983	KNIFE BLADES HOOKED 100 SHARP POINT	1	3253561119835
0-11-983	KNIFE BLADES HOOKED 1X5 CARDED	10	5000366119618
			
11-031	KNIFE BLADES 1 X 3 for 10-039 AND 10-239	10	076174110319
			
11-931A	KNIFE BLADES EXTRA HEAVY DUTY 100 PACK	1	076174119312
11-931	KNIFE BLADES EXTRA HEAVY DUTY 1 X 5 CARDED	10	076174004939
			
0-11-300	KNIFE BLADES SNAP-OFF 9,5MM 1X10 for 0-10-150	10	3253560113001
			
0-11-301	KNIFE BLADES SNAP-OFF 18MM 1X10 for 10-151/480/018	10	3253560113018

**DECORATORS TOOLS**

**SCRAPERS**

Product #	Description	Pack	Barcode
			
28-500	SCRAPER RAZOR BLADE	10	076174285000
28-510	SCRAPER BLADES FOR 28-500 10 PER CARD	10	076174285109
			
0-28-590	SCRAPER WINDOW	12	5000366105932



## DECORATORS TOOLS CONTINUED

### PUTTY KNIVES

Product #	Description	Pack	Barcode
			
28-080	PUTTY KNIFE 38MM	12	747752280808
28-081	PUTTY KNIFE 50MM	12	747752280815
28-082	PUTTY KNIFE 63MM	12	747752280822
28-083	PUTTY KNIFE 75MM	12	747752280839
28-084	PUTTY KNIFE 100MM	12	747752280846





## SAWS

### SAWS - CROSSCUT, JET, RIP, PANEL & BACK

Product #	Description	Pack	Barcode
			
20-503	SAW X-CUT HANDYMAN 510MM WOOD HANDLE	12	8887329205031
20-504	SAW X-CUT HANDYMAN 550MM WOOD HANDLE	12	8887329205048
20-505	SAW X-CUT HANDYMAN 610MM WOOD HANDLE	12	8887329205055
			
15-559	SAW X-CUT 510MM X 8PT PROFESSIONAL	10	747752155595
15-560	SAW X-CUT 550MM X 8PT PROFESSIONAL	10	747752155601
15-561	SAW X-CUT 610MM X 8PT PROFESSIONAL	10	747752155618
15-562	SAW X-CUT 660MM X 8PT PROFESSIONAL	10	747752155625
20-515	SAW RIP 660MM X 5PT PROFESSIONAL	10	747752205153
			
2-15-288	SAW JET CUT 500MM X 8PT HARDPOINT	6	3253562152886
2-15-289	SAW JET CUT 560MM X 8PT HARDPOINT	6	3253562152893
2-15-241	SAW JET CUT 600MM X 8PT HARDPOINT	6	3253562152411
2-15-599	SAW JET CUT PANEL 500MM X 12PT HARDPOINT	6	3253562155993
			
15-884	SAW BACK 305MM X 13PT PROFESSIONAL	10	747752158848
15-886	SAW BACK 356MM X 13PT PROFESSIONAL	10	747752158862

### SAWS OTHER

Product #	Description	Pack	Barcode
			
0-20-108	FATMAX 5 IN 1 HACKSAW HEAVY DUTY 300MM	6	3253560201081
			
15-166	SAW HACK PROFESSIONAL 300MM	6	4711815151660
			
15-200	SAW HACK CHROME 300MM ADJUSTABLE FRAME	12	747752152006
			
20-206	SAW HACK FIXED FRAME 300MM	12	747752202060
			
15-904A	SAW HACK BLD 24T 250MM CARBON - 2 PER CARD	10	076174159912
15-924A	SAW HACK BLD 24T 300MM CARBON - 2 PER CARD	10	076174159943
15-928A	SAW HACK BLD 18T 300MM CARBON - 2 PER CARD	10	076174159950
			
15-521	SAW MINI HACK HEAVY DUTY	10	747752155212
			
0-20-807	SAW MINI HACK NORMAL DUTY	6	3253560208073

SAWS - OTHER CONTINUED			
Product #	Description	Pack	Barcode
			
0-15-218	SAW HACK JNR QUICK RELEASE + 1 BLADE	10	3253560152185
			
3-15-905	SAW BLADE JUNIOR HACKSAW 5 BLADES	10	3253563159051
			
15-275	SAW KEYHOLE 2 BLADE	6	076174152753
			
0-20-092	SAW SET 3 IN 1	2	3253560200923
			
1-20-447	SAW HACK/BOW 2 IN 1 300MM	12	3253561204470
1-20-437	SAW BLADE BOW 300MM	1	3253561204371
			
15-675	SAW PRUNING 300MM	10	747752156752
			
15-106A	SAW COPING 160MM X 170MM + 3 BLADES	6	076174000061
15-058	SAW BLADE COPING 10T 4 PER CARD	10	076174150582
15-059	SAW BLADE COPING 20T 4 PER CARD	10	076174150599
15-061	SAW BLADE COPING 16T 4 PER CARD	10	076174150612

MITRE BOXES			
Product #	Description	Pack	Barcode
			
19-212	MITRE BOX SAW STORAGE - PLASTIC	8	076174192124
			
19-800	MITRE BOX SAW STORAGE + SAW - PLASTIC	8	076174198003
			
20-112	MITRE BOX CLAMPING - PLASTIC	6	076174201123
			
20-600	MITRE BOX CLAMPING + SAW - PLASTIC	6	076174206005
			
20-800	MITRE BOX CLAMPING + SAW - METAL	1	076174208009
20-800-4	SPARE BLADE WOOD FOR 20-800 MITRE BOX	1	-



## HAMMERS

### HAMMERS - BALL PEIN

Product #	Description	Pack	Barcode
			
54-189	HAMMER BALL PEIN 230GR WOOD HANDLE - HICKORY	6	747752541893
54-190	HAMMER BALL PEIN 340GR WOOD HANDLE - HICKORY	6	747752541909
54-191	HAMMER BALL PEIN 450GR WOOD HANDLE - HICKORY	6	747752541916
54-192	HAMMER BALL PEIN 680GR WOOD HANDLE - HICKORY	6	747752541923
54-193	HAMMER BALL PEIN 910GR WOOD HANDLE - HICKORY	6	747752541930

### HAMMERS - DRILLING

Product #	Description	Pack	Barcode
			
56-705	DRILLING HAMMER 1400G FIBREGLASS HANDLE	4	076174567052

### HAMMERS - CLUB & MALLET

Product #	Description	Pack	Barcode
			
56-399	HAMMER CLUB 1000GR WOOD HANDLE	6	747752563994
56-401	HAMMER CLUB 2000GR WOOD HANDLE	4	747752564014
			
57-528	RUBBER MALLET 610GR WOOD HANDLE	6	4711815575282

### HAMMERS - ENGINEERS

Product #	Description	Pack	Barcode
			
56-202	ENGINEERS HAMMER 1100G FIBREGLASS HANDLE	4	076174562026
56-204	ENGINEERS HAMMER 2000G FIBREGLASS HANDLE	4	076174562040

### HAMMERS - CLAW

Product #	Description	Pack	Barcode
			
1-51-505	HAMMER CLAW 450G GRAPHITE HANDLE	4	3253561515057
1-51-507	HAMMER CLAW 540G GRAPHITE HANDLE	4	3253561515071
			
51-071	HAMMER CLAW 450G FIBREGLASS HANDLE	6	747752510714
51-072	HAMMER CLAW 570G FIBREGLASS HANDLE	6	747752510721
			
51-081	HAMMER CLAW 450G TUBULAR STEEL HANDLE	6	747752510813
51-082	HAMMER CLAW 570G TUBULAR STEEL HANDLE	6	747752510820
			
51-271	HAMMER CLAW 450G WOOD HANDLE	6	747752512718
51-274	HAMMER CLAW 570G WOOD HANDLE	6	747752512749
			
51-162	HAMMER CLAW XTREME 450G PROFESSIONAL	4	076174511628
51-164	HAMMER CLAW XTREME 570G PROFESSIONAL	4	076174511642

### CLUB & DRILLING HAMMERS

This should be your only choice if you intend to strike a cold chisel. The striking face of the striking tool must be larger than the chisel to be struck otherwise there is a serious risk of injury from flying metal splinters, particularly if the chisel has been allowed to mushroom too much.

**MECHANICS TOOLS**

**SOCKET & SPANNER SETS**

Product #	Description	Pack	Barcode
			
1-87-025	SOCKET SET 21 PIECE 6MM 1/4" DRIVE	1	3253561870255
			
1-94-672	"EXPERT" SOCKET SET 35 PIECE 6MM 1/4" DRIVE	1	3253561946721
			
1-94-673	"EXPERT" SOCKET SET 20 PIECE 10MM 3/8" DRIVE	1	3253561946738
			
1-86-789	"EXPERT" SOCKET SET 52 PIECE 13MM 1/2" & 6MM 1/4" DRIVE	1	3253561867897
			
1-94-670	"EXPERT" SOCKET SET 72 PIECE 13MM 1/2" DRIVE	1	3253561946707
			
1-94-669	"EXPERT" SOCKET SET 77 PIECE 13MM 1/2" & 6MM 1/4" DRIVE	1	3253561946691

**SOCKETS - PP HANGER - 13MM 1/2" DRIVE**

Product #	Description	Pack	Barcode
			
1-86-540	SOCKET 8MM X 12PT	6	6002154865409
1-86-541	SOCKET 9MM X 12PT	6	6002154865416
1-86-542	SOCKET 10MM X 12PT	6	6002154865423
1-86-543	SOCKET 11MM X 12PT	6	6002154865430
1-86-544	SOCKET 12MM X 12PT	6	3253564865449
1-86-545	SOCKET 13MM X 12PT	6	6002154865454
1-86-546	SOCKET 14MM X 12PT	6	3253564865463
1-86-547	SOCKET 15MM X 12PT	6	6002154865478
1-88-788	SOCKET 16MM X 12PT	6	6002154887883
1-88-789	SOCKET 17MM X 12PT	6	3253564887892
1-88-790	SOCKET 18MM X 12PT	6	6002154887906
1-88-791	SOCKET 19MM X 12PT	6	3253564887915

**SPANNERS**

Product #	Description	Pack	Barcode
			
4-86-851	COMBINATION SPANNER 6MM - PP HANGER	10	3253564868518
4-86-852	COMBINATION SPANNER 7MM - PP HANGER	10	3253564868525
4-86-853	COMBINATION SPANNER 8MM - PP HANGER	10	3253564868532
4-86-854	COMBINATION SPANNER 9MM - PP HANGER	10	3253564868549
4-86-855	COMBINATION SPANNER 10MM - PP HANGER	10	3253564868556
4-86-856	COMBINATION SPANNER 11MM - PP HANGER	10	3253564868563
4-86-857	COMBINATION SPANNER 12MM - PP HANGER	10	3253564868570
4-86-858	COMBINATION SPANNER 13MM - PP HANGER	10	3253564868587
4-86-859	COMBINATION SPANNER 14MM - PP HANGER	10	3253564868594
4-86-860	COMBINATION SPANNER 15MM - PP HANGER	10	3253564868600
4-86-861	COMBINATION SPANNER 16MM - PP HANGER	10	3253564868617
4-86-862	COMBINATION SPANNER 17MM - PP HANGER	10	3253564868624
4-86-863	COMBINATION SPANNER 18MM - PP HANGER	10	3253564868631
4-86-864	COMBINATION SPANNER 19MM - PP HANGER	10	3253564868648
1-86-865	COMBINATION SPANNER 20MM - -PP HANGER	4	6002154868653
1-86-866	COMBINATION SPANNER 21MM - -PP HANGER	4	6002154868660
1-86-867	COMBINATION SPANNER 22MM - -PP HANGER	4	6002154868677
1-86-869	COMBINATION SPANNER 24MM - -PP HANGER	4	6002154868691

**WRENCH SETS**

4-86-850	WRENCH SET 8PC COMB 8, 10- 14, 17, 19mm	1	6002154868509
4-86-870	WRENCH SET 12PC COMB 6-14, 17, 19, 22mm	1	6002154868707

**STANLEY MAKE SOMETHING GREAT™**

**STANLEY**



## MECHANICS TOOLS CONTINUED

### HEX KEY SETS

Product #	Description	Pack	Barcode
			
0-69-251	HEX KEY 8 PIECE SET 1,5 - 6MM	12	747752692519
0-69-256	HEX KEY BALL 9 PIECE SET 1,5 - 10MM	6	747752692564
0-69-257	HEX KEY 12 PIECE SET - IMPERIAL	6	3253560692575
			
4-69-262	HEX KEY FOLDING 7 PIECE SET 2,5 - 10MM	12	747752692625
4-69-263	HEX KEY TORX FOLDING 8 PIECE SET T9-T40	12	747752692632
4-69-261	HEX KEY FOLDING 7 PIECE SET 1.5-6MM	12	747752692618

### RATCHETS - BI MATERIAL HANDLES

Product #	Description	Pack	Barcode
			
1-13-770	1/4" RATCHET 6MM	1	3253561137709
1-13-848	3/8" RATCHET 10MM	1	3253561138485
1-13-708	1/2" RATCHET 13MM	1	3253561137082

### LOCKING PLIERS

Product #	Description	Pack	Barcode
			
84-368	PLIER LOCKING CURVED 180MM	6	747752843683
84-369	PLIER LOCKING CURVED 250MM	6	747752843690
			
84-370	PLIER LOCKING STRAIGHT 180MM	6	747752843706
84-371	PLIER LOCKING STRAIGHT 250MM	6	747752843713

### SHIFTERS & WRENCHES

			
87-448	BASIN WRENCH	10	747752874489

### SHIFTERS & WRENCHES CONTINUED

Product #	Description	Pack	Barcode
			
0-90-947	WRENCH ADJ SHIFTER 150MM	2	3253560909475
0-90-948	WRENCH ADJ SHIFTER 200MM	2	3253560909482
0-90-949	WRENCH ADJ SHIFTER 250MM	2	3253560909499
0-90-950	WRENCH ADJ SHIFTER 300MM	2	3253560909505
			
87-622	PIPE WRENCH 241MM	6	4711815876228
87-623	PIPE WRENCH 295MM	6	4711815876235
87-624	PIPE WRENCH 330MM	6	4711815876242
87-625	PIPE WRENCH 405MM	2	4711815876259
87-626	PIPE WRENCH 550MM	1	4711815876266

## FASTENING

### SOLDERING IRONS

Product #	Description	Pack	Barcode
			
69-031	SOLDER IRON 30 WATT SABS APP	20	4711815690312
69-033	SOLDER IRON 45 WATT SABS APP - 2 TIPS	20	4711815690336
ST45	TIP CHISEL FOR 69-033	1	-
ST55	TIP ROUND FOR 69-033	1	-

### RIVETERS

Product #	Description	Pack	Barcode
			
69-646	RIVETER LIGHT DUTY 3 NOZZLE	5	747752696463
			
69-799	RIVETER HEAVY DUTY 4 NOZZLE	6	4711815697991
69-799J	JAWS FOR RIVETER	1	-
			
69-800	RIVETER HEAVY DUTY 4 NOZZLE CONCERTINA	1	6002154698007

GLUE GUNS & STICKS			
Product #	Description	Pack	Barcode
			
0-GS10DT	GLUE MINI 4" 24 PACK FOR 69-028	5	045731063665
GS300	1KG BULK GLUE STICKS 32 PACK FOR 69-665 & GR100	1	3253560052126
GS230	GLUE ALL PURPOSE CLEAR 4" 6 PACK FOR 69-665 & GR100	5	045731028121
GS260	GLUE WOODWORKING 4" 6 PACK FOR 69-665 & GR100	5	045731041243
GS500	GLUE SUPER STRENGTH 4" 6 PACK FOR 69-665 & GR100	5	045731060022



**INCLUDES**  
3x GLUE STICKS

69-028	GLUE GUN MINI TRIGGER L/D SABS APP 12w	10	4711815690282
--------	--	----	---------------



**INCLUDES**  
3x GLUE STICKS

69-665	GLUE GUN TRIGGER FEED H/D SABS APP 40w	12	4711815696659
--------	--	----	---------------



**INCLUDES**  
2x NOZZLES  
18x GLUE STICKS

GR100	GLUE GUN PROFESSIONAL H/D SABS APP 80w	5	045731132385
-------	--	---	--------------

**STAPLES & NAILS**

Product #	Description	Pack	Barcode
			

TRA204T	STAPLE 6MM 1000 TR45 / 69-721	7	076174053883
TRA205T	STAPLE 8MM 1000 TR45 / 69-721	6	076174053890
TRA206T	STAPLE 10MM 1000 TR45 / 69-701/702/721	5	3253561054105
TRA208T	STAPLE 12MM 1000 69-701 / 702 / 721	4	3253561055140
TRA209T	STAPLE 14MM 1000 69-701/ 702 / 721	4	3253561055195

STAPLES & NAILS			
Product #	Description	Pack	Barcode
			
TRA704T	STAPLE 6MM 1000 TR100 / TR150 / TR250	7	076174054194
TRA705T	STAPLE 8MM 1000 TR100 / TR150 / TR250	6	076174054279
TRA706T	STAPLE 10MM 1000 TR100 / TR150 / TR250	5	076174054286
TRA708T	STAPLE 12MM 1000 TR100 / TR150 / TR250	4	076174054293
TRA709T	STAPLE 14MM 1000 TR100 / TR150 / TR250	4	076174054309

			
SWKBN 050	BRADS 12MM 1000 TR250 / 69-702 / 721	5	077914038719
SWKBN 625	BRADS 16MM 1000 TR250 / 69-702 / 721	5	077914038283

**STAPLER & STAPLE GUNS**

Product #	Description	Pack	Barcode
			
TR45	STAPLE GUN LIGHT DUTY SHARPSHOOTER	5	045731131470

			
TR250	STAPLE GUN/BRAD NAILER/ CABLE TACKER HEAVY DUTY	6	076174050073

			
02245	STAPLING PLIER B8	6	077914022459

**STAPLES - HEAVY DUTY**

Product #	Description	Pack	Barcode
			
STCR 2115-1/4	6MM STAPLES - 5000 / BOX FOR 02245 B8 - 1/4	25	077914007180
STCR 2115-3/8	10MM STAPLES - 5000 / BOX FOR 02245 B8 - 3/8	20	077914007227



**PLIERS**

**FATMAX SIDE CUTTERS**

Product #	Description	Pack	Barcode
			
0-89-858	FATMAX SIDE CUTTER 150MM	4	3253560898588
0-89-859	FATMAX SIDE CUTTER 190MM	4	3253560898595
0-89-861	FATMAX SIDE CUTTER 200MM	4	3253560898618

**FATMAX COMBINATION PLIERS**

Product #	Description	Pack	Barcode
			
0-89-867	FATMAX COMBINATION PLIER 180MM	4	3253560898670
0-89-868	FATMAX COMBINATION PLIER 200MM	4	3253560898687

**FATMAX LONG NOSE PLIERS**

Product #	Description	Pack	Barcode
			
0-89-869	FATMAX LONG NOSE PLIER 150MM	4	3253560898694
0-89-870	FATMAX LONG NOSE PLIER 200MM	4	3253560898700

**FATMAX CABLE CUTTER**

Product #	Description	Pack	Barcode
			
0-89-874	FATMAX CABLE CUTTER 215MM	4	3253560898748

**CONCRETE PINCERS**

Product #	Description	Pack	Barcode
			
2-84-181	PINCERS CONCRETE 250MM	6	3253562841810

**WIRE STRIPPER**

Product #	Description	Pack	Barcode
			
84-214	WIRE STRIPPER	6	8887329842144

**SLIP JOINT PLIERS**

Product #	Description	Pack	Barcode
			
84-097	PLIER SLIP JOINT 150MM	6	3253560840976

**FATMAX SLIP JOINT PLIER**

Product #	Description	Pack	Barcode
			
0-84-646	FATMAX SLIP JOINT PLIER PUSHLOCK 200MM	4	3253560846466

**LONG NOSE PLIERS**

Product #	Description	Pack	Barcode
			
84-053	PLIER LONG NOSE 150MM HEAVY DUTY	12	3253560840532
84-625	PLIER LONG NOSE 200MM HEAVY DUTY	12	3253560846251
			
84-100	PLIER LONG NOSE 125MM	6	3253560841003
84-101	PLIER LONG NOSE 150MM	6	3253560841010
84-102	PLIER LONG NOSE 200MM	6	3253560841027

**SIDE CUTTERS**

Product #	Description	Pack	Barcode
			
84-054	SIDE CUTTER 150MM HEAVY DUTY	12	3253560840549
84-622	SIDE CUTTER 180MM HEAVY DUTY	12	3253560846220
			
84-104	SIDE CUTTER 125MM	6	3253560841041
84-105	SIDE CUTTER 150MM	6	3253560841058
84-108	SIDE CUTTER 180MM	6	3253560841089

STANLEY MAKE SOMETHING GREAT™

**STANLEY**

LINESMAN PLIERS			
Product #	Description	Pack	Barcode
			
84-623	PLIER LINESMAN 150MM HEAVY DUTY	12	3253560846237
84-055	PLIER LINESMAN 180MM HEAVY DUTY	12	3253560840556
84-056	PLIER LINESMAN 200MM HEAVY DUTY	12	3253560840563

			
84-154	PLIER LINESMAN 228MM PROFESSIONAL	12	747752841542
			
84-112	PLIER LINESMAN 180MM	6	3253560841126
84-113	PLIER LINESMAN 200MM	6	3253560841133

CIRCLIP PLIERS			
Product #	Description	Pack	Barcode
			
84-271	CIRCLIP PLIER - STRAIGHT EXTERNAL	6	747752842716
84-273	CIRCLIP PLIER - STRAIGHT INTERNAL	6	747752842730
84-272	CIRCLIP PLIER - BENT EXTERNAL	6	747752842723
84-274	CIRCLIP PLIER - BENT INTERNAL	6	747752842747

GROOVE JOINT PLIERS			
Product #	Description	Pack	Barcode
			
84-109	PLIER GROOVE JOINT 200MM	6	3253560841096
84-110	PLIER GROOVE JOINT 250MM	6	3253560841102
84-111	PLIER GROOVE JOINT 300MM	6	3253560841119

FATMAX GROOVE JOINT PLIERS			
Product #	Description	Pack	Barcode
 <b>STANLEY</b> <b>FatMax</b>			
0-84-647	FATMAX GROOVE JOINT PLIER PUSHLOCK 200MM	4	3253560846473
0-84-648	FATMAX GROOVE JOINT PLIER PUSHLOCK 250MM	4	3253560846480
0-84-649	FATMAX GROOVE JOINT PLIER PUSHLOCK 300MM	4	3253560846497

MINI PLIERS			
Product #	Description	Pack	Barcode
			
84-096	MINI NEEDLE NOSE PLIER 125MM	6	3253560840969
84-119	MINI LONG NOSE PLIER 100MM	6	3253560841195
84-122	MINI FLAT NOSE PLIER 100MM	6	3253560841225
84-124	MINI SIDE CUTTER 100MM	6	3253560841249
84-125	MINI END NIPPER 100MM	6	3253560841256
84-126	MINI BENT NOSE PLIER 125MM	6	3253560841263

3 PIECE PLIER SET			
Product #	Description	Pack	Barcode
			
90-162	PLIER SET 3P, S/CUTTER, L/NOSE, COMBINATION	6	747752901628

3 PIECE MINI PLIER SET			
Product #	Description	Pack	Barcode
			
90-155	MINI PLIER SET 3P S/CUTTER, L/NOSE, N/NOSE	4	747752901550

FENCING PLIER			
Product #	Description	Pack	Barcode
			
84-817	FENCING PLIER 250MM	5	6002154011295

12 IN 1 MULTI TOOL			
Product #	Description	Pack	Barcode
			
0-84-519	12 IN 1 MULTI TOOL	5	3253560845193



# SCREWDRIVERS & BITS

## SCREWDRIVER SETS

Product #	Description	Pack	Barcode
			
60-220	SCREWDRIVER SET 20 PIECE BLISTER	4	076174602203

			
64 P6	SCREWDRIVER 6PC WALLET GLOBAL	12	6002154640068

			
65-750	SCREWDRIVER 14 PIECE MECHANIC PROFESSIONAL	10	9300691657509

			
66-039	SCREWDRIVER 6PC PRECISION	6	076174660395

			
66-052	S/DRIVER 6PC PRECISION BI-MATERIAL	12	8887329660526

			
0-63-038	SCREWDRIVER 38PC BIT & SOCKET SET	2	3253560630386

## SCREWDRIVER SETS CONTINUED

Product #	Description	Pack	Barcode
			
60-060	SCREWDRIVER 6PC WALLRACK GLOBAL	6	076174600605

			
0-65-242	SCREWDRIVER 6PC CUSHION GRIP 2 X PHILL PROF	6	3253560652425
1-65-244	SCREWDRIVER 4PC CUSHION GRIP 2 X PHILL PROF	6	3253561652448

0-65-242	SCREWDRIVER 6PC CUSHION GRIP 2 X PHILL PROF	6	3253560652425
1-65-244	SCREWDRIVER 4PC CUSHION GRIP 2 X PHILL PROF	6	3253561652448

## SCREWDRIVERS - POZI

Product #	Description	Pack	Barcode
			
0-64-952	POZIDRIV S/D 0PT 60MM CUSHION GRIP - CARDED	6	3253560649524
0-64-955	POZIDRIV S/D 1PT 75MM CUSHION GRIP - CARDED	6	3253560649555
0-64-974	POZIDRIV S/D 2PT 100MM CUSHION GRIP - CARDED	6	3253560649746
0-64-976	POZIDRIV S/D 3PT 150MM CUSHION GRIP - CARDED	6	3253560649760

			
--	--	--	--

## SCREWDRIVERS - PHILLIPS



Product #	Description	Pack	Barcode
0-64-930	PHILLIPS S/D 0PT 60MM CUSHION GRIP - CARDED	6	3253560649302
0-64-932	PHILLIPS S/D 1PT 75MM CUSHION GRIP - CARDED	6	3253560649326
0-64-933	PHILLIPS S/D 1PT 150MM CUSHION GRIP - CARDED	6	3253560649333
0-64-940	PHILLIPS S/D 2PT 100MM CUSHION GRIP - CARDED	6	3253560649401
0-64-941	PHILLIPS S/D 2PT 150MM CUSHION GRIP - CARDED	6	3253560649418
0-64-949	PHILLIPS S/D 3PT 150MM CUSHION GRIP - CARDED	6	3253560649494

FATMAX SCREWDRIVER SETS			
Product #	Description	Pack	Barcode
			
0-65-440	FATMAX 5P PARRALLEL/PHILLIPS S/DRIVER SET	4	3253560654405

			
0-65-441	FATMAX S/DRIVER SET 6P 1000 VDE	1	3253560654412

SCREWDRIVERS - RATCHET			
			
0-69-191	XTREME MULTIBIT RATCHET S/DRIVER SET	1	3253560691912

			
1-13-905	"EXPERT" 32P BIT & RATCHET SET	10	3253561139055

SCREWDRIVERS - RATCHET CONTINUED			
Product #	Description	Pack	Barcode
			
0-68-010	MULTIBIT RATCHET SCREWDRIVER + 10 BITS	6	3253560680107
			
3-68-131	YANKEE SPIRAL RATCHET 714MM	1	5000366681313

**FINISHING TOOLS**

PLANES & IRONS			
			
0-12-134	CUTTER FOR 12-034 & 12-121	6	3253560121341
1-12-323	CUTTER DOUBLE FOR 4 & 5 PLANE 50MM	6	-
1-12-325	CUTTER DOUBLE FOR 4 1/2, 6 & 7 PLANE 60MM	6	-
0-12-312	CUTTER FOR 3 PLANE CARDED 45MM	6	3253560123123
0-12-313	CUTTER FOR 4 & 5 PLANE CARDED 50MM	6	3253560123130
0-12-315	CUTTER FOR 4 1/2, 6 & 7 PLANE CARDED 60MM	6	3253560123154
0-12-504	CUTTER FOR 12-060 PLANE	6	076174125047
0-12-508	CUTTER FOR 12-020 / 220 PLANE 3 SLOTS NEW	6	076174125085
1-12-312	CUTTER FOR 3 PLANE 45MM - BULK	6	-
1-12-313	CUTTER FOR 4 & 5 PLANE 50MM - BULK	6	-
1-12-315	CUTTER FOR 4 1/2, 6 & 7 PLANE 60MM - BULK	6	-
1-12-333	CUTTER FOR 12-078 PLANE	6	-

PLANES - BLOCK			
Product #	Description	Pack	Barcode
			
1-12-020	PLANE ADJ BLOCK 160X40MM 21°	1	076174120202



## FINISHING TOOLS CONTINUED

### PLANES - BLOCK CONTINUED

Product #	Description	Pack	Barcode
			
1-12-060	PLANE ADJ BLOCK LOW ANGLE 150X35MM 13.5°	1	076174120608
			
1-12-078	PLANE DUPLEX REBATE 255X38MM	1	076174120780
			
1-12-101	PLANE MODELMAKER 90X25MM	1	076174121018
			
1-12-102	PLANE BLOCK NON-ADJUSTABLE 140X35MM	1	076174121025
1-12-116	PLANE BLOCK NON-ADJUSTABLE 180X40MM	1	076174121162
			
1-12-220	PLANE BLOCK ADJUSTABLE 180X40MM	1	076174122206

### PLANES - BENCH

Product #	Description	Pack	Barcode
			
1-12-203	PLANE HANDYMAN SMOOTH 240X45MM	1	5000366122038
1-12-204	PLANE HANDYMAN SMOOTH 245X50MM	1	5000366122045
1-12-205	PLANE HANDYMAN JACK 355X50MM	1	5000366122052

### PLANES - BENCH CONTINUED



Product #	Description	Pack	Barcode
			
12-212	PLANE HOBBY STAR NO 4	1	747752122122
1-12-034	PLANE SMOOTH 245X50MM	1	076174120349
			
12-163	PLANE GLOBAL 235 X 45MM	1	076174121636
12-164	PLANE GLOBAL 245 X 50MM	1	076174121643
12-165	PLANE GLOBAL 355 X 50MM	1	076174121650
			
1-12-003	PLANE BAILEY SMOOTH 240X45MM	1	5000366120034
1-12-004	PLANE BAILEY SMOOTH 245X50MM	1	5000366120041
1-12-005	PLANE BAILEY JACK 355X50MM	1	5000366120058
1-12-045	PLANE BAILEY SMOOTH 260X60MM	1	076174120455
1-12-006	PLANE BAILEY FORE 460X60MM	1	076174120066
1-12-007	PLANE BAILEY JOINTER/TRY 560X60MM	1	076174120073

### PLANE SPARES - KIT FORM

Product #	Description	Pack	Barcode
1-12-700	KIT 1 - HANDLE / KNOB / SCREWS FOR 3 & 4 PLANES	1	-
1-12-701	KIT 2 - HANDLE / KNOB / SCREWS FOR 4.5, 5, 5.5, 6 & 7 PLANES	1	-
1-12-702	KIT 3 - SCREWS & NUTS FOR BAILEY & HANDYMAN PLANES	1	-
1-12-703	KIT 4 - FROG COMPLETE FOR NO 3 PLANES	1	-
1-12-704	KIT 5 - FROG COMPLETE FOR 4 & 5 PLANES	1	-
1-12-705	KIT 6 - FROG COMPLETE FOR 4.5, 5.5, 6 & 7 PLANES	1	-
1-12-706	KIT 7 - LEVER & SCREW FOR NO 3 PLANES	1	-
1-12-707	KIT 8 - LEVER & SCREW FOR 4 & 5 PLANES	1	-
1-12-708	KIT 9 - LEVER & SCREW FOR 12-045, 055, 007 & 006 PLANES	1	-
1-12-709	KIT 10 - CUTTER, LEVER, KNOB & SCREW FOR 020 & 220 PLANES	1	-

PLANE SPARES - KIT FORM CONTINUED			
Product #	Description	Pack	Barcode
1-12-710	KIT 11 - LEVER & SCREW FOR 020 & 220 PLANES	1	-
1-12-713	KIT 14 - LEVER, DEPTH GAUGE & SCREW FOR 12-078 PLANE	1	-
1-12-714	KIT 15 - FENCE, SCREW & ARM FOR 12-078 PLANE	1	-

Owning quality finishing tools says a lot about how serious a woodworker you are. Stanley's line of finishing tools is made with quality materials. The parts are precision ground, and they have features that give woodworkers greater control and accuracy.

SURFORM			
Product #	Description	Pack	Barcode
			
5-21-102	FLAT FILE PLASTIC 140MM	6	3253565211023
			
5-21-103	PLANE PLASTIC 254MM	6	325356211030
			
5-21-104	BLOCK PLANE PLASTIC 140MM	6	325356211047
			
5-21-115	SHAVER TOOL PLASTIC 60MM	2	3253565211153
			
5-21-122	PLANE FILE METAL 254MM	2	3253565211221
			
5-21-295	FLAT FILE METAL 254MM	2	325356522952

SURFORM CONTINUED			
Product #	Description	Pack	Barcode
			
5-21-399	BLOCK PLANE METAL 140MM	2	3253565213997
			
5-21-296	PLANE METAL 254MM	2	3253565212969
			
5-21-297	ROUND FILE 254MM	2	3253565212976
SURFORM BLADES			
Product #	Description	Pack	Barcode
			
5-21-291	BLADE ROUND FILE 254MM	6	3253565212914
			
5-21-293	BLADE STANDARD CUT 254MM	12	3253565212938
5-21-393	BLADE FINE CUT 254MM	12	3253565213935
5-21-508	BLADE METAL / PLASTIC 254MM	12	3253565215083
			
5-21-299	BLADE HALF ROUND 254MM	12	3253565212990
			
5-21-398	BLADE BLOCK PLANE 140MM	12	3253565213980
			
5-21-515	BLADE SHAVER TOOL 60MM	12	3253565215151

MAKE SOMETHING GREAT™

STANLEY



## FINISHING TOOLS CONTINUED

### SPOKESHAVES & CABINET SCRAPERS

Product #	Description	Pack	Barcode
-----------	-------------	------	---------



1-12-080	SCRAPER CABINET 290X70MM	1	076174120806
----------	--------------------------	---	--------------



1-12-151	SPOKESHAVE FLAT ADJUSTABLE 54MM	6	5000366121512
----------	---------------------------------	---	---------------

1-12-152	SPOKESHAVE ROUND ADJUSTABLE 54MM	6	5000366121529
----------	----------------------------------	---	---------------



1-12-337	CUTTER FOR 12-080 SCRAPER	6	-
----------	---------------------------	---	---



1-12-350	CUTTER FOR 12-151/152 SPOKESHAVE	12	-
----------	----------------------------------	----	---

## ELECTRONIC TOOLS

### LASER & INTELLI TOOLS

Product #	Description	Pack	Barcode
-----------	-------------	------	---------



77-018L	ULTRASONIC DISTANCE ESTIMATOR (NO BATTERY)	1	076174770186
---------	--	---	--------------



1-77-911	TRU LASER MEASUREMENT TLM 130i RANGE 30M	1	3253561779114
----------	--	---	---------------



1-77-917	TRU LASER MEASUREMENT TLM 160i RANGE 60M	1	3253561779176
----------	--	---	---------------



1-77-922	TRU LASER MEASUREMENT TLM 210i RANGE 100M DIGITAL POINT	1	3253561779220
----------	---	---	---------------



1-77-116	TRU LASER MEASUREMENT TLM 220i RANGE 200M DIGITAL POINT	1	3253561771163
----------	---	---	---------------

**CHISELS**

**WOOD CHISELS & SETS**

Product #	Description	Pack	Barcode
			
16-151	CHISEL BEVEL EDGE 6MM - GLOBAL	6	3253560161514
16-149	CHISEL BEVEL EDGE 10MM - GLOBAL	6	3253560161491
16-152	CHISEL BEVEL EDGE 12MM - GLOBAL	6	3253560161521
16-153	CHISEL BEVEL EDGE 16MM - GLOBAL	6	3253560161538
16-154	CHISEL BEVEL EDGE 18MM - GLOBAL	6	3253560161545
16-155	CHISEL BEVEL EDGE 22MM - GLOBAL	6	3253560161552
16-156	CHISEL BEVEL EDGE 25MM - GLOBAL	6	3253560161569
16-157	CHISEL BEVEL EDGE 32MM - GLOBAL	6	3253560161576
16-161	CHISEL BEVEL EDGE 38MM - GLOBAL	6	3253560161613



16-870	CHISEL BEVEL EDGE 6MM DYNAGRIP	6	747752168700
16-872	CHISEL BEVEL EDGE 10MM DYNAGRIP	6	747752168724
16-873	CHISEL BEVEL EDGE 12MM DYNAGRIP	6	747752168731
16-876	CHISEL BEVEL EDGE 16MM DYNAGRIP	6	747752168762
16-877	CHISEL BEVEL EDGE 19MM DYNAGRIP	6	747752168779
16-879	CHISEL BEVEL EDGE 22MM DYNAGRIP	6	747752168793
16-880	CHISEL BEVEL EDGE 25MM DYNAGRIP	6	747752168809
16-881	CHISEL BEVEL EDGE 32MM DYNAGRIP	6	747752168816
16-882	CHISEL BEVEL EDGE 38MM DYNAGRIP	6	747752168823
16-285	CHISEL SET 3P 12, 18, 25MM DYNAGRIP	6	076174162851



16-158	CHISEL SET 3P 12, 18, 25MM - GLOBAL	2	3253560161583
16-159	CHISEL SET 4P 6, 12, 18, 25MM - GLOBAL	2	3253560161590



0-16-169	CHISEL SET 4P 6, 12, 18, 25MM + OILSTONE & OIL	1	3253560161699
----------	--	---	---------------

**FATMAX COLD CHISELS & SETS**

Product #	Description	Pack	Barcode
			
4-18-327	FATMAX COLD CHISEL 76X215MM	6	3253560163277
4-18-236	FATMAX COLD CHISEL 10X140MM	6	3253560162362
4-18-294	FATMAX COLD CHISEL 45X215MM	6	3253560162942
4-18-296	FATMAX COLD CHISEL 75X215MM	6	3253560162966
4-18-293	FATMAX COLD CHISEL 75X275MM	6	3253560162935
4-18-295	FATMAX COLD CHISEL 70X215MM	6	3253560162959
4-18-297	FATMAX COLD CHISEL 100X215MM	6	3253560162973
4-18-329	FATMAX COLD CHISEL 19X300MM	6	3253560163291
4-18-299	FATMAX CHISEL & PUNCH SET 12P	6	3253560162997
4-18-328	FATMAX COLD CHISEL 100X215MM	6	3253564183284
4-18-330	FATMAX COLD CHISEL 55X250MM	6	3253564183307
4-18-331	FATMAX COLD CHISEL 72X275MM	6	3253564183314
4-18-333	FATMAX COLD CHISEL 45X250MM	6	3253564183338
4-18-332	FATMAX COLD CHISEL 25X300MM	6	3253564183332
4-18-334	FATMAX COLD CHISEL 70X215MM	6	3253564183345
4-18-298	FATMAX COLD CHISEL SET 3P	6	3253564182980

**HONING GUIDE, OIL STONE & OIL SET**

Product #	Description	Pack	Barcode
			
0-16-050	HONING GUIDE, OIL STONE & OIL - SET	4	3253560160500
0-14-050	HONING GUIDE	1	3253560140502



## MISCELLANEOUS

### ABRASIVE TOOLS

Product #	Description	Pack	Barcode
			
15-410	CARBIDE GRIT ROD SAW BLADE 250MM	10	076174154108

### WOOD CARVING SET

Product #	Description	Pack	Barcode
			
16-120	WOOD CARVING SET 6 PIECE	1	4711815161201

### AWLS

Product #	Description	Pack	Barcode
			
0-69-014	AWL BRAD 32MM X 2,5MM	12	3253560690144

### DRILL HAND

Product #	Description	Pack	Barcode
			
03-608	HAND DRILL D.PINION 8MM GLOBAL	6	4711815036080

### SCREW HOLE PUNCH

Product #	Description	Pack	Barcode
			
58-013	SCREW HOLE PUNCH	6	076174580136

### NAIL SET

Product #	Description	Pack	Barcode
			
58-230	NAILSET OF 3 - 0,8 / 1,6 / 2,4MM	6	076174582307

### FUBAR FATMAX DEMOLITION

Product #	Description	Pack	Barcode
			
55-099	FUBAR FATMAX DEMOLITION	2	076174550993

### WONDER/PRY BAR

Product #	Description	Pack	Barcode
			
55-515	WONDER/PRY BAR	4	076174555158

**MISCELLANEOUS CONTINUED**

FLASHLIGHTS			
Product #	Description	Pack	Barcode
			
95-112	FLASHLIGHT LED 369 TRIPOD (NO BATTERIES)	2	076174951127
95-113	FLASHLIGHT MINI TRIPOD KEYRING (+ BATTERY)	10	076174951134

			
			
1-95-152	FATMAX 3AAA ALUMINIUM TORCH 70 LUMENS	1	3253561951527

			
			
1-95-154	FATMAX ALUMINIUM TORCH RECHARGABLE 70 LUMENS	1	3253561951541

BENCH VICES			
Product #	Description	Pack	Barcode
			
81-600	BENCH VICE 75MM MECHANICS	1	8887329816008
81-601	BENCH VICE 100MM MECHANICS	1	8887329816015
81-602	BENCH VICE 120MM MECHANICS	1	8887329816022
81-603	BENCH VICE 150MM MECHANICS	1	8887329816039

MINI MULTICOLOUR MARKER			
Product #	Description	Pack	Barcode
			
47-329B	MINI MULTICOLOUR MARKER 72 PIECE DISPLAY CONTAINER	4	076174473292

TUBE CUTTER			
Product #	Description	Pack	Barcode
			
93-020	TUBING CUTTER 3 - 30MM	10	747752930208
93-019	TUBING CUTTER WHEEL 2 PER CARD	1	4711815930197

GLASS CUTTER			
Product #	Description	Pack	Barcode
			
14-125	GLASS CUTTER STEEL 132MM	24	747752141253

SCREEN DOOR CLOSER			
Product #	Description	Pack	Barcode
			
74-5750	SCREEN DOOR CLOSER HEAVY DUTY	5	033923011068
74-5775	SCREEN DOOR CLOSER HYDRAULIC	5	033923011082

**STANLEY** MAKE SOMETHING GREAT™



# MISCELLANEOUS CONTINUED

CORDMATE CABLE CARRIER			
Product #	Description	Pack	Barcode
			
93-150	CORDMATE CABLE CARRIER	1	6002154931500

SNIPS			
Product #	Description	Pack	Barcode
			
2-14-562	MAXSTEEL LEFT CUT 254MM	6	3253562145628
2-14-563	MAXSTEEL STRAIGHT CUT 254MM	6	3253562145635
2-14-564	MAXSTEEL RIGHT CUT 254MM	6	3253562145642

HEDGE SHEAR			
Product #	Description	Pack	Barcode
			
70-040	HEDGE SHEAR 300MM SERRATED	1	747752700405

CAMPERS AXE			
Product #	Description	Pack	Barcode
			
1-51-030	CAMPERS AXE STEELMASTER	6	3253561510304

PRUNING SAW			
Product #	Description	Pack	Barcode
			
15-675	SAW PRUNING 300MM	10	747752156752

BIT BRACES			
Product #	Description	Pack	Barcode
			
02-110	BIT BRACE 4 JAW 254MM - GLOBAL	6	747752021104
02-1105	JAW SET OF 4 FOR 02-110 BIT BRACE	1	-
1-02-715	BIT BRACE 4 JAW 254MM PROFESSIONAL	2	3253561027154

LAWN & LEAF RAKE			
Product #	Description	Pack	Barcode
			
71-062	LAWN & LEAF RAKE 22T WITH WOOD HANDLE	1	747752710626

**TOOL BAGS & BOXES**

**TOOLBAGS**

Product #	Description	Pack	Barcode
-----------	-------------	------	---------



1-93-949	16" FATMAX TOOLBAG - 400MM	4	3253561939495
----------	----------------------------	---	---------------



1-93-329	9" TOOL POUCH - 225MM	4	3253561933295
----------	-----------------------	---	---------------

**TOOLS THAT GET THE JOB DONE  
FASTER, EASIER, BETTER**



1-93-328	20" WHEELED TOOL BAG - 500MM	1	3253561933288
----------	------------------------------	---	---------------

**TOOL BAGS & BOXES**

Product #	Description	Pack	Barcode
-----------	-------------	------	---------



1-95-611	FATMAX TOOL BACKPACK	2	3253561956119
----------	----------------------	---	---------------



1-79-215	FATMAX TOOL BACKPACK ON WHEELS	1	3253561792151
----------	--------------------------------	---	---------------



1-95-629	FATMAX EXTREME TOOL VEST	4	3253561956294
----------	--------------------------	---	---------------



1-93-331	TOOL BAG OPEN MOUTH	4	3253561933318
----------	---------------------	---	---------------



# TOOL BAGS & BOXES CONTINUED

## TOOL BAGS & BOXES

Product #	Description	Pack	Barcode
-----------	-------------	------	---------



1-94-747	FATMAX LOCK & STOCK STORAGE SOLUTION	1	3253561947476
----------	--------------------------------------	---	---------------



**INCLUDES HANGERS**

1-94-746	FATMAX STOCK & CARRY BINS PK OF 3	1	3253561947469
----------	-----------------------------------	---	---------------



1-95-621	METAL/PLASTIC ROLLING WORKSHOP	1	3253561956218
----------	--------------------------------	---	---------------

## TOOL BAGS & BOXES

Product #	Description	Pack	Barcode
-----------	-------------	------	---------



1-93-293	FATMAX PRO ORGANIZER	5	3253561932939
----------	----------------------	---	---------------



1-93-935	28"/700MM FATMAX WATERPROOF TOOL BOX	1	3253561939358
----------	--------------------------------------	---	---------------

1-94-749	23"/575MM FATMAX WATERPROOF TOOL BOX	1	3253561947490
----------	--------------------------------------	---	---------------



1-93-972	HEAVY DUTY MOBILE PROJECT CENTRE	1	3253561939723
----------	----------------------------------	---	---------------



1-94-210	FATMAX 4 IN 1 CANTILEVER ROLLING W/SHOP	2	3253561942105
----------	---	---	---------------



[www.stanleyworks.co.za](http://www.stanleyworks.co.za)

**Tel: 011 472 0454 - Fax: 011 472 0482**

Whether you are a retailer looking for the best quality products to offer your customers, or a skilled end-user looking for the best tool, STANLEY is here to serve you.

STANLEY has a reputation for excellence. We continually test, design and improve our products to ensure quality and maximum function. Maintaining our standing of being the world's best at what we do is important to us and what you expect from a name like STANLEY.

This catalogue features our broad range of products. It includes such speciality hand tools as a line of ergonomically designed products, a pro line of tools made of extra durable materials tough enough for the job site, as well as an assortment of products for the DIY market.