

5 4 3 2 1

D
C
B
A

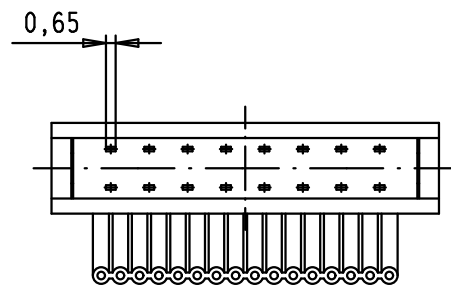

PCB layout, component side

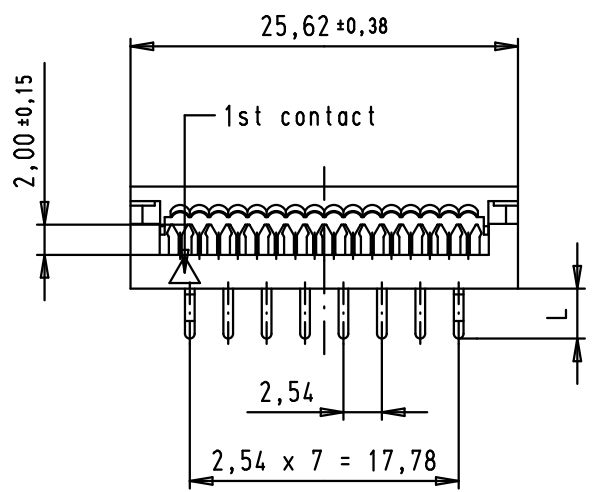
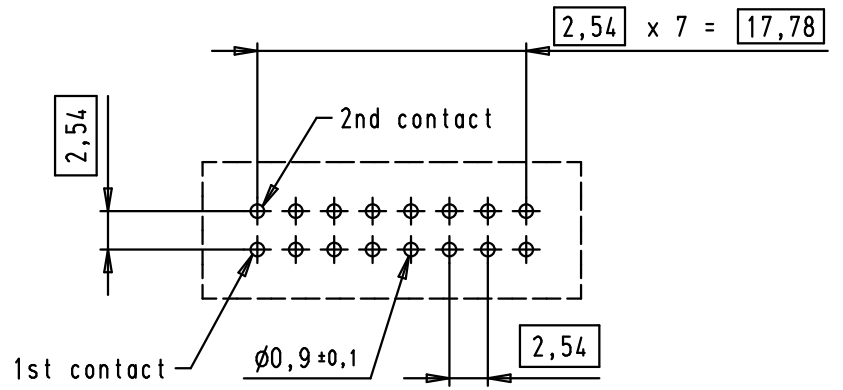

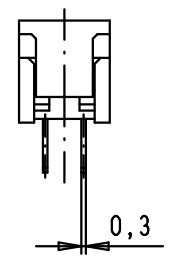

PRE-ASSEMBLED

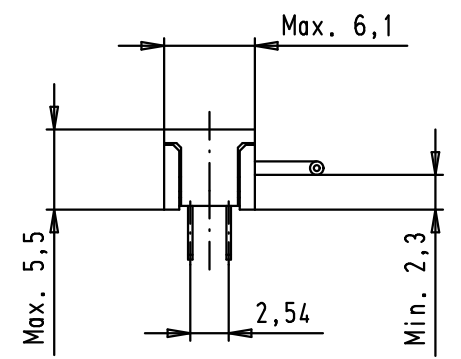

ASSEMBLED

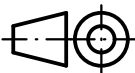

09 18 116 9622.210	3,0 ^{±0,25}	PRE-ASSEMBLED
09 18 116 9622.200	3,3 ^{±0,25}	NON ASSEMBLED
09 18 116 9622	3,3 ^{±0,25}	PRE-ASSEMBLED
Part number	L	COVER

				Dat.	Name	 All Dim. in mm Orig. Size DIN A 4
			Detail.	02/04/04	JH	
			Insp.			
			Stand.			
34919	30/05/08	PK	HARTING EURL F-95972 Paris			
34889	08/04/08	PK	Mod.	Dat.	Name	
31884	02/04/04	JH				

SEK 18, low profile, PCB transition, 16 poles, 2 rows	Maßstab/ Scale 2:1
TB 09 18 116 9622	Blatt/ Page 1 / 1
Sub.	