

Spezifikation für Freigabe / specification for release

Kunde / customer : _____
 Artikelnummer / part number : **748421245**
 Bezeichnung : **SMD-Balun WE-BAL**
 description : **Chip-Balun WE-BAL**

LF



DATUM / DATE : 2004-10-11

A Mechanische Abmessungen / dimensions:

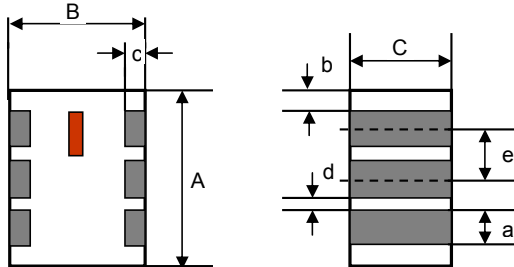

size	0805	
A	2,0 ± 0,1	mm
B	1,25 ± 0,1	mm
C	0,85 ± 0,1	mm
a	0,3 ± 0,1	mm
b	0,2 ± 0,1	mm
c	0,3 +0,1/-0,2	mm
d	0,35 ± 0,1	mm
e	0,65 ± 0,05	mm

B Elektrische Eigenschaften / electrical properties:

Eigenschaften / properties	Testbedingungen / test conditions		Wert / value	Einheit / unit	tol.
Frequenzbereich/ frequency range		f	2400 ... 2500	MHz	
Einfügedämpfung/ insertion loss	2400 ... 2500 MHz		1,0	dB	max.
Einfügedämpfung/ insertion loss	2400 ... 2500 MHz		0,54	dB	typ.
VSWR/ VSWR	2400 ... 2500 MHz		2,0		max.
VSWR/ VSWR	2400 ... 2500 MHz		1,32		typ.
Phasendifferenz/ phase imbalance			180	°	± 10°
Amplitudendifferenz/ amplitude imbalance			2,0	dB	max.
Eingangsimpedanz/ unbalanced impedance		Z	50	Ω	typ.
Ausgangsimpedanz/ balanced impedance		Z	100	Ω	typ.

C Abbildung/ appearance:



D Prüfgeräte / test equipment:

Network Analyzer Agilent E5071B

E Testbedingungen / test conditions:

Luftfeuchtigkeit / humidity: 50 ~ 70%
 Umgebungstemperatur / temperature: 20°C ~ 25°C

F Werkstoffe & Zulassungen / material & approvals

Basismaterial / base material: Keramik / ceramic
 Kontaktmaterial / contact plating: AG + Ni + Sn

G Eigenschaften / general specifications:

Betriebstemp. / operating temperature: -40°C - +85°C
 Lagerbedingungen / storage conditions: 15°C ~ 35°C
 45 ~ 75% RH
 Leistung/ power capacity : 3 W max.

Freigabe erteilt / general release:	Kunde / customer			
			
Datum / date	Unterschrift / signature			
	Würth Elektronik			
			
Geprüft / checked	Kontrolliert / approved		AWe	Version 1
			Name	Änderung / modification
				Datum/date

Würth Elektronik eiSos GmbH & Co.KG

D-74638 Waldenburg · Max-Eyth-Str. 1 · Germany · Telefon (+49) (0) 7942 - 945 - 0 · Telefax (+49) (0) 7942 - 945 - 400
<http://www.we-online.de>

Spezifikation für Freigabe / specification for release

Kunde / customer : _____
 Artikelnummer / part number : **748421245**
 Bezeichnung : **SMD-Balun WE-BAL**
 description : **Chip-Balun WE-BAL**

LF



H Lötadempfehlung / solder pads:

ohne/ without DC-feed:

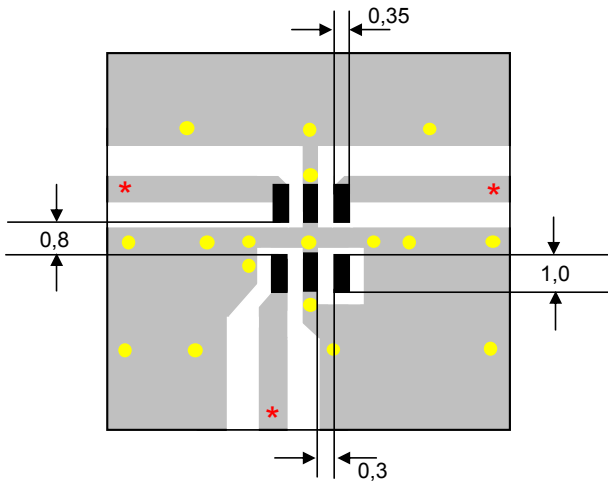

mit/ with DC-feed:

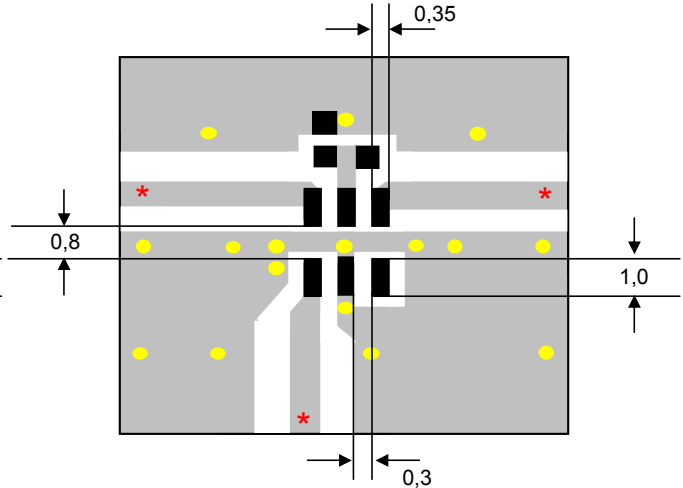

* Line width should be designed to provide proper impedance matching characteristics, depending on PCB material and thickness.

** Bypass capacitor should be connected when feeding DC power

- Solder Resist
- Land
- Through-hole (Ø 0.3)

Units: mm

K Messdiagramme/ measuring diagrams:

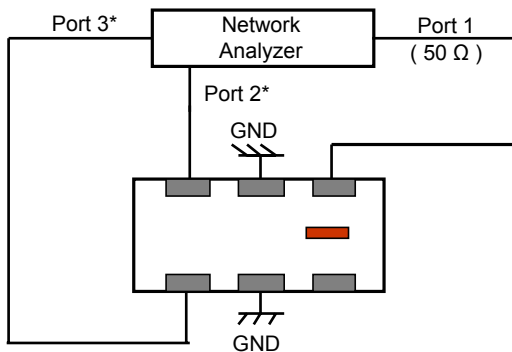

* Impedance for ports 2 and 3 = 1/2 (Balanced Impedance)

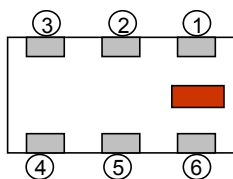

No.	Terminal Name	No.	Terminal Name
①	Unbalanced Port (IN)	④	Balanced Port (OUT 2)
②	GND or DC feed + RF GND	⑤	GND
③	Balanced Port (OUT 1)	⑥	NC

Würth Elektronik eiSos GmbH & Co.KG

D-74638 Waldenburg · Max-Eyth-Str. 1 · Germany · Telefon (+49) (0) 7942 - 945 - 0 · Telefax (+49) (0) 7942 - 945 - 400
<http://www.we-online.de>

Spezifikation für Freigabe / specification for release

Kunde / customer :

Artikelnummer / part number : **748421245**

Bezeichnung : **SMD-Balun WE-BAL**

description : **Chip-Balun WE-BAL**

LF



DATUM / DATE : 2004-10-11

L Messdiagramme / measuring diagrams:

Insertion Loss (dB)

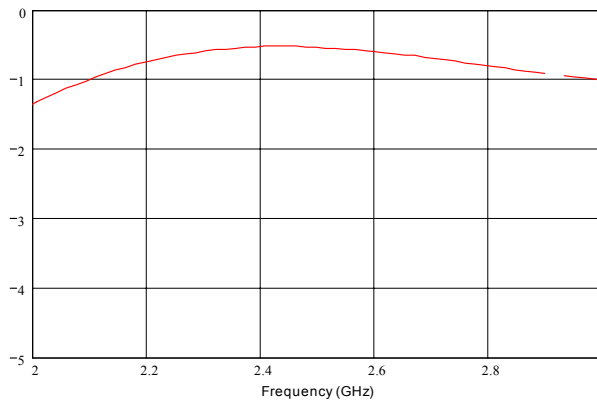

Return Loss (dB)

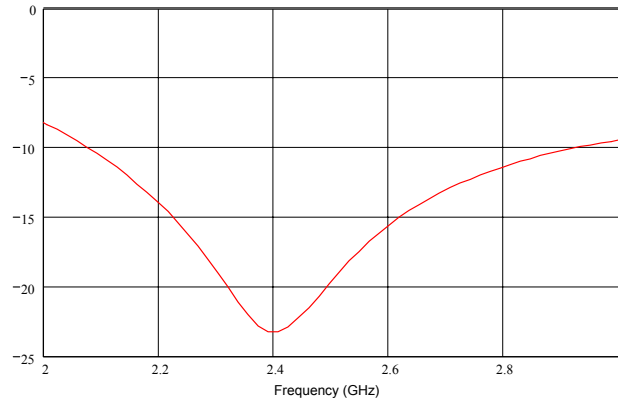

Amplitude Balance (dB)

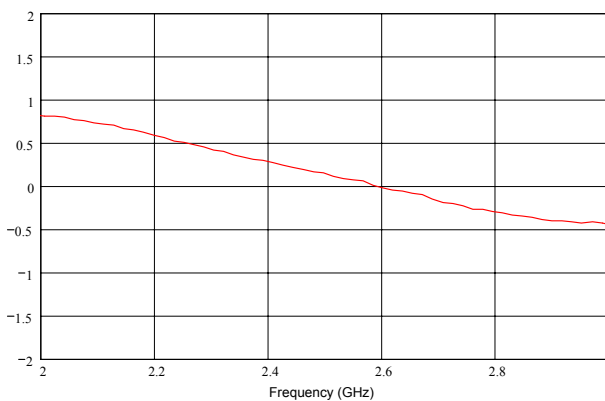

Phase Balance (degree)

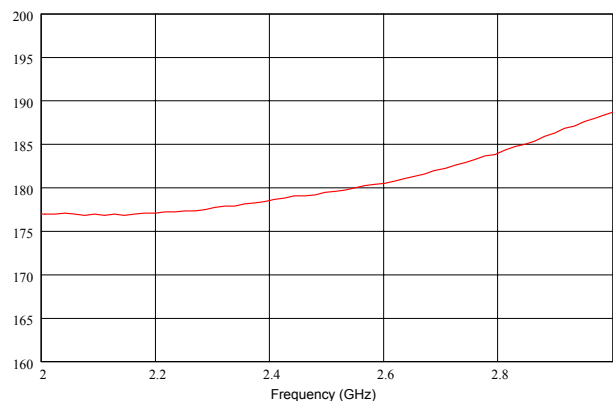

This electronic component is designed and developed with the intention for use in general electronics equipments. Before incorporating the components into any equipments in the field such as aerospace, aviation, nuclear control, submarine, transportation, (automotive control, train control, ship control), transportation signal, disaster prevention, medical, public information network etc. where higher safety and reliability are especially required or if there is possibility of direct damage or injury to human body. In addition, even electronic component in general electronic equipments, when used in electrical circuits that require high safety, reliability functions or performance, the sufficient reliability evaluation-check for the safety must be performed before use. It is essential to give consideration when to install a protective circuit at the design stage.

Würth Elektronik eiSos GmbH & Co.KG

D-74638 Waldenburg · Max-Eyth-Str. 1 · Germany · Telefon (+49) (0) 7942 - 945 - 0 · Telefax (+49) (0) 7942 - 945 - 400
<http://www.we-online.de>

Spezifikation für Freigabe / specification for release

Kunde / customer : _____
 Artikelnummer / part number : **748421245**

LF



Bezeichnung : **SMD-Balun WE-BAL**
 description : **Chip-Balun WE-BAL**

DATUM / DATE : 2004-10-11

I Rollenspezifikation / tape and reel specification :

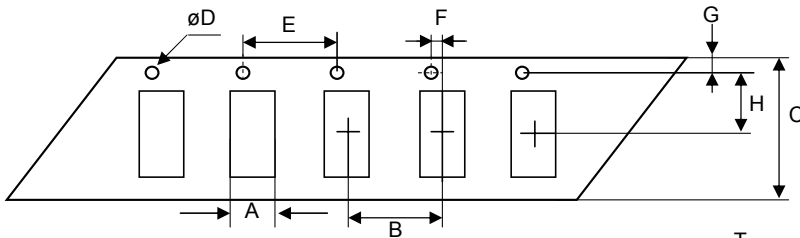

Gurtspezifikation / Tape specification:

A	1,6 ± 0,1	mm
B	4,0 ± 0,1	mm
C	8,0 ± 0,2	mm
D	1,5 +0,1/-0,0	mm
E	4,0 ± 0,1	mm
F	2,0 ± 0,1	mm
G	1,75 ± 0,1	mm
H	3,5 ± 0,1	mm
I	2,4 ± 0,1	mm
J	1,3 max.	mm
T	0,2 ± 0,05	mm

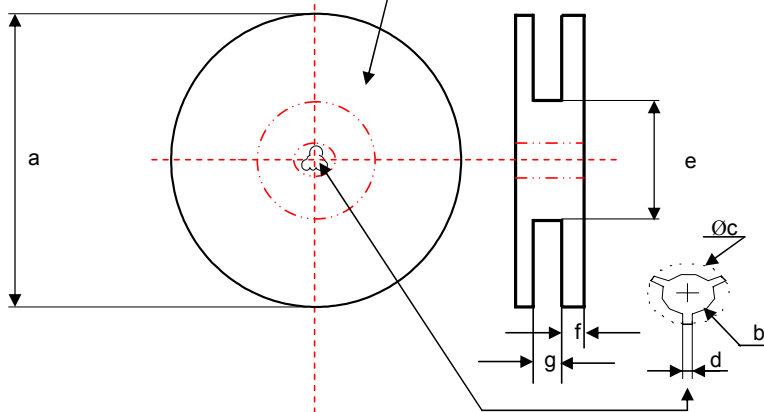

Rollenspezifikation / Reel specification:

a	178,0 ± 2,0	mm
b	13,0 ± 0,3	mm
c	21,8 ± 0,8	mm
d	2,0 ± 0,5	mm
e	60,0 ± 0,5	mm
f	1,2 ± 2,0	mm
g	9,0 ± 0,3	mm

The force for tearing off cover tape is 10 to 130 grams in arrow direction

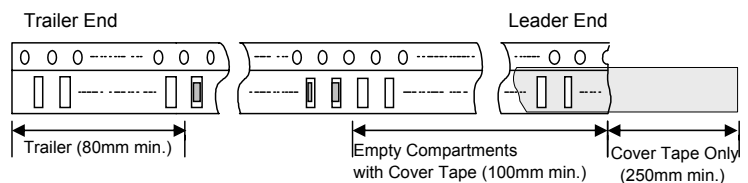
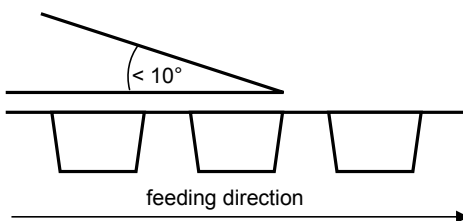

Freigabe erteilt / general release:	Kunde / customer	
Datum / date	Unterschrift / signature	
	Würth Elektronik	
Geprüft / checked	Kontrolliert / approved	AWe Version 1 04-10-11
		Name Änderung / modification Datum/date

Würth Elektronik eiSos GmbH & Co.KG

D-74638 Waldenburg · Max-Eyth-Str. 1 · Germany · Telefon (+49) (0) 7942 - 945 - 0 · Telefax (+49) (0) 7942 - 945 - 400
<http://www.we-online.de>