

Datasheet

Union F/F, 3/4"

RS Stock number 499-3502

A VIEW

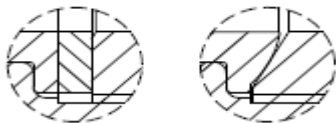

Flat union Conical union



Conical union
with conical seat

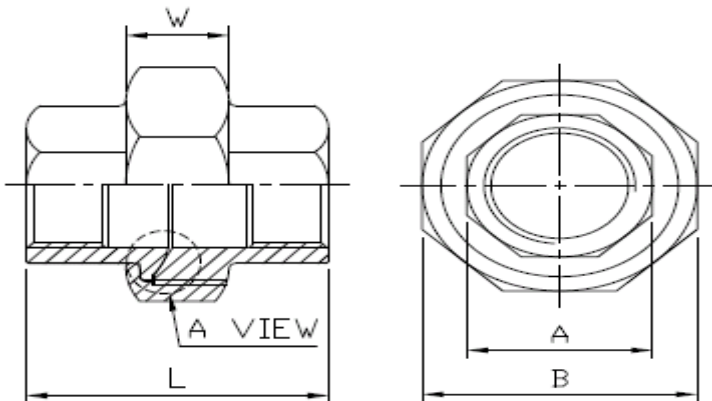

1/8"~1/4" Hexagon
3/8"~1" Octagon
1-1/4"~4" Decagon

Standard Pattern

SIZE	1/8"		1/4"		3/8"		1/2"		3/4"		1"		1-1/4"		1-1/2"		2"		2-1/2"		3"		4"	
	mm	in	mm	in	mm	in	mm	in	mm	in	mm	in	mm	in	mm	in	mm	in	mm	in	mm	in	mm	in
L	34.5	1.36	34.5	1.36	37.6	1.48	38.6	1.52	44	1.73	51	2.01	58	2.28	59	2.32	61.5	2.42	71	2.8	90	3.54	97	3.82
A	17.2	0.68	17.5	0.69	20.5	0.81	26.5	1.04	31.2	1.23	38	1.5	47.5	1.87	54	2.13	67	2.64	83	3.27	96	3.78	122.5	4.82
B	28	1.1	28	1.1	34	1.34	39.2	1.54	46	1.81	55	2.17	63.2	2.49	71	2.8	85	3.35	105.5	4.15	123.7	4.87	153.5	6.04
W	12.2	0.48	12.2	0.48	15	0.59	15	0.59	15	0.59	17	0.67	20	0.79	20	0.79	20.8	0.82	24	0.94	28	1.1	33	1.3

Tolerance: ±0.5mm(1/8"~2")
±0.8mm(2-1/2"~4")

Economic Pattern

SIZE	1/8"		1/4"		3/8"		1/2"		3/4"		1"		1-1/4"		1-1/2"		2"		2-1/2"		3"		4"	
	mm	in	mm	in	mm	in	mm	in	mm	in	mm	in	mm	in	mm	in	mm	in	mm	in	mm	in	mm	in
L	34.5	1.36	34.5	1.36	37.6	1.48	38.6	1.52	44	1.73	51	2.01	58	2.28	59	2.32	61.5	2.42	71	2.8	90	3.54	97	3.82
A	16.5	0.65	16.5	0.65	20	0.79	25	0.98	30	1.18	36	1.42	45	1.77	52	2.05	64	2.52	80	3.15	93	3.66	118	4.65
B	27	1.06	27	1.06	30	1.18	36	1.42	41	1.61	50	1.97	57.5	2.26	65	2.56	77	3.03	96	3.78	112	4.41	138	5.43
W	12.2	0.48	12.2	0.48	15	0.59	15	0.59	15	0.59	17	0.67	20	0.79	20	0.79	20.8	0.82	24	0.94	28	1.1	33	1.3

Tolerance: ±0.5mm(1/8"~2")
±0.8mm(2-1/2"~4")