



KERN & Sohn GmbH

Ziegelei 1
D-72336 Balingen
E-Mail: info@kern-sohn.com

Tel: +49-[0]7433- 9933-0
Fax: +49-[0]7433-9933-149
Internet: www.kern-sohn.com

Operating instruction Counting scales

KERN CXB/CXP

Version 1.7
10/2014
GB



CXB/CXP-BA-e-1417



KERN CXB/CXP

Version 1.7 10/2014

Operating instruction Counting scales

Table of Contents

1	Technical data	4
2	Declaration of conformity	7
3	Appliance overview	8
3.1	Overview of display	10
3.1.1	Display weight.....	11
3.1.2	Display reference weight	11
3.1.3	Display quantity.....	11
3.1.4	Battery charge status display.....	11
3.2	Keyboard overview	12
4	Basic Information (General)	14
4.1	Proper use.....	14
4.2	Improper Use.....	14
4.3	Warranty	14
4.4	Monitoring of Test Resources.....	15
5	Basic Safety Precautions	15
5.1	Pay attention to the instructions in the Operation Manual	15
5.2	Personnel training	15
6	Transport and storage	15
6.1	Testing upon acceptance	15
6.2	Packaging.....	15
7	Unpacking, Setup and Commissioning	16
7.1	Installation Site, Location of Use.....	16
7.2	Unpacking	16
7.2.1	Setup	17
7.2.2	Scope of delivery	18
7.3	Mains connection	18
7.4	Battery power supply	18
7.5	Initial Commissioning	18
7.5.1	Start-up.....	19
7.5.2	Turn off – CXB models	19
7.5.3	Turn off/standby mode – CXP models	19
7.5.4	Balance zero display.....	19
7.5.5	Stability display	19
7.6	Adjustment with external weight	20
7.6.1	Adjustment of models CXP	20
7.6.2	Adjustment of models CXB	21
7.6.3	Adjustment of models CXB_M	23
8	Verification	24
8.1	Adjustment key and seals.....	25
9	Parts counting	26
9.1	Determination of the reference weight by weighing	26
9.2	Numeric entering of the reference weight	27

9.3	Automatic reference optimization	27
9.4	Store/call reference weight	28
9.4.1	Save.....	28
9.4.2	Call-up	29
9.5	Count with tolerance control - Fill to target	29
9.5.1	Set tolerance value for target number of pieces.....	29
9.5.2	Set tolerance value for target weight	30
10	Taring	31
10.1	Determination of the tare weight by weighing.....	31
10.2	Numerical input of tare (PRE-TARE).....	32
10.3	Numerical input of tare (PRE-TARE).....	35
11	Add up	37
11.1	Add up "number parts"	37
11.2	Add up "weight"	38
11.3	Delete stored values.....	39
12	Application menu	39
12.1	Navigation in the menu	39
12.2	Menu overview [USER].....	40
13	Configurations menu	41
13.1.1	Display background illumination.....	41
13.1.2	Setting the display speed	42
14	Data output	43
14.1	RS 232C interface	43
14.2	Description of interface	44
14.2.1	Example: Setting an output format.....	48
15	Service, maintenance, disposal	49
15.1	Cleaning.....	49
15.2	Service, maintenance	49
15.3	Disposal.....	49
16	Instant help	50
17	Appendix ASCII CODE table	51

1 Technical data

CXB models:

KERN	CXB 3K0.2	CXB 6K0.5	CXB 15K1	CXB 30 K2
Readability (d)	0.2 g	0.5 g	1 g	2 g
Weighing range (max)	3 kg	6 kg	15 kg	30 kg
Reproducibility	0.2 g	0.5 g	1 g	2 g
Linearity	± 0.4 g	± 1.0 g	± 2 g	± 4 g
Stabilization time	2 sec.	2 sec.	2 sec.	2 sec.
Recommended adjustment weight, not added (class)	3 kg (M1)	5 kg (M1)	15 kg (M1)	30 kg (M1)
Weighing unit	g	g	g	g
Minimum piece weight	0.1 g	0.2 g	0.5 g	1 g
Warming up time (operating temperature)	30 min			
Reference quantity	freely selectable			
Net weight (kg)	4 kg			
Permissible ambient condition	-10° C to 40° C			
Humidity of air	15% - 85% (non-condensing)			
Weighing plate, stainless steel	300 x 225 mm			
Dimensions of the housing (B x D x H)	300 x 330 x 110 mm			
Mains connection	Mains adapter 230 V, 50/60 Hz ; 9 V DC balance, 800 mA			
Rechargeable battery	Without backlight display: Service life c. 200 hours / loading time ca. 8 hrs.			
	With backlight display: Operating time ca. 60h. / loading time ca. 8 hrs.			

KERN	CXB 3K1NM	CXB 6K2NM	CXB 15K5NM	CXB 30K10NM
Readability (d)	1 g	2 g	5 g	10 g
Weighing range (Max)	3 kg	6 kg	15 kg	30 kg
Minimum load (Min)	20 g	40 g	100 g	200 g
Verification value (e)	1 g	2 g	5 g	10 g
Reproducibility	1 g	2 g	5 g	10 g
Linearity	2 g	4 g	10 g	20 g
Verification class	III	III	III	III
Stabilization time	2 sec.	2 sec.	2 sec.	2 sec.
Recommended adjustment weight, not added (class)	3 kg (M1)	6 kg (M1)	15 kg (M1)	30 kg (M1)
Weighing unit	kg	kg	kg	kg
Minimum piece weight	100 mg	200 mg	500 mg	1 g
Warming up time (operating temperature)	10 min			
Reference quantity	freely selectable			
Net weight (kg)	4 kg			
Permissible ambient condition	-10° C bis 40° C			
Allowable air humidity	15% - 85% (non-condensing)			
Weighing plate, stainless steel	300 x 225 mm			
Dimensions of the housing plastic material (B x D x H)	300 x 330 x 110			
Voltage	220-240 V, 50/60 Hz;			
Rechargeable battery	Without backlight display: Service life ca. 200Std. / loading time ca. 8 Std.			
	with back light: Operating time ca. 60Std. / loading time ca. 8 Std.			

CXP models:

KERN	CXP 30K2	CXP 75K5	CXP 150K10
Readability (d)	2 g	5 g	10 g
Weighing range (max)	30 kg	75 kg	150 kg
Reproducibility	2 g	5 g	10 g
Linearity	± 4 g	± 10 g	± 20 g
Stabilization time	2 sec.	2 sec.	2 sec.
Recommended adjustment weight, not added (class)	20 kg (M1)	50 kg (M1)	100 kg (M1)
Weighing unit	g	g	g
Minimum piece weight	0.5 g	1 g	2.5 g
Warming up time (operating temperature)	30 min		
Reference quantity	freely selectable		
Net weight (kg)	8.9 kg		
Permissible ambient condition	-10° C to 40° C		
Allowable air humidity	15 % - 85 % (non-condensing)		
Weighing plate, stainless steel	400 x 300 mm		
Dimensions of the housing plastic material (B x D x H)	400 x 300 x 100 mm (platform)		
	290 x 140 mm (terminal)		
Voltage	230 V (AC)		
Rechargeable battery	Without backlight display: Service life c. 200 hours / loading time ca. 16 hrs.		
	With backlight display: Operating time ca. 60h. / loading time ca. 16 hrs.		
	with backlight + RS 232: Operating time ca. 56h. / loading time ca. 16 hrs.		
Data interface	RS 232C		

2 Declaration of conformity



KERN & Sohn GmbH

D-72322 Balingen-Frommern

Postfach 4052

E-Mail: info@kern-sohn.de

Tel: 0049-[0]7433- 9933-0

Fax: 0049-[0]7433-9933-149

Internet: www.kern-sohn.de

Declaration of conformity

EC-Konformitätserklärung
EC- Déclaration de conformité
EC-Dichiarazione di conformità
EC- Declaração de conformidade
EC-Deklaracja zgodności

EC-Declaration of -Conformity
EC-Declaración de Conformidad
EC-Conformiteitverklaring
EC- Prohlášení o shode
EC-Заявление о соответствии

D	Konformitäts- erklärung	Wir erklären hiermit, dass das Produkt, auf das sich diese Erklärung bezieht, mit den nachstehenden Normen übereinstimmt.
GB	Declaration of conformity	We hereby declare that the product to which this declaration refers conforms with the following standards.
CZ	Prohlášení o shode	Tímto prohlašujeme, že výrobek, kterého se toto prohlášení týká, je v souladu s níže uvedenými normami.
E	Declaración de conformidad	Manifetamos en la presente que el producto al que se refiere esta declaración está de acuerdo con las normas siguientes
F	Déclaration de conformité	Nous déclarons avec cela responsabilité que le produit, auquel se rapporte la présente déclaration, est conforme aux normes citées ci-après.
I	Dichiarazione di conformità	Dichiariamo con ciò che il prodotto al quale la presente dichiarazione si riferisce è conforme alle norme di seguito citate.
NL	Conformiteit- verklaring	Wij verklaren hiermede dat het product, waarop deze verklaring betrekking heeft, met de hierna vermelde normen overeenstemt.
P	Declaração de conformidade	Declaramos por meio da presente que o produto no qual se refere esta declaração, corresponde às normas seguintes.
PL	Deklaracja zgodności	Niniejszym oświadczamy, że produkt, którego niniejsze oświadczenie dotyczy, jest zgodny z poniższymi normami.
RUS	Заявление о соответствии	Мы заявляем, что продукт, к которому относится данная декларация, соответствует перечисленным ниже нормам.

Electronic Balance: KERN CXB/RXB/CXP

EU Directive	Standards
2004/108/EC	EN55011: 2007 +A2: 2007 EN61000-6-2:2005 EN61000-3-2:2006 EN 61000-3-3:1995+A1: 2001+A2:2005
2006/95/EC	EN 61010-1:2001

Datum 08.04.2013
Date

Ort der Ausstellung 72336 Balingen
Place of issue

Signatur
Signature

Albert Sauter
KERN & Sohn GmbH
Geschäftsführer
Managing director

KERN & Sohn GmbH, Ziegelei 1, D-72336 Balingen, Tel. +49-[0]7433/9933-0
Fax +49-[0]7433/9933-149, E-Mail: info@kern-sohn.com, Internet: www.kern-sohn.com

3 Appliance overview

CXB models:

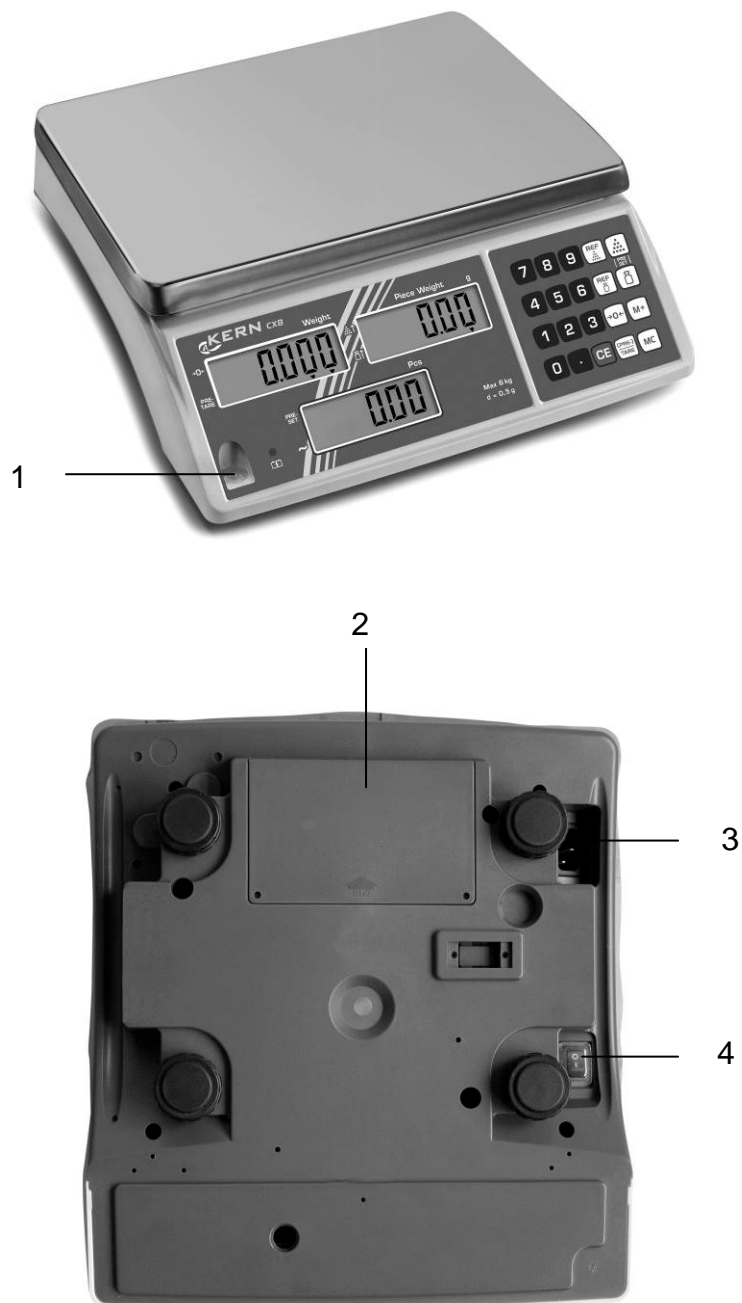

1. Bubble level
2. Battery compartment
3. Mains cable connection
4. ON/OFF switch

CXP models:



1. ON/OFF switch
2. Mains cable connection
3. RS 232 interface
4. Bubble level

3.1 Overview of display

CXB models:

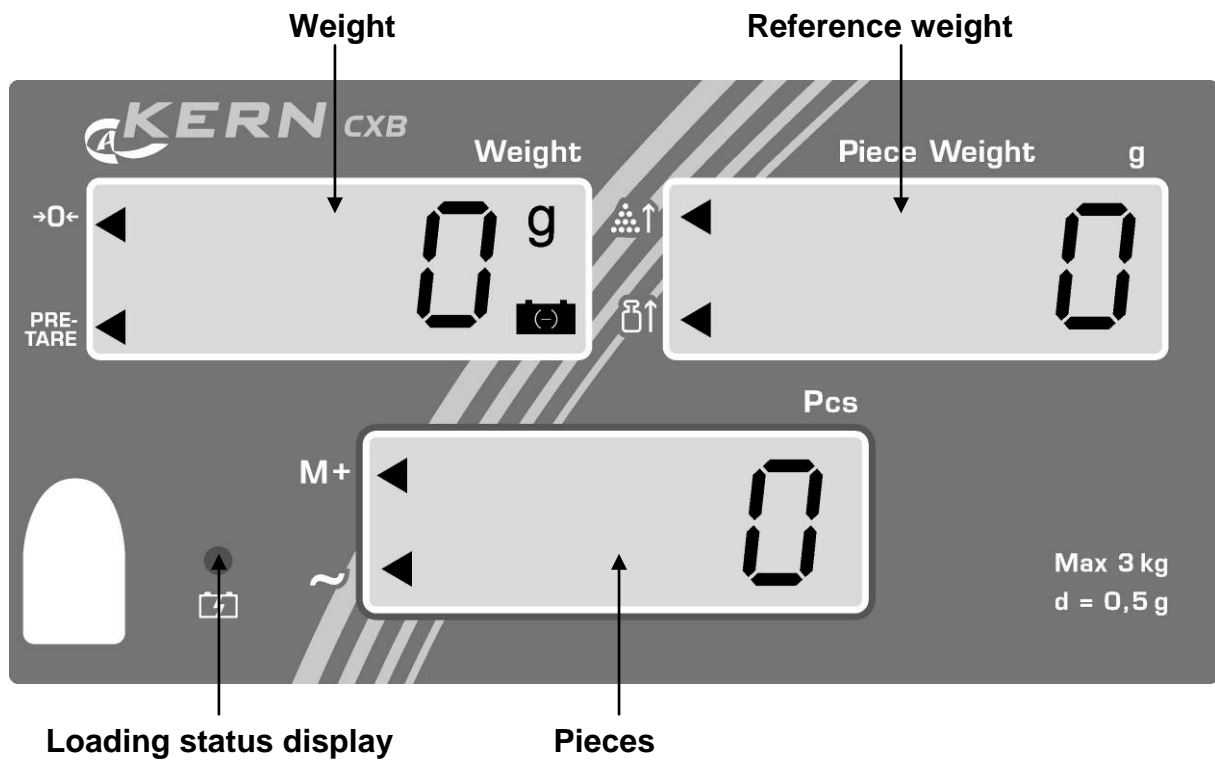

CXP models:

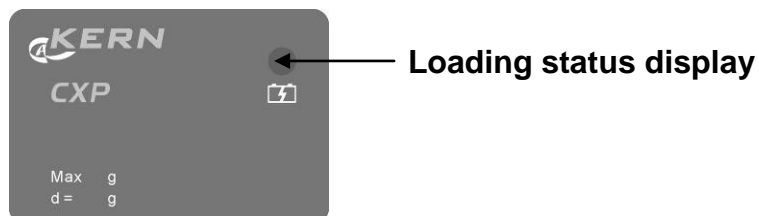
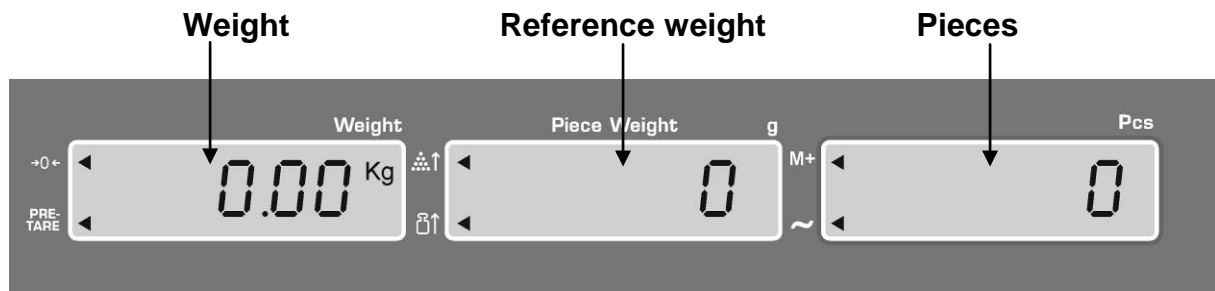

3.1.1 Display weight

Here, the weight of your goods is displayed.

Overlay ◀ indicates:

	Zeroing display
PRE-TARE	Tare in memory
	Battery very low

3.1.2 Display reference weight

The reference weight of a sample is shown here. This value is either entered by user or calculated by balance.

Overlay ◀ indicates:

	Placed number of pieces insufficient for reference calculation
	Placed reference weight insufficient for reference calculation

3.1.3 Display quantity

Here, all the parts placed on balance are immediately displayed by number.

Overlay ◀ indicates:

M+	Data in summation memory
	Stability display

3.1.4 Battery charge status display

red	Battery is almost discharged
green	Battery is completely discharged











3.2 Keyboard overview

CXB models:

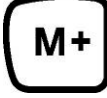

CXP models:

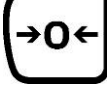

Choice	Function
	<ul style="list-style-type: none"> Number keys
	<ul style="list-style-type: none"> Delete key
	<ul style="list-style-type: none"> Call counting with tolerance control
	<ul style="list-style-type: none"> Store reference weights in memory Call stored reference weights
	<ul style="list-style-type: none"> Addition in total memory Call up total memory
	<ul style="list-style-type: none"> Delete summation memory
	<ul style="list-style-type: none"> Enter reference weight through weighing Display reference weight stored last Enter target number of pieces
	<ul style="list-style-type: none"> Numeric entry reference weight Display reference weight stored last Enter target weight
	<ul style="list-style-type: none"> Zeroing key Back to weighing mode
 CXB models	<ul style="list-style-type: none"> Taring key Enter numerical tare
 CXP models	<ul style="list-style-type: none"> ON/OFF standby Taring key Enter numerical tare

4 Basic Information (General)

4.1 Proper use

The balance you purchased is intended to determine the weighing value of material to be weighed. It is intended to be used as a “non-automatic“ balance, i.e. the material to be weighed is manually and carefully placed in the centre of the weighing plate. As soon as a stable weighing value is reached the weighing value can be read.

4.2 Improper Use

Do not use balance for dynamic weighings. In the event that small quantities are removed or added to the material to be weighed, incorrect weighing results can be displayed due to the “stability compensation“ in the balance. (Example: Slowly draining fluids from a container on the balance.)

Do not leave permanent load on the weighing plate. This may damage the measuring system.

Impacts and overloading exceeding the stated maximum load (max) of the balance, minus a possibly existing tare load, must be strictly avoided. Balance may be damaged by this.

Never operate balance in explosive environment. The serial version is not explosion protected.

The structure of the balance may not be modified. This may lead to incorrect weighing results, safety-related faults and destruction of the balance.

The balance may only be used according to the described conditions. Other areas of use must be released by KERN in writing.

4.3 Warranty

Warranty claims shall be voided in case

- Our conditions in the operation manual are ignored
- The appliance is used outside the described uses
- The appliance is modified or opened
- Mechanical damage or damage by media, liquids, natural wear and tear
- The appliance is improperly set up or incorrectly electrically connected
- The measuring system is overloaded

4.4 Monitoring of Test Resources

In the framework of quality assurance the measuring-related properties of the balance and, if applicable, the testing weight, must be checked regularly. The responsible user must define a suitable interval as well as type and scope of this test. Information is available on KERN's home page (www.kern-sohn.com) with regard to the monitoring of balance test substances and the test weights required for this. In KERN's accredited DKD calibration laboratory test weights and balances may be calibrated (return to the national standard) fast and at moderate cost.

5 Basic Safety Precautions

5.1 Pay attention to the instructions in the Operation Manual

Carefully read this operation manual before setup and commissioning, even if you are already familiar with KERN balances.

5.2 Personnel training

The appliance may only be operated and maintained by trained personnel.

6 Transport and storage

6.1 Testing upon acceptance

When receiving the appliance, please check packaging immediately, and the appliance itself when unpacking for possible visible damage.

6.2 Packaging

Keep all parts of the original packaging in case you need to return the appliance.

Only use original packaging for returning.

Before sending, disconnect all connected cables and loose/movable parts.

Attach possibly existing transport safeguards. Secure all parts, e.g. weighing plate, power unit etc., to prevent slipping and damage.

7 Unpacking, Setup and Commissioning

7.1 Installation Site, Location of Use

The balances are designed in a way that reliable weighing results are achieved in common conditions of use.

You will work accurately and fast, if you select the right location for your balance.

Therefore, observe the following for the installation site:

- Place the balance on a firm, level surface;
- Avoid extreme heat as well as temperature fluctuation caused by installing next to a radiator or in the direct sunlight;
- Protect the balance against direct draughts due to open windows and doors;
- Avoid jarring during weighing;
- Protect the balance against high humidity, vapours and dust;
- Do not expose the device to extreme dampness for longer periods of time. Non-permitted condensation (condensation of air humidity on the appliance) may occur if a cold appliance is taken to a considerably warmer environment. In this case, acclimatize the disconnected appliance for ca. 2 hours at room temperature.
- Avoid static charge of goods to be weighed or weighing container.

Major display deviations (incorrect weighing results) may be experienced should electromagnetic fields (e.g. due to mobile phones or radio equipment), static electricity accumulations or instable power supply occur. Change location or remove source of interference.

7.2 Unpacking

Carefully remove the balance from the packaging, remove plastic cover and setup balance at the intended workstation.

7.2.1 Setup

Level balance with foot screws until the air bubble of the water balance is in the prescribed circle.

Models CXP:

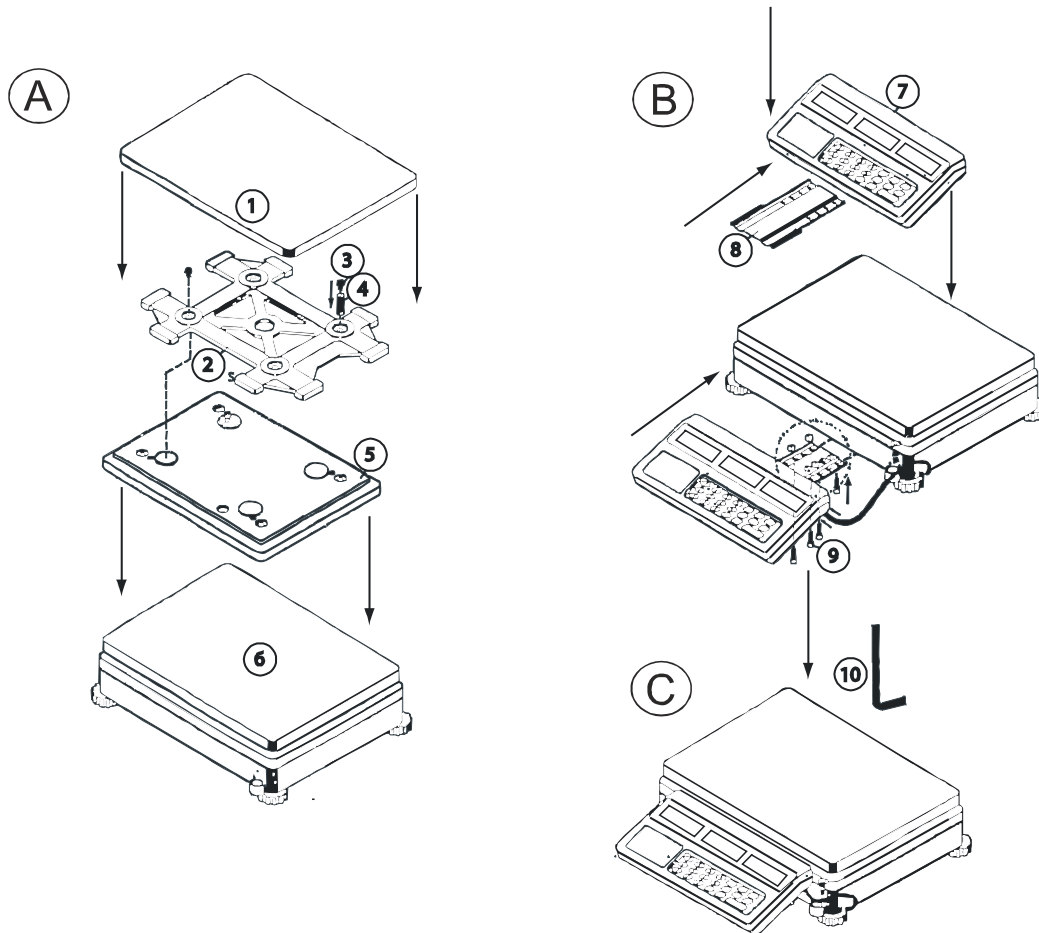

1	Weighing plate	6	Platform
2	Cantilever	7	Display part
3	Screws (x 2)	8	Support
4	Spring	9	Screws (x 4)
5	Substructure	10	Allen keys

A) Insert screw (3) in eye of spring (4) and screw it down.
Screw down second screw (3) as well.

B) Push the holder (8) into the guide rail of the display part (7).

Attach the display part (7) to the weighing balance, using the four screws (9). Use an Allen key (10) to tighten the screws.

7.2.2 Scope of delivery

Serial accessories:

CXB models	CXP models
<ul style="list-style-type: none">▪ Balance▪ Weighing plate▪ Mains power supply▪ Protective cover▪ Internal battery▪ Operating Manual	<ul style="list-style-type: none">▪ Platform▪ Terminal▪ Mains power supply▪ Protective cover▪ Internal battery▪ Operating Manual

7.3 Mains connection

Power is supplied via the external mains adapter. The stated voltage value must be the same as the local voltage.

Only use original KERN mains adapters. Using other makes requires consent by KERN.

7.4 Battery power supply

The optionally supplied battery is charged with the supplied power supply.

Before the first use, the battery should be charged by connecting it to the mains power supply for at least 15 hours. The battery has a service life of c. 200 hours without background lighting or 60 hours with background lighting. The charging period for total charge is c. 8 hours

The appearance of the battery symbol  in the weight display indicates that the battery is almost exhausted. If no weighing process is carried out during the red LED display, the balance will switch off automatically after about 20-30 minutes. Connect the power adaptor as soon as possible to change the battery.

The LED display provides information about the battery's charging status.

red: Battery is almost discharged

green: Battery is completely discharged

7.5 Initial Commissioning

In order to obtain exact results with the electronic balances, your balance must have reached the operating temperature (see warming up time chap. 1). During this warming up time the balance must be connected to the power supply (mains, accumulator or battery).

The accuracy of the balance depends on the local acceleration of gravity. Strictly observe hints in chapter Adjustment.

7.5.1 Start-up

Turn on scales with **ON/OFF** switch (left).

The balance will carry out a self-test As soon as the weight display shows "0" in all the three display windows your balance is ready to weigh.

On CXP models (with RS 232) an internal number appears before the balance counts down to zero.

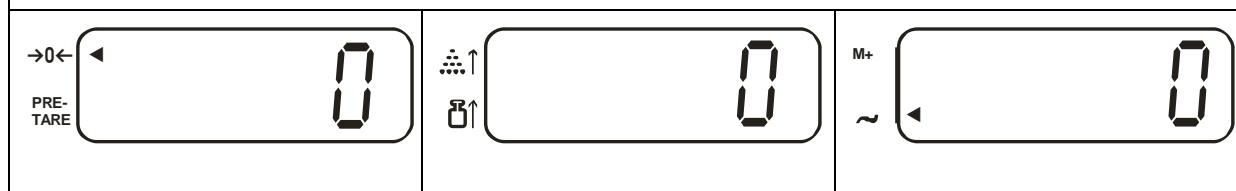

7.5.2 Turn off – CXB models

- Turn off balance by operating the **ON/OFF** switch (left)

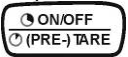

7.5.3 Turn off/standby mode – CXP models

- To turn off the balance for a **long period of time** use the **ON/OFF** switch (left).
- To turn off the balance for a **short period of time** use the  key.

To do this, press the  key until "OFF" is displayed. Balance is in standby mode (this avoids the required warm-up time). Restart the balance by pressing the  key.

7.5.4 Balance zero display

Environmental influences can lead to the exact figure of zero not being displayed in spite of an empty weighing dish. It is, however, possible to reset your balance to zero at any time and thus ensure that weighing really does commence at zero. Setting to zero when a weight is applied is only possible within a certain type-dependent range. In the event that the balance cannot be reset to zero with an applied weight, this range has been exceeded ($\pm 0,2$ % max).

To reset the balance to zero, press key . A triangle [] pops up next to the [] symbol on the display.

7.5.5 Stability display

If a triangle [] pops up next to the [] symbol on the display, the balance is in a stable state. If the status is instable the [] display disappears.

7.6 Adjustment with external weight

As the acceleration value due to gravity is not the same at every location on earth, each balance must be coordinated - in compliance with the underlying physical weighing principle - to the existing acceleration due to gravity at its place of location (only if the balance has not already been adjusted to the location in the factory). This adjustment process must be carried out for the first commissioning, after each change of location as well as in case of fluctuating environment temperature. To receive accurate measuring values it is also recommended to adjust the balance periodically in weighing operation.





Procedure when adjusting:

In calibrated balances the adjustment function is switch locked.















To carry out calibrations, you will have to throw the unlock switch











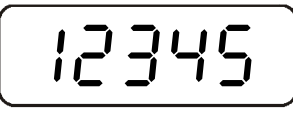

Observe stable environmental conditions. A warming up time (see chapter 1) is required for stabilization. Ensure that there are no objects on the weighing plate.

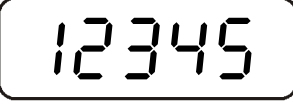
7.6.1 Adjustment of models CXP











Operation	
Ensure that there are no objects on the weighing plate.	
	
Press the  key and keep it pressed down whilst simultaneously operating the  key	
Weight value of adjustment weight is flashing on display. However, you may enter a value of your choice via the number keys. *	
	
Carefully place adjusting weight in the centre of the weighing plate. Adjustment will be carried out automatically after dead stop control.	
Remove adjustment weight during count down to zero.	
The balance returns automatically into weighing mode. An error message will appear on the display should a adjustment error occur or should the adjustment weight be incorrect. Turn balance off, then restart it and repeat the adjustment process.	

7.6.2 Adjustment of models CXB

Operation		
Ensure that there are no objects on the weighing plate.		
The display shows:		
→0← PRE-TARE 	M+ ~ 	M+ ~ 
Press  : If „-----“, is displayed, press  : „01 FnC“ is displayed:		
→0← PRE-TARE 	M+ ~ 	M+ ~ 
↓		
→0← PRE-TARE 		
Press  : „02 EC“ is displayed:		
→0← PRE-TARE 		
Press  : „EC 00“ appears, the first digit flashes:		
→0← PRE-TARE 		
Use numeric key to enter „01“ and confirm by  :		
→0← PRE-TARE 		
↓		

<p>→0← PRE-TARE</p> 		<p>M+ ~</p>  <p>(Example)</p>
<p>Press , then :</p>		
<p>→0← PRE-TARE</p> 		<p>M+ ~</p>  <p>(Example)</p>
<p>The value of the used adjustment weight appears flashing Place the adjustment weight Press  : „EC01“ is displayed, cipher „1“ flashes</p>		
<p>→0← PRE-TARE</p> 		
<p>Take away weight and press </p>		
<p>→0← PRE-TARE</p> 		
<p>Press  anew, herewith the adjustment process is finished.</p>		
<p>→0← PRE-TARE</p> 	<p>M+ ~</p> 	<p>M+ ~</p> 

7.6.3 Adjustment of models CXB_M

Operation		
<p>Ensure that there are no objects on the weighing plate.</p> <p>⇒ Press  + 1 + 5 keys</p> <p>⇒ Press  key</p>		
<p>The display shows:</p>		
		
<p>⇒ Press  key</p>		
<p>The display shows:</p>		
		
<p>Weight value of adjustment weight is flashing on display.</p>		
<p>⇒ Carefully place adjusting weight in the centre of the weighing plate.</p>		
<p>⇒ Press  key</p>		
<p>Adjustment will be carried out automatically after dead stop control.</p> <p>⇒ Remove adjustment weight during count down to zero.</p> <p>The balance returns automatically into weighing mode. An error message will appear on the display should a adjustment error occur or should the adjustment weight be incorrect. Turn balance off, then restart it and repeat the adjustment process.</p>		

* The adjustment should be made with the recommended adjustment weight (see chap. 1 "Technical data"). Weights of different nominal values may be used for adjustment but are not optimal for technical measuring. Info about adjustment weights can be found on the Internet at: <http://www.kern-sohn.com>

8 Verification

General introduction:

According to EU directive 90/384/EEC balances must be verified if they are used as follows (legally controlled area):

- a) For commercial transactions if the price of goods is determined by weighing.
- b) For the production of medicines in pharmacies as well as for analyses in the medical and pharmaceutical laboratory.
- c) For official purposes.
- d) For manufacturing final packages.

In cases of doubt, please contact your local trade in standard.

After verification the balance is sealed at the indicated positions.

Verification of the balance is invalid without the "seal/lead seal".

Verification instructions

An EU type approval exists for balances described in their technical data as verifiable. If a balance is used where obligation to verify exists as described above, it must be verified and re-verified in regular intervals.

Re-verification of a balance is carried out according to the respective national regulations. The validity for verification of balances in Germany is e.g. 2 years.

The legal regulation of the country where the balance is used must be observed!

Balances with obligation to verify must be taken out of operation if:

- The **weighing result** of the balance is outside the **error limit**. Therefore, in regular intervals load balance with known test weight (ca. 1/3 of the max. load) and compare with displayed value.
- The **reverification deadline** has been exceeded.

8.1 Adjustment key and seals

When verification of a scale is finished, the positions indicated on the scale are sealed.

Verification of a scale without a seal is invalid.

Position of seals:

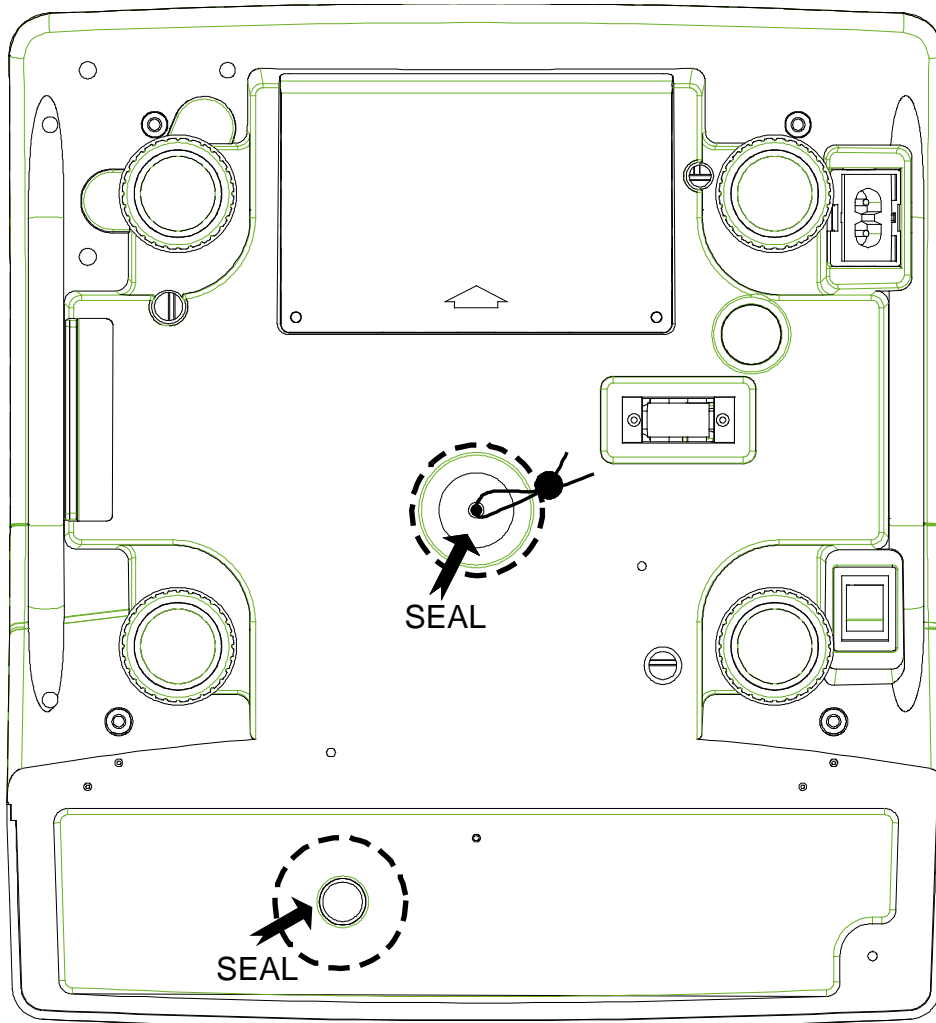
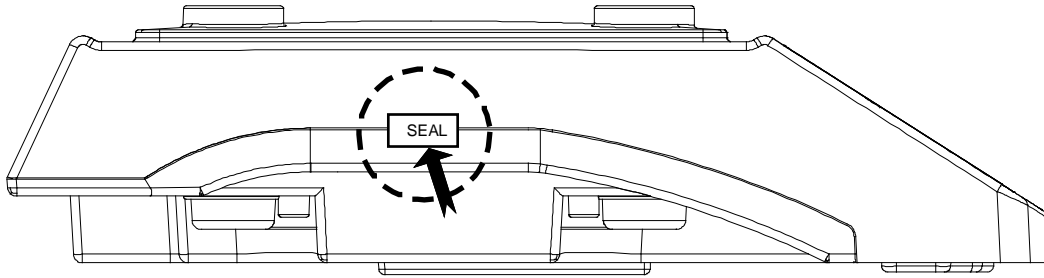

9 Parts counting

With parts counting you can either count parts into a container or remove parts from a container. To count a greater number of parts the average weight per part has to be determined with a small quantity (reference quantity). The larger the reference quantity, the higher the counting exactness. High reference must be selected for small parts or parts with considerably different sizes.

9.1 Determination of the reference weight by weighing

Set balance to zero and tare, as required.



Place a known number of parts on the balance as reference weight



If the "Weight" display is stable, enter the number of parts via number keys.

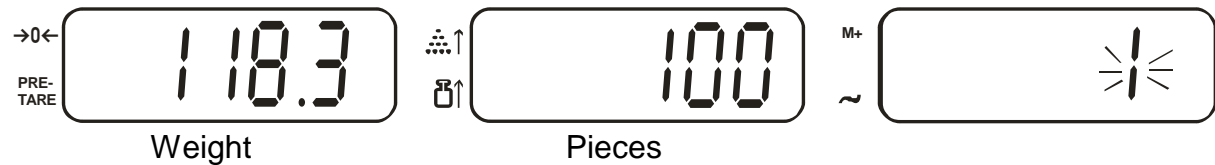

While the "number of pieces" display is flashing (3 sec) confirm by pressing the  key.



Dead stop control is carried out and the calculated reference weight appears on the display.

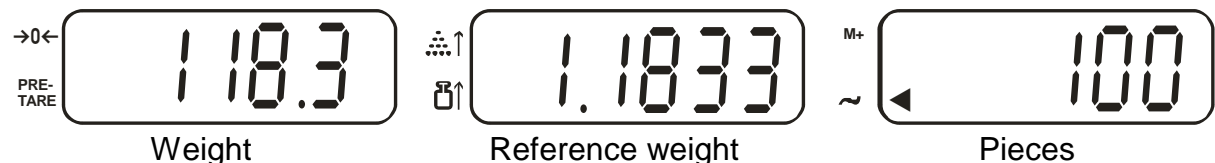

Now you can place the parts to be counted onto the weighing plate.
All quantity parameters of your goods to be weighed are displayed:

9.2 Numeric entering of the reference weight

If you know the reference weight/piece you can enter this via number keys.

Enter reference weight via number keys

Confirm with key

Reference weight

Now you can place the parts to be counted onto the weighing plate. All quantity parameters of your goods to be weighed are displayed:

9.3 Automatic reference optimization

If it was impossible to determine a reference due to instable goods to be weighed or an insufficient reference weight, the [◀] display will appear in the reference weight window during reference calculation.

Overlay ▶ indicates:

	Placed number of pieces insufficient for reference calculation CXB models < 40 d CXP models < 20 d
	Placed reference weight insufficient for reference calculation CXB models < 4/5 d CXP models < 1/5 d

Add additional parts until the [▶] display disappears.



An audio signal indicates that reference optimization has been carried out.

At every reference optimisation, the reference weight is calculated anew. As the additional pieces increase the base for the calculation, the reference also becomes more exact.

9.4 Store/call reference weight

There are 10 memory locations at your disposal (occupied via number keys 0 -9).

9.4.1 Save

Enter the reference weight to be stored		
→0← PRE-TARE 0.0	↑ 100	M+ ~ 0
Press  button		
→0← PRE-TARE PrSet	↑ Set	M+ ~ 0
Press  button		
→0← PRE-TARE PrSet	↑ Set	M+ ~ 0
Enter the storage location for the reference weight via the number keys (0 - 9)		
→0← PRE-TARE 0.0	↑ 100	M+ ~ 0

9.4.2 Call-up

When the reference weight is required at a later point in time it can be called by pressing the  key and entering the relevant storage location number.

Press  button

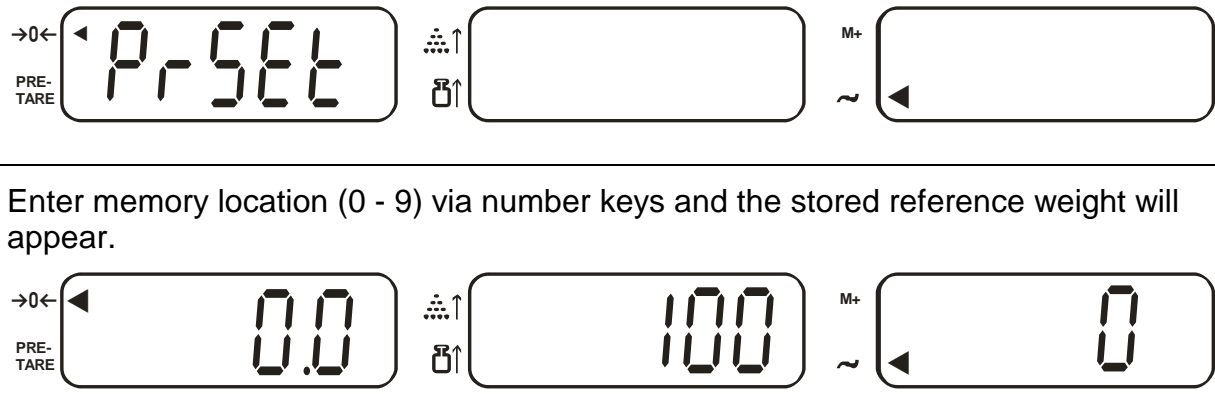

Enter memory location (0 - 9) via number keys and the stored reference weight will appear.

9.5 Count with tolerance control - Fill to target

This function can be used to program a target number of pieces or target weight. Reaching the target value is indicated by an audio-visual signal.

9.5.1 Set tolerance value for target number of pieces

[-0.1g-] is flashing in reference weight window.

Press  button

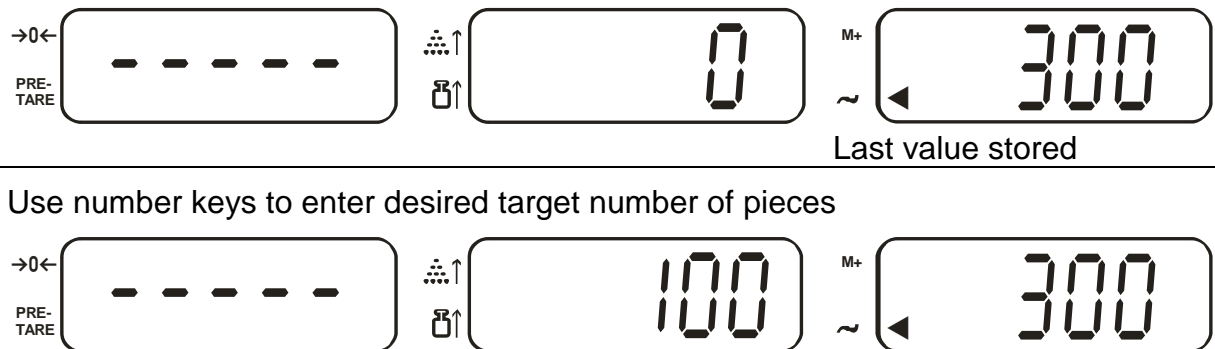

Use number keys to enter desired target number of pieces

Entered target value.
Corrections possible by
pressing  key

Last value stored

Last value stored

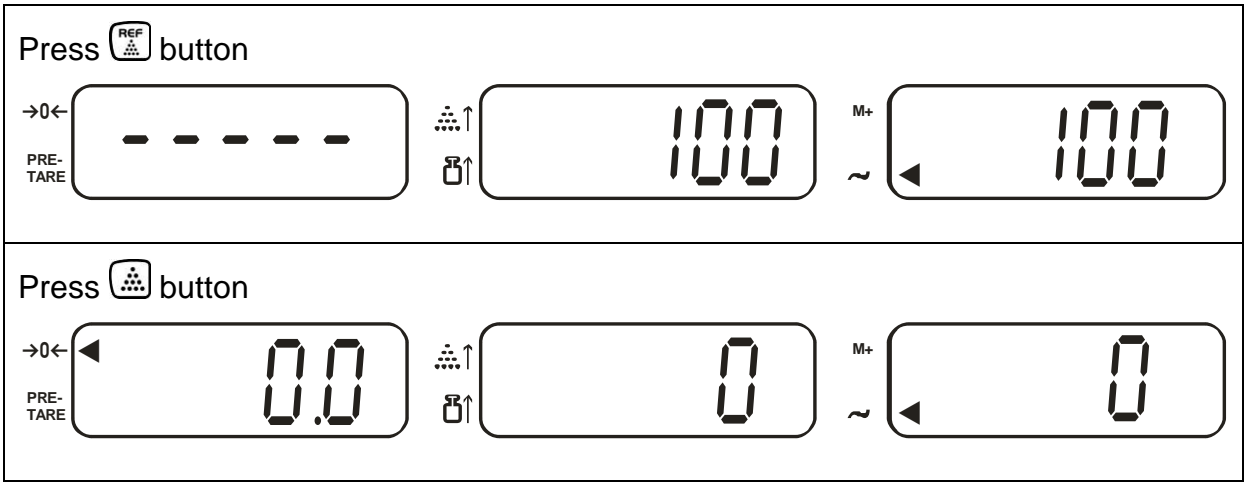

9.5.2 Set tolerance value for target weight

Reaching the target value will be indicated by an audio signal and [-L PSt -] will be flashing in the reference window

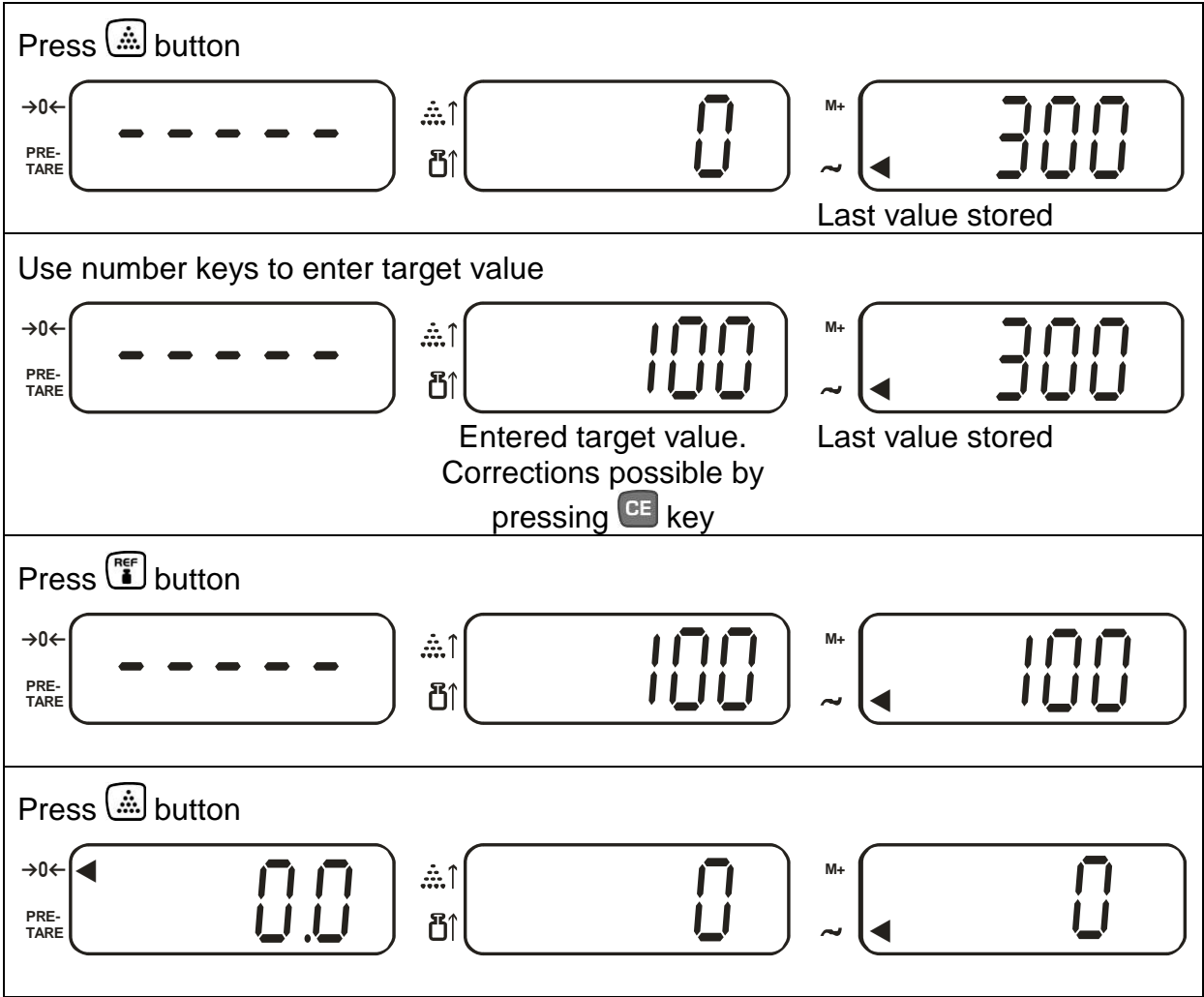

Information:
To delete stored target values enter "0".

10 Taring

The dead weight of any weighing container may be tared away by pressing a button, so that the following weighings show the net weight of the goods to be weighed.

10.1 Determination of the tare weight by weighing

⇒ Place empty tare container on the weighing plate. The total weight of the container is displayed.



⇒ Press  - key



After dead stop control was carried out, the display is reset to "0". The weight of the container is now internally saved. The zero display and the arrow next to the "PRE-TARE" symbol appear.



⇒ Place the goods to be weighed into the tare container. Read the weight of the goods on the display.

Information:

The balance is able to only store one taring value at a time.

When the balance is unloaded the saved taring value is displayed with negative sign.

To delete the stored tare, unload the weighing plate and then press the TARE key; the [◀] display next to "PRE-TARE" disappears.

The taring process can be repeated any number of times. The limit is reached when the whole weighing range is exhausted.

10.2 Numerical input of tare (PRE-TARE)

Pre-setting PRE-TARE mode

(not models CXB-M)

⇒ Press  key, [Enter] appears on the weight display.

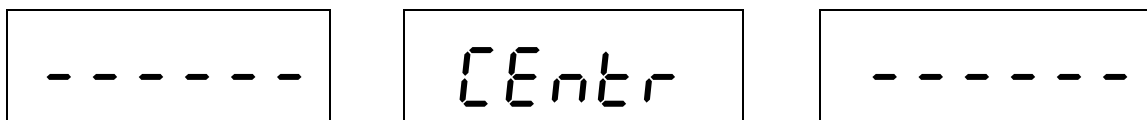

⇒ Press the  key during this display



⇒ Press  button

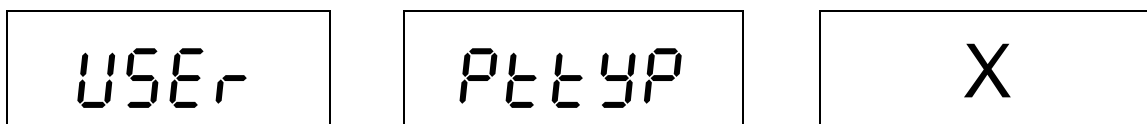

⇒ Use the keys  or  to select the desired setting:

PRE-TARE setting "0" = no input of tare possible when weighing plate is loaded

PRE-TARE setting "1"* = input of tare possible regardless whether weighing plate is loaded or unloaded

* = default setting

PRE-TARE setting „1“:

Objects present on weighing plate.



⇒ Enter your tara weight via number keys.



⇒ Press the  key. The net weight of the goods to be weighed is displayed

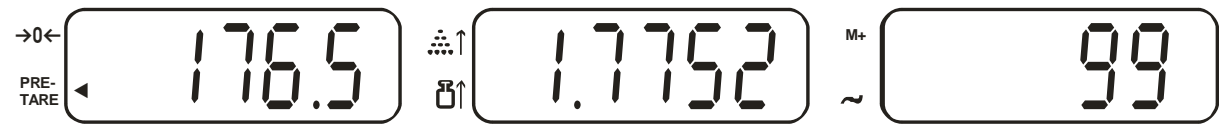

Information:

To delete the stored tare, unload the weighing plate and then press the TARE key; the [◀] display next to "PRE-TARE" disappears.

PRE-TARE setting „0“:

⇒ Remove all objects from weighing plate.



⇒ Press  key



⇒ Enter tare via number keys.



⇒ Press  - key, tare weight is indicated as negative value



⇒ Put on tare container + goods to be weighed. The net weight of the goods to be weighed is displayed

10.3 Numerical input of tare (PRE-TARE)

Modelle CXB-M:

PRE-TARE setting „1“:

Objects present on weighing plate.				
→0← PRE-TARE	177.5	1.7752	M+ ~	100
⇒ Enter your tara weight via number keys.				
→0← PRE-TARE	177.5	1.0	M+ ~	≠177≠
The net weight of the goods to be weighed is displayed				
→0← PRE-TARE	176.5	1.7752	M+ ~	99

Information:

To delete the stored tare, unload the weighing plate and then press the TARE key; the [◀] display next to "PRE-TARE" disappears.

PRE-TARE setting „0“:

Remove all objects from weighing plate.



⇒ Press  - key



⇒ Enter your tara weight via number keys.



⇒ Press  - key, tare weight is indicated as negative value



⇒ Put on tare container + goods to be weighed. The net weight of the goods to be weighed is displayed

11 Add up

The balance is equipped with a summation memory used for adding up of identical counted parts to total quantity and total weight.

11.1 Add up "number parts"

Select reference weight and place number of parts for first weighing.



The display value is added to the summation memory by pressing the **M+** key.



The **[←]** display next to "M+" indicates the stored value. After dead stop control was carried out the balance will return automatically to counting mode.

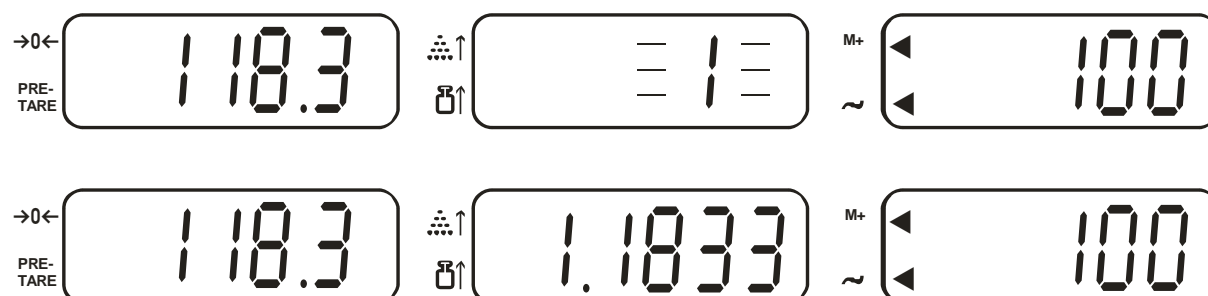

Place number of parts for second weighing and add to memory.

Add and weigh more parts if needed as described above. Please note that the balance must be unloaded between the individual weighing procedures.

This process can be repeated 99 times or until the weighing range of the balance is exhausted.

Display of you saved weighing data:

With balance unloaded, press the **M+** key:

Total weight, number of weighing procedures as well as total parts counting appear 2 sec.

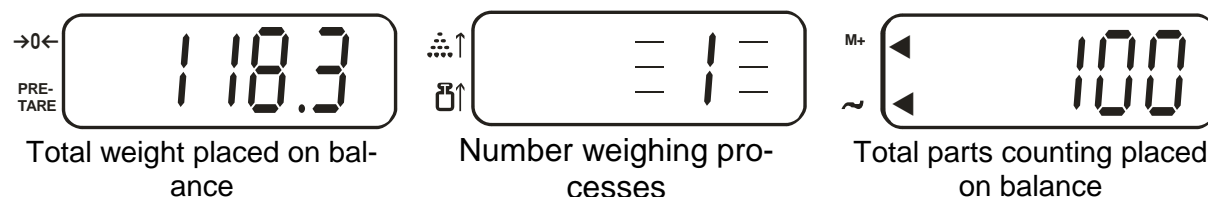

11.2 Add up "weight"

Place weight on weighing plate.



The display value is added to the summation memory by pressing the **M+** key.



The [**◀**] display next to "M+" indicates the stored value. After dead stop control was carried out the balance will return automatically to counting mode.

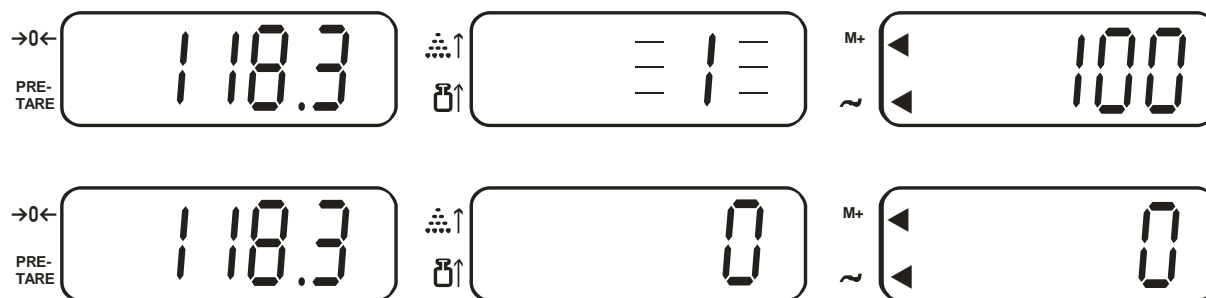

Place goods to be weighed for second weighing and add to memory.

Repeat sequence of operations, as required. Please note that the balance must be unloaded between the individual weighing procedures.

This process can be repeated 99 times or until the weighing range of the balance is exhausted.

Display of you saved weighing data:

With balance unloaded, press the **M+** key:

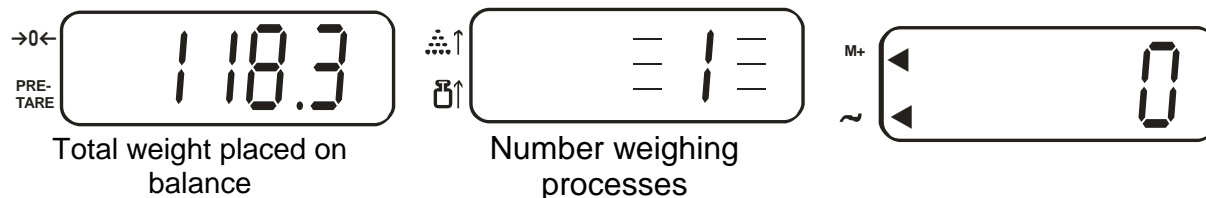

The total weight as well as the number or weighings will pop up for 3 sec.



Information:

Turning off the balance will result in a loss of all stored values.





11.3 Delete stored values

Unload balance and press the  key. Stored values, total weight, total number of pieces and number of weighings will be set to zero. The [] display next to "M+" disappears.

12 Application menu

To adjust the balance to individual requirements, use the application menu to change settings for the balance

12.1 Navigation in the menu

- Press  key, [] appears on the weight display. During this display press the , on the weight display appears [USER].
- To select function, press number keys
- To select parameters, press number keys
- Setting will be imported automatically
- To exit the menu, press the  key

Example: Presetting "PRE-TARE mode":

(not models CXB-M)

Press  key, [] appears on the weight display

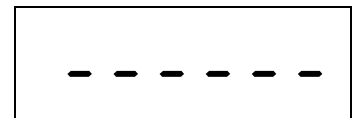
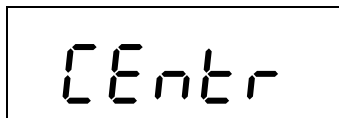
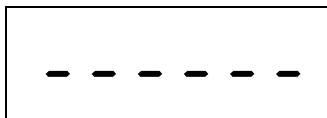

Press the  key during this display

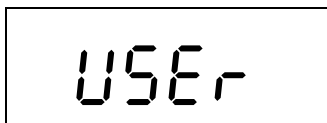

Press  button

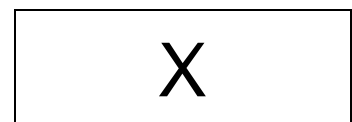
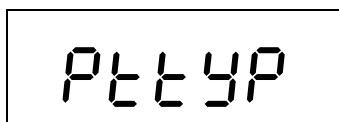
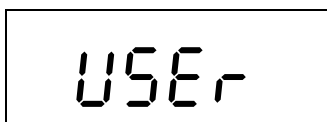





Use the keys  or  to select the desired setting:

PRE-TARE setting "0" = no input of tare possible when weighing plate is loaded

PRE-TARE setting "1"* = input of tare weight possible regardless whether weighing plate is loaded or unloaded

* = default setting

12.2 Menu overview [USER]







Function	Choice		Parameter selection	Description of function
	Key	Display	Key	
Display weighing data in summation memory (Kap.10)	1	nnPLU	0	Weighing data pop up for 3 sec. after  key was pressed
			1	Weighing data remain popped up after  key was pressed until  key is operated
			2	Weighing data will not pop up after  key was pressed, only an audio signal is sounded
PRE-TARE mode (Chpt. 9.2)	2	PttYP	0	Input of tare only possible when weighing plate is unloaded.
			1	Input of tare only possible when weighing plate is loaded.
PRE-TARE mode (Chpt. 8.5)	3	0tYtP	0	Only stable weighing values are allowed for the target number of pieces
			1	All weighing values (stable/instable) are allowed for the target number of pieces
Import weighing value adding up (chap.10)	4	nnPtP	0	M+ for stale weighing values only
			1	M+ for stable/instable weighing values
	5	nnPb0	0	The balance must be reset to zero between individual weighings
			1	The balance needs not to be reset between individual weighings

13 Configurations menu

13.1.1 Display background illumination

(not models CXB-M)

The back light for the display can be adjusted as follows:

	Adjustment	Function
Auto back-light	Press  key, [Enter] appears on the weight display Press the  key during this display.	This display will appear backlit for weight value > 10 d or after key was pressed. When the display moves towards zero, or when the weight value is < 10d, the display will be extinguished 5 seconds later.
Backlight on	Press  key, [Enter] appears on the weight display Press the  key during this display.	Background illumination on. Display rich of contrast which can also be red in the darkness.
Backlight off	Press  key, [Enter] appears on the weight display Press the  key during this display.	Backlight switched off to save battery.

The set mode will remain after the balance was turned off.







13.1.2 Setting the display speed

(not models CXB-M)

You may set values ranging from 01 to 15 as a display speed:

01 = slow and sensitive

15 = fast and insensitive

Adjustment		
Press  key, [Ent] appears on the weight display. Press the 8 key during this display.		
 PRE-TARE 	 	PRE-SET ~  ↓ Display speed Use the 8 key, to increase and the 2 key to decrease the number value
Store setting by using the  key. The balance returns automatically into weighing mode.		

14 Data output (CXP models only)

The balance is typically equipped with a RS 232C interface.

14.1 RS 232C interface

The RS 232C interface allows a bi-directional data exchange from the balance to external devices. This data exchange is asynchronous using ASCII - Code.

Pin allocation of balance output plug:

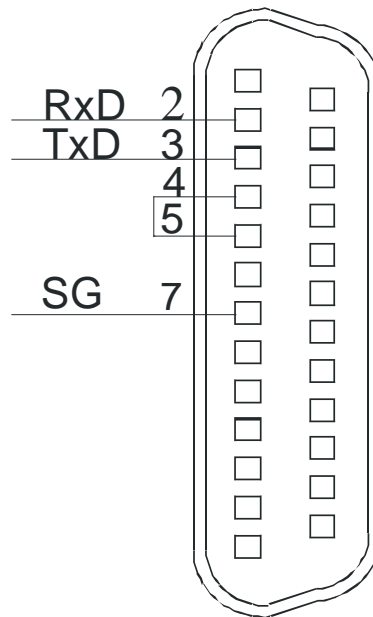

Technical specifications of interface:









Baud rate	9600 ; 4800; 2400;1200
Start bit	0
Stop bit	2 , 1
Parity	nOnE , odd, even
DATA	8 ,7
FLOW	nOnE







Default settings in bold print.

14.2 Description of interface

The selection of a certain operating mode allows you to set the output format, the output control, the transmission speed and the parity bit.

Navigation in the menu:

- Press  key, [L E n t r] appears on the reference weight display. During this display press the  key, on the weight display appears [F U n C t].
- To select function, press number keys
- To select parameters, press number keys:
 -  = up,  = down,  = left,  = right
- Use the  key to store
- To exit the menu, press the  key

Function selection		Parameter selection	Description of function	
Key	Weight display	Display reference weight	Display number of pieces	
	SErLE	LEn b	-	Not documented
		LEn C	-	
	XXX	XXXXX	-	Not documented
	XXX	XXXXX	-	Not documented
	-	dAtE	061210	Setting date
	-	tI n n E	151707 hrs/min/s	Setting time
	St r XX XX = see table 1	-	-	For display format, see also example in chpt. 13.2.1
Confirm setting by pressing the  key, then enter the number of output values (max. 15)				







	St _r XX	X	-	Number of output values X: 0 – F (0-15)	
	Confirm setting X by pressing the  key, then enter settings according to table 2. See also delineation 1 (example for input)				
	St _r XX	40 XX	XXXXXX	Type of output values	
7	IOSEt	PARAL		Not documented	
		r232		RS 232 interface, to be used at all times	
	Confirm setting by pressing the  key, then carry out further settings				
	bAUD	9600			Baud rate
		4800			
		2400			
		1200			
	Confirm setting by pressing the  key, then carry out further settings				
	PARIT	NONE			Parity
		Odd			
		EVEN			
	Confirm setting by pressing the  key, then carry out further settings				
dATA	8			Data bit	
	7				
Confirm setting by pressing the  key, then carry out further settings					
StoP	1			Stop bit	
	2				
Confirm setting by pressing the  key, then carry out further settings					
FLOOR	24045			Always use this setting	
	NONE				
8	SEtC	0		Output after pressing 	
		1		Continuous serial output	
		2		Output after stabilisation (weight >0)	
		3		Output of all weighing values after stabilisation	

Table 1:

Code	Significance
00	Output after pressing M+
0E	Printout header line
01	Printout last line

Table 2:

Code	Description	Pre -character code	End -character code
00	Gross	02	03
01	Tare	04	05
02	Net	06	07
03	Reference weight	08	09
04	Weighing unit	2A	2B
05	Memory #	0C	0D
06	Pieces	0A	0B
07	Stability display		
08	None		
09	User defined input in ASCII Cod#1	11	12
0A	User defined input in ASCII Cod#2	14	15
0B	Decimal point weight	16	17
0C	Decimal point reference weight	18	19
0D	Space line		
0E	Date	22	23
0F	Time	24	25
10	Space line		
11	Total number of pieces	1C	1D
12	User defined input in ASCII Code #1		
13	User defined input in ASCII Code #2		
14	Weight unit of reference weight	20	21
15	None		
16	None		
17	None		
18	None		
19	None		
1A	None		
1B	None		
1C	User defined input in ASCII Code #3	See delineation 1/chpt. 16	
1D	User defined input in ASCII Cod #4		
1E	User defined input in ASCII Cod #5		
1F	User defined input in ASCII Cod #6		

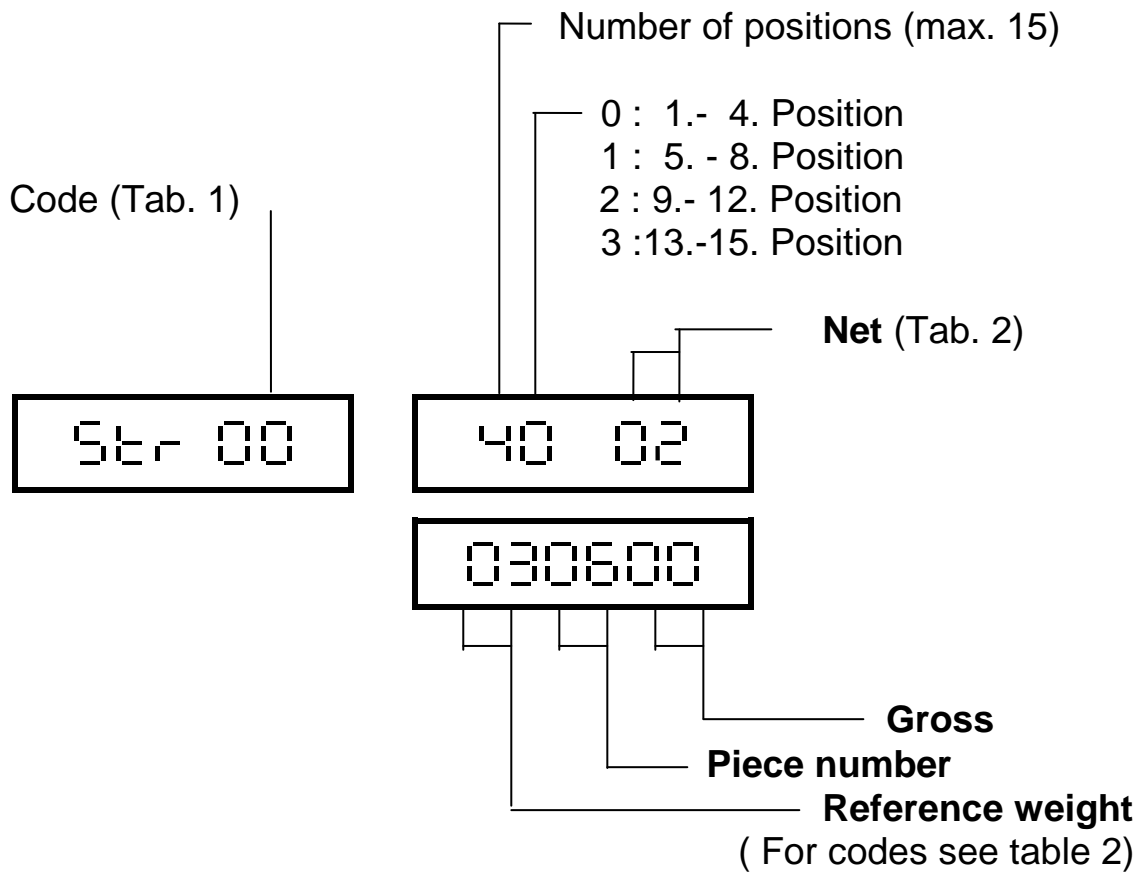

Delineation 1:



Output of this setting:

- ① Net (02)
- ② Reference weight (03)
- ③ Number pcs. (06)
- ④ Gross (00)

14.2.1 Example: Setting an output format

Call up function 6		
Weight	Reference weight	Piece number
5tr XX		
Use number keys 8 , 6 , 4 , 2 to select desired code (XX, see table 1). Example 00 = Output after pressing M+		
5tr 00		
Confirm setting by pressing the  key, reference display is flashing. Set number of output values (e. g. 7) with number keys 8 , 6 , 4 , 2 [0 - F (0-15)], max. 15 values available		
5tr 00	7	
Confirm setting by pressing the  key, first output value in reference weight window is flashing. Set type of first 4 output values with number keys 8 , 6 , 4 , 2 (For code see table 2).		
5tr 00	70 02	040314
	02=Net	04=Weighing unit 03=Reference weight 14=Weight unit Reference
After entering fourth value keep tapping key 6 until fifth value appears. Further values are entered accordingly		
5tr 00	71 05	040314
Confirm setting by pressing the  key		

15 Service, maintenance, disposal

15.1 Cleaning

Before cleaning, please disconnect the appliance from the operating voltage.

Please do not use aggressive cleaning agents (solvents or similar agents), but a cloth dampened with mild soap suds. Ensure that no liquid penetrates into the device and wipe with a dry soft cloth.

Loose residue sample/powder can be removed carefully with a brush or manual vacuum cleaner.

Spilled weighing goods must be removed immediately.

15.2 Service, maintenance

The appliance may only be opened by trained service technicians who are authorized by KERN.

Before opening, disconnect from power supply.

15.3 Disposal

Disposal of packaging and appliance must be carried out by operator according to valid national or regional law of the location where the appliance is used.

16 Instant help

In case of an error in the program process, briefly turn off the balance and disconnect from power supply. The weighing process must then be restarted from the beginning.

Fault	Possible cause
<i>The displayed weight does not glow.</i>	• <i>The balance is not switched on.</i>
	• <i>The mains supply connection has been interrupted (mains cable not plugged in/faulty).</i>
	• <i>Power supply interrupted.</i>
	• <i>Batteries are inserted incorrectly or empty</i>
	• <i>No batteries inserted.</i>
<i>The displayed weight is permanently changing</i>	• <i>Draught/air movement</i>
	• <i>Table/floor vibrations</i>
	• <i>Weighing plate has contact with other objects.</i>
	• <i>Electromagnetic fields / static charging (choose different location/switch off interfering device if possible)</i>
<i>The weighing result is obviously incorrect</i>	• <i>The display of the balance is not at zero</i>
	• <i>Adjustment is no longer correct.</i>
	• <i>Great fluctuations in temperature.</i> <i>Electromagnetic fields / static charging (choose different location/switch off interfering device if possible)</i>

Should other error messages occur, switch balance off and then on again. If the error message remains inform manufacturer.

17 Appendix ASCII CODE table

DEC	HEX	symbol	key
0	00	(ZERO)	Ctrl 2
1	01	_	Ctrl A
2	02		Ctrl B
3	03		Ctrl C
4	04		Ctrl D
5	05		Ctrl E
6	06		Ctrl F
7	07		Ctrl G
8	08		Backspace
9	09		Tab
10	0A		Ctrl J
11	0B		Ctrl K
12	0C		Ctrl L
13	0D		Enter
14	0E		Ctrl N
15	0F		Ctrl O
16	10		Ctrl P
17	11		Ctrl Q
18	12		Ctrl R
19	13		Ctrl S
20	14	↑	Ctrl T
21	15	§	Ctrl U
22	16		Ctrl V
23	17		Ctrl W
24	18		Ctrl X
25	19		Ctrl Y
26	1A		Ctrl Z
27	1B		Esc
28	1C		Ctrl \
29	1D		Ctrl]
30	1E		Ctrl 6
31	1F		Ctrl -
32	20		SPACE BAR
33	21	!	!
34	22	“	“
35	23	#	#
36	24	\$	\$
37	25	%	%

DEC	HEX	symbol	key
38	26	&	&
39	27	'	'
40	28	((
41	29))
42	2A	*	*
43	2B	+	+
44	2C	,	,
45	2D	-	-
46	2E	.	.
47	2F	/	/
48	30	0	0
49	31	1	1
50	32	2	2
51	33	3	3
52	34	4	4
53	35	5	5
54	36	6	6
55	37	7	7
56	38	8	8
57	39	9	9
58	3A	:	:
59	3B	;	;
60	3C	<	<
61	3D	=	=
62	3E	>	>
63	3F	?	?
64	40	@	@
65	41	A	A
66	42	B	B
67	43	C	C
68	44	D	D
69	45	E	E
70	46	F	F
71	47	G	G
72	48	H	H
73	49	I	I
74	4A	J	J
75	4B	K	K

DEC	HEX	symbol	key
76	4C	L	L
77	4D	M	M
78	4E	N	N
79	4F	O	O
80	50	P	P
81	51	Q	Q
82	52	R	R
83	53	S	S
84	54	T	T
85	55	U	U
86	56	V	V
87	57	W	W
88	58	X	X
89	59	Y	Y
90	5A	Z	Z
91	5B	[[
92	5C	\	\
93	5D]]
94	5E	^	^
95	5F	_	_
96	60	`	`
97	61	a	a
98	62	b	b
99	63	c	c
100	64	d	d
101	65	e	e
102	66	f	f
103	67	g	g
104	68	h	h
105	69	i	i
106	6A	j	j
107	6B	k	k
108	6C	l	l
109	6D	m	m
110	6E	n	n
111	6F	o	o
112	70	p	p
113	71	q	q
114	72	r	r
115	73	s	s

DEC	HEX	symbol	key
116	74	t	t
117	75	u	u
118	76	v	v
119	77	w	w
120	78	x	x
121	79	y	y
122	7A	z	z
123	7B	{	{
124	7C		
125	7D	}	}
126	7E	~	~
127	7F	Δ	Ctrl ←
128	80	Ç	Alt 128
129	81	ü	Alt 129
130	82	é	Alt 130
131	83	â	Alt 131
132	84	ä	Alt 132
133	85	à	Alt 133
134	86	å	Alt 134
135	87	ç	Alt 135
136	88	ê	Alt 136
137	89	ë	Alt 137
138	8A	è	Alt 138
139	8B	ï	Alt 139
140	8C	î	Alt 140
141	8D	ì	Alt 141
142	8E	Ä	Alt 142
143	8F	Å	Alt 143
144	90	É	Alt 144
145	91	æ	Alt 145
146	92	Æ	Alt 146
147	93	ô	Alt 147
148	94	ö	Alt 148
149	95	ò	Alt 149
150	96	û	Alt 150
151	97	ù	Alt 151
152	98	ÿ	Alt 152
153	99	Ö	Alt 153
154	9A	Ü	Alt 154
155	9B	ç	Alt 155

DEC	HEX	symbol	key
156	9C	£	Alt 156
157	9D	¥	Alt 157
158	9E	Ɔ	Alt 158
159	9F	ƒ	Alt 159
160	A0	á	Alt 160
161	A1	í	Alt 161
162	A2	ó	Alt 162
163	A3	ú	Alt 163
164	A4	ñ	Alt 164
165	A5	Ñ	Alt 165
166	A6	ª	Alt 166
167	A7	º	Alt 167
168	A8	¿	Alt 168
169	A9	¬	Alt 169
170	AA	¬	Alt 170
171	AB	½	Alt 171
172	AC	¼	Alt 172
173	AD	¡	Alt 173
174	AE	«	Alt 174
175	AF	»	Alt 175
176	B0	¡	Alt 176
177	B1	¡	Alt 177
178	B2	¡	Alt 178
179	B3	¡	Alt 179
180	B4	‡	Alt 180
181	B5	‡	Alt 181
182	B6	‡	Alt 182
183	B7	‡	Alt 183
184	B8	‡	Alt 184
185	B9	‡	Alt 185
186	BA	‡	Alt 186
187	BB	‡	Alt 187
188	BC	‡	Alt 188
189	BD	‡	Alt 189
190	BE	‡	Alt 190
191	BF	‡	Alt 191
192	C0	⌞	Alt 192
193	C1	⌞	Alt 193
194	C2	⌞	Alt 194
195	C3	⌞	Alt 195

DEC	HEX	symbol	key
196	C4	—	Alt 196
197	C5	†	Alt 197
198	C6	‡	Alt 198
199	C7	‡	Alt 199
200	C8	‡	Alt 200
201	C9	‡	Alt 201
202	CA	‡	Alt 202
203	CB	‡	Alt 203
204	CC	‡	Alt 204
205	CD	=	Alt 205
206	CE	‡	Alt 206
207	CF	‡	Alt 207
208	D0	‡	Alt 208
209	D1	‡	Alt 209
210	D2	‡	Alt 210
211	D3	‡	Alt 211
212	D4	‡	Alt 212
213	D5	‡	Alt 213
214	D6	‡	Alt 214
215	D7	‡	Alt 215
216	D8	‡	Alt 216
217	D9	‡	Alt 217
218	DA	‡	Alt 218
219	DB	‡	Alt 219
220	DC	—	Alt 220
221	DD	‡	Alt 221
222	DE	‡	Alt 222
223	DF	—	Alt 223
224	E0	a	Alt 224
225	E1	ß	Alt 225
226	E2	G	Alt 226
227	E3	p	Alt 227
228	E4	S	Alt 228
229	E5	s	Alt 229
230	E6	µ	Alt 230
231	E7	t	Alt 231
232	E8	F	Alt 232
233	E9	T	Alt 233
234	EA	O	Alt 234
235	EB	d	Alt 235

DEC	HEX	symbol	key
236	EC	8	Alt 236
237	ED	f	Alt 237
238	EE	e	Alt 238
239	EF	n	Alt 239
240	F0	=	Alt 240
241	F1	±	Alt 241
242	F2	=	Alt 242
243	F3	=	Alt 243
244	F4	(Alt 244
245	F5)	Alt 245

DEC	HEX	symbol	key
246	F6	÷	Alt 246
247	F7	~	Alt 247
248	F8	°	Alt 248
249	F9	•	Alt 249
250	FA	.	Alt 250
251	FB	v	Alt 251
252	FC	n	Alt 252
253	FD	²	Alt 253
254	FE		Alt 254
255	FF	(blank)	Alt 255