

Specifications

Insulation Resistance: 1,000MΩ min. at 500V DC
 Dielectric Withstanding Voltage: 700V AC for 1 minute
 Contact Resistance: 30mΩ max. at 10mA/20mV max.
 Operating Temperature Range: -40°C to +150°C (type PSF)
 -55°C to +170°C (type PES & PEI)
 Mating Cycles: 10,000 insertions min.

Materials and Finish

Housing: Polysulphone (PSF), glass-filled
 Polyethersulphone (PES), glass-filled
 Polyetherimide (PEI), glass-filled
 Contacts: Beryllium Copper (BeCu)
 Plating: Gold over Nickel

Part Number (Details)

IC51 - 008 2 - 1024 - MF

Series No.

No. of Contact Pins

No. of Sides with Contacts

Design Number

MF= Flanged

Unmarked = Not Flanged

Applicable Dimensions (Reference Only)

Example of a SOP Socket

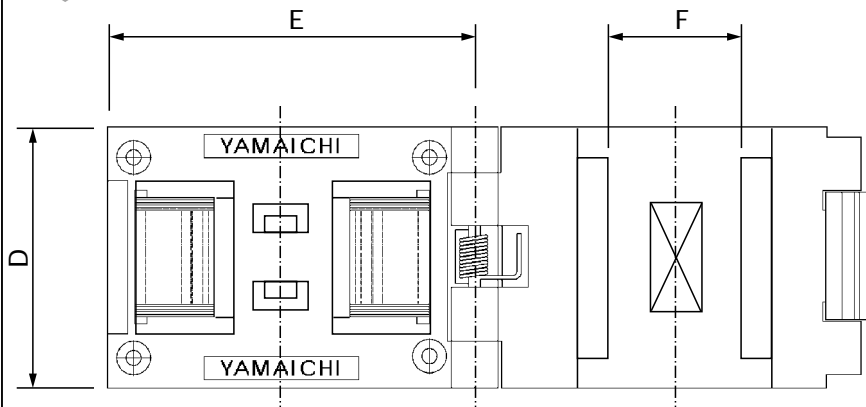

Outline IC Dimensions

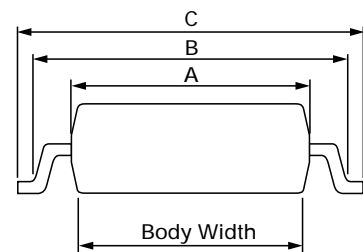

A = Body width (max.)

B = Also the lid size for IC

C = Tip-to-Tip

F = Lid size from Socket

SOP Clamshell

Part Number	Pin Count	Pitch (mm)	Matching IC Dim.				Note	Socket Dimensions		
			Body Width	A(max)	B(max)	C(nom.)		D	E	F
IC51-0082-1024	8	1.27	5.2	5.25	7.2	7.9	FB	18.5	32.5	7.2
IC51-1035.KS10460	8	1.27	4.0	4.0	5.4	6.0	S	22.0	27.2	5.4
IC51-0112-1836	12	0.80	4.4	4.5	5.2	5.9	S	24.0	27.5	5.2
IC51-0142-951	14	1.25	4.4	4.5	5.2	5.9	S	24.0	27.5	5.2
IC51-0142-084	14	1.27	4.4	4.5	5.7	6.5	S	22.0	25.0	5.7
IC51-0142-1013	14	1.27	5.2	5.25	7.2	7.9	FB	18.5	32.5	7.2
IC51-1035.KS-15187	14	1.27	4.0	4.0	5.2	6.0	S	22.0	27.2	5.4
IC51-0162-1035	16	1.27	4.0	4.0	5.2	6.0	S	22.0	27.2	5.4
IC51-0162-1042	16	1.27	4.0	4.2	5.4	6.2	S	22.0	27.2	5.4
IC51-0162-658	16	1.27	4.4	4.5	6.2	7.0	S	26.0	31.5	5.7
IC51-0162-271-2	16	1.27	5.0	5.0	5.2	6.0	S	13.0	26.5	5.22
IC51-0162-273-2	16	1.27	5.0	5.0	6.2	7.0	S	13.0	26.5	6.22
IC51-0162-1025	16	1.27	5.2	5.25	7.2	7.9	FB	18.5	32.5	7.2
IC51-0162-271-1	16	1.27	5.5	5.0	5.2	6.0	S	13.0	26.5	5.22
IC51-0162-272-1	16	1.27	5.5	5.5	5.7	6.5	S	13.0	26.5	5.72
IC51-0162-273-1	16	1.27	5.5	5.5	6.22	7.0	S	13.0	26.5	6.22
IC51-0162-902-2	16	1.27	5.3	5.35	7.2	8.2	S	12.0	28.5	7.2
IC51-347.KS-7704	16	1.27	7.7	7.7	9.5	10.3	S	16.0	31.5	9.53
IC51-347.KS-6768	18	1.27	7.7	7.7	9.5	10.3	S	16.0	31.5	9.53
IC51-347.KS-13574	20	1.27	7.5	7.6	9.4	10.3	S	18.0	32.0	9.3

Note:

Sockets with (S) "Separator" can accept and properly align lower pin count devices.

Sockets with (FB) "Floating Base" will only accept devices with the same pin count as the socket.

IC51 - Clamshell

Small Outline Package (SOP)

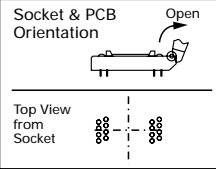

Recommended PCB Layouts (8 - 14 pins)

8 pins (SOP)

IC51-0082-1024

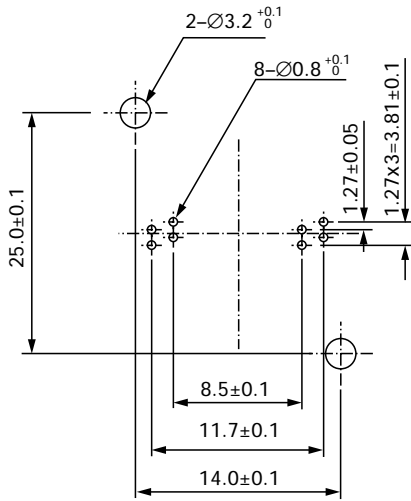

14 pins (SOP)

IC51-0142-1013

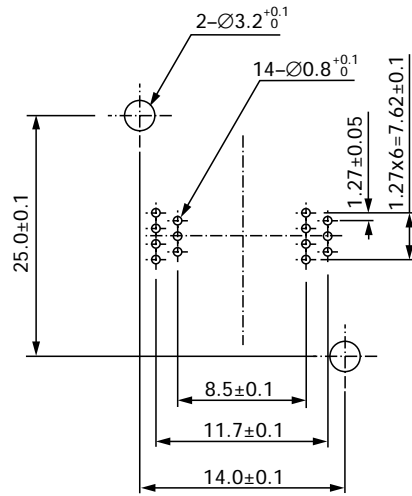

12 pins (SOP)

IC51-0122-1836

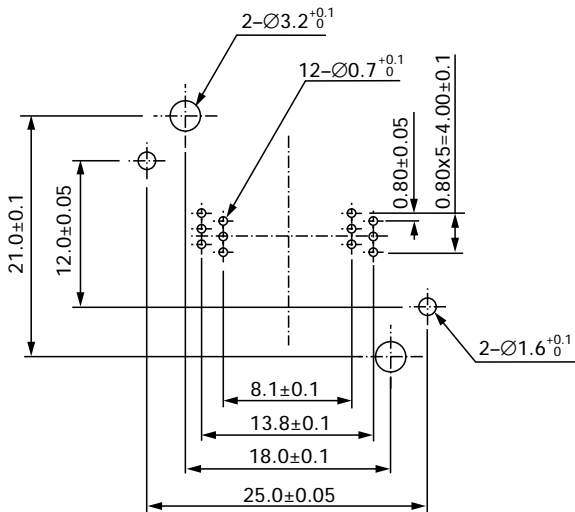

14 pins (SOP)

IC51-0142-951

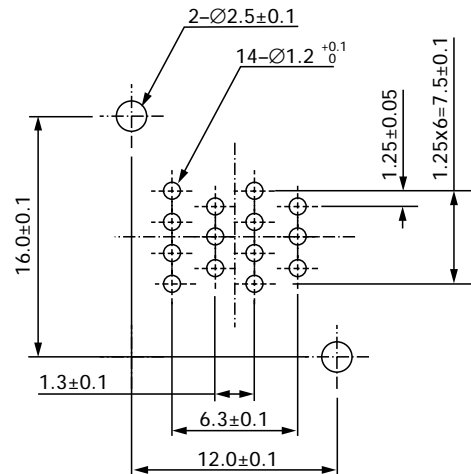

14 pins (SOP)

IC51-0142-084

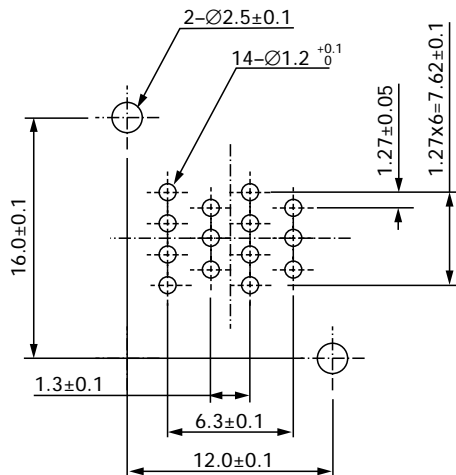

14 pins (SOP)

IC51-1035.KS-15187

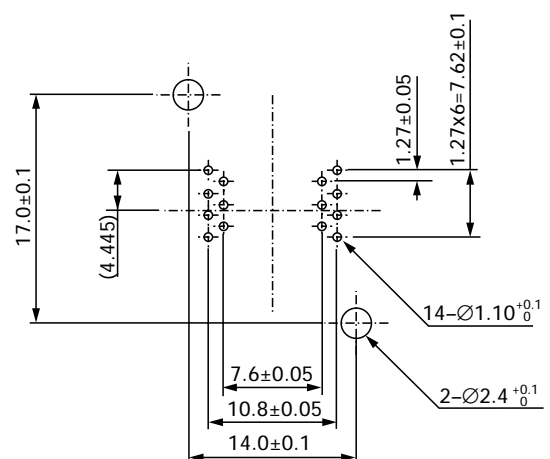

IC51 - Clamshell

Small Outline Package (SOP)

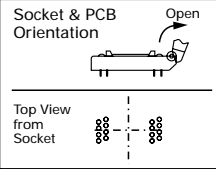

Recommended PCB Layouts (8-16 pins)

16 pins (SOP)

IC51-0162-658

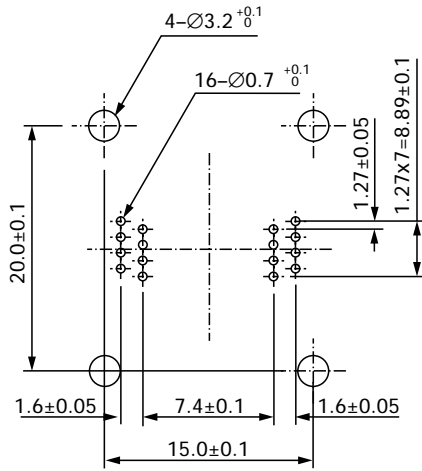

16 pins (SOP)

IC51-0162-271-1

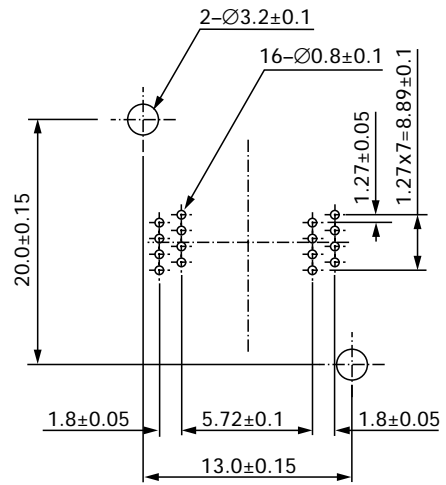

16 pins (SOP)
8 pins (SOP)

IC51-0162-1035
IC51-1035.KS-10460

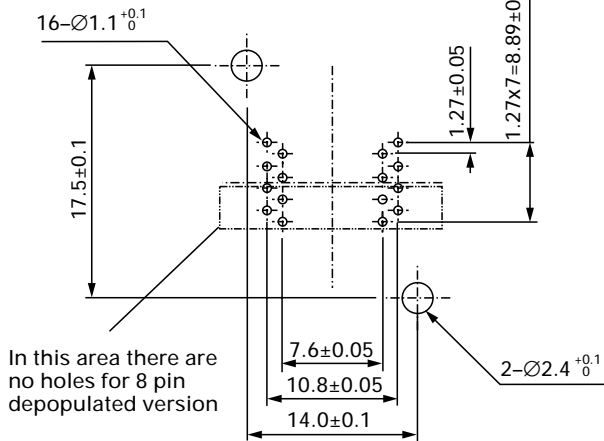

16 pins (SOP)

IC51-0162-271-2

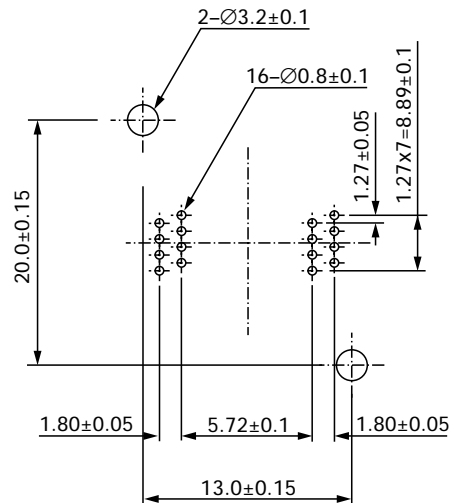

16 pins (SOP)

IC51-0162-1042

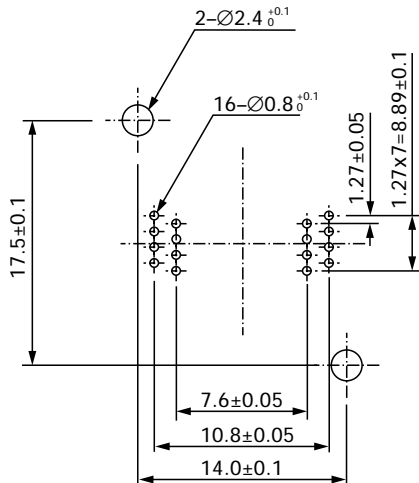

16 pins (SOP)

IC51-0162-272-1

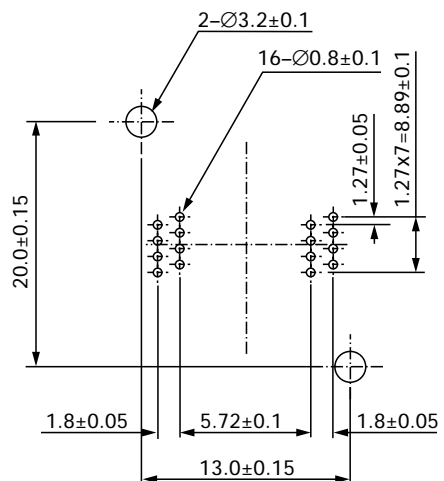

IC51 - Clamshell

Small Outline Package (SOP)

Socket & PCB Orientation

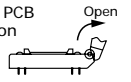

Top View from Socket

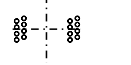

Recommended PCB Layouts (16-20 pins)

16 pins (SOP) IC51-0162-273-1

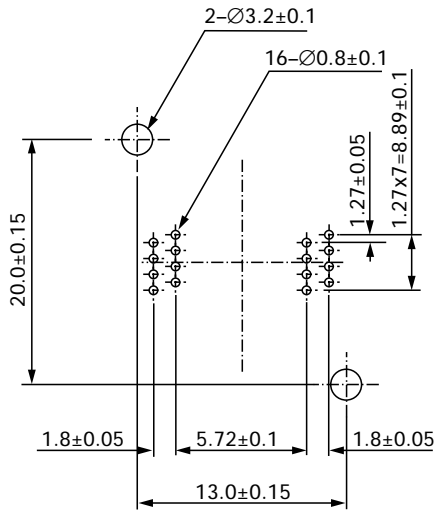

16 pins (SOP) IC51-347.KS-7704

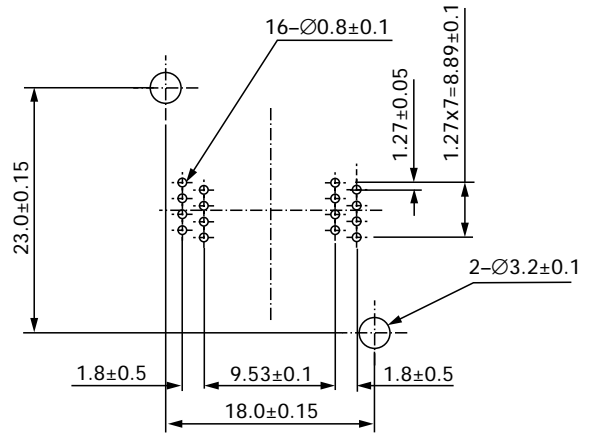

16 pins (SOP) IC51-0162-902-2

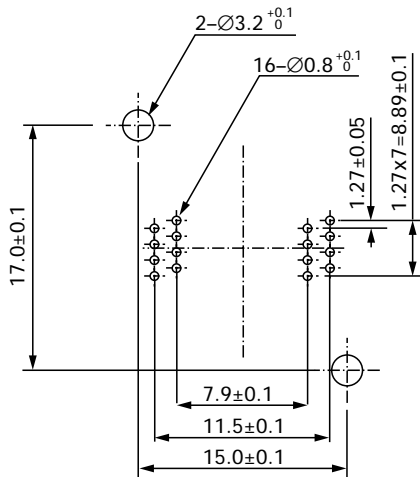

18 pins (SOP) IC51-0347.KS-6768

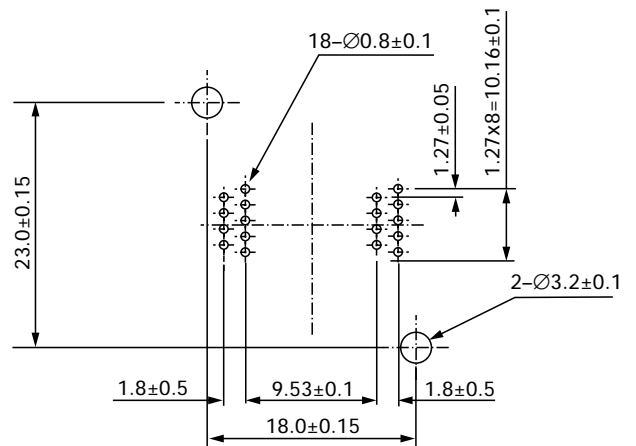

16 pins (SOP) IC51-0162-1025

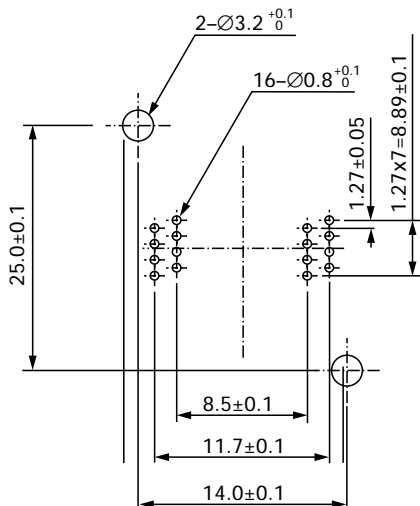

20 pins (SOP) IC51-334.KS-13574

