

Surface contact / tube contact temperature measuring transducers, including strap, compact variant, calibratable, with multi-range switching and active outputg (Automatic Output Switching)

ALTM 1

Patented quality product (patent no. DE 10 2015 015 941 B4)

Calibratable surface-contact temperature measuring transducer **THERMASGARD® ALTM 1**, with eight switchable measuring ranges (max. -20...+150 °C), active output, compact variant incl. strap, housing made from impact-resistant plastic with quick-release screws, with cable gland or M12 connector according to DIN EN 61076-2-101, optionally with /without display. The standard display can be changed from SI [°C] to imperial [°F] units via DIP switch.

The measuring transducer converts the measured variables into a standard signal of 0- 10 V or 4...20 mA. The unit with **Automatic Output Switching** (AOS variant) detects the required output type and automatically switches to U or I output. Alternatively, a **type version** (2-wire I variant) with 2-wire connection and I output is available.

The surface-contact sensor is used to detect the temperature on lines, pipes (e.g., cold and warm water) or on heating sections for heating control. The sensor is factory-calibrated; an environmental precision adjustment by an expert is possible.



TECHNICAL DATA

ALTM 1 - I

Power supply:	15...36 V DC, depending on working resistance, residual ripple stabilised ± 0.3 V
Working resistance:	$R_a \text{ (Ohm)} = (U_b - 14 \text{ V}) / 0.02 \text{ A}$
Connection type:	2-wire connection
Output:	4...20 mA

ALTM 1 - A (AOS)

Power supply:	24 V AC / DC (± 10 %)
Load resistance:	$R_L = 25...450 \text{ Ohm}$ with AOS I variant $R_L > 15 \text{ kOhm}$ with AOS U variant
Connection type:	3-wire connection
Output:	automatic 0-10 V / 4...20 mA (via Automatic Output Switching – the unit detects the required output type and automatically switches to U or I output)

GENERAL

Power consumption:	< 1.0 VA / 24 V DC; < 2.2 VA / 24 V AC
System of units:	SI (default) or Imperial (switchable via DIP switch)
Data points:	Temperature [°C] [°F]
Measuring ranges:	multi-range switching with 8 measuring ranges , see table (other ranges optional) T_{max} up to +100 °C , operating range -50...+100 °C with manual zero point correction (± 10 K)
Sensor:	Pt1000, DIN EN 60751, class B (Perfect Sensor Protection)
Deviation, temperature:	typically ± 0.2 K at +25 °C
Insulating resistance:	≥ 100 MΩ, at +20 °C (500 V DC)
Housing:	plastic, UV-resistant, material polyamide, 30 % glass-globe reinforced, with quick-release screws (slotted / Phillips head combination), colour traffic white (similar to RAL 9016), cover for display is transparent!
Housing dimension:	72 x 64 x 37.8 mm (Tyr 1 without display) 72 x 64 x 43.3 mm (Tyr 1 with display)
Cable connection:	cable gland , plastic (M 16 x 1.5; with strain relief, exchangeable, max. inner diameter 10.4 mm) or M12 connector (male, 5-pin, A-code) according to DIN EN 61076-2-101
Electrical connection:	0.14 - 1.5 mm², via terminal screws
Process connection:	endless strap with metal tightener, (included in the scope of delivery) Ø = 13 - 92 mm (¼ - 3"), length L = 300 mm
Ambient temperature:	measuring transducer -30...+70 °C
Permissible humidity:	< 95 % RH, non-precipitating air
Protection class:	III (according to EN 60 730)
Protection type:	IP65 (according to EN 60 529) Housing tested, TÜV SÜD, Report No.713139052 (Tyr 1)
Standards:	CE conformity, electromagnetic compatibility according to EN 61326, according to EMC directive 2014 / 30 / EU
Optional:	two-line display with illumination , cutout approx. 36 x 15 mm (W x H), for displaying the ACTUAL temperature and the internal diagnostics (sensor breakage, sensor short circuit)

ACCESSORIES (see table)

Display and internal diagnostics
THERMASGARD®
Measuring transducer with display

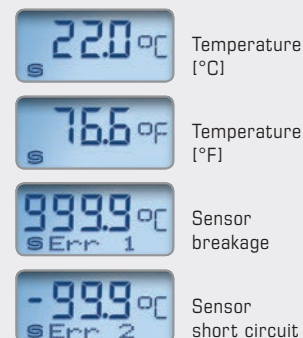



NEW

Surface contact / tube contact temperature measuring transducers, including strap, compact variant, calibratable, with multi-range switching and active output (Automatic Output Switching)

Dimensional drawing [mm]

ALTM 1

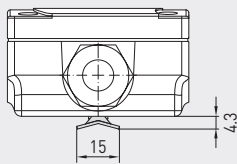
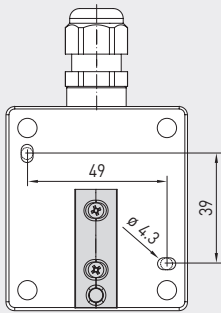

without display

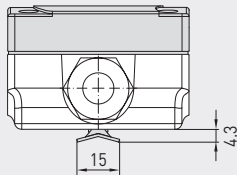
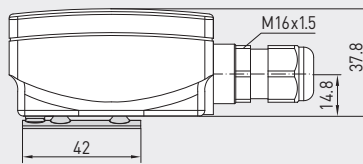

with display

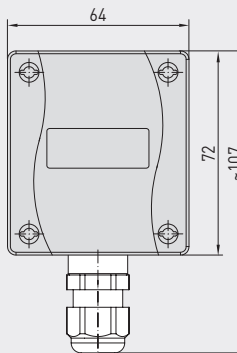
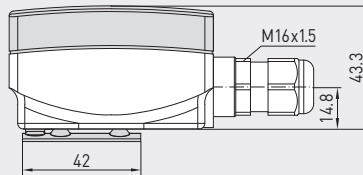

M12 connector (optional on request)

ALTM 1 with display



High-performance encapsulation against vibration, mechanical stress and humidity



Automatic detection and switching to standard signal 0...10V or 4...20 mA



Surface contact / tube contact temperature measuring transducers, including strap, compact variant, calibratable, with multi-range switching and active output (Automatic Output Switching)

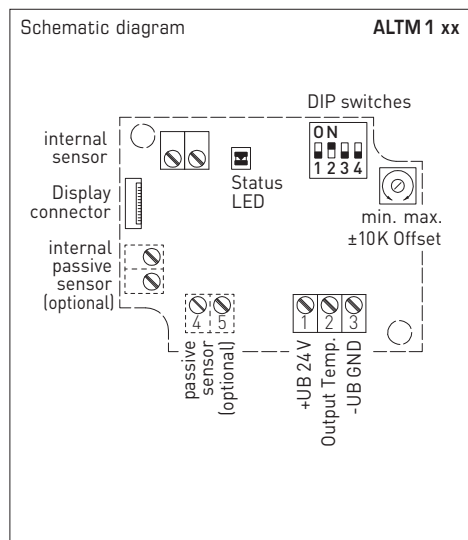

2-wire connection* ALTM 1 - I

- 1 +UB 24V DC
- 2 Output Temp. 4...20mA
- 3 -UB GND (optional for backlighting)

* 2-wire connection for devices with / without display (not illuminated)
3-wire connection for devices with illuminated display

3-wire connection (AOS) ALTM 1 - A

- 1 +UB 24V AC/DC
- 2 Output Temp. 0-10V / 4...20mA
- 3 -UB GND

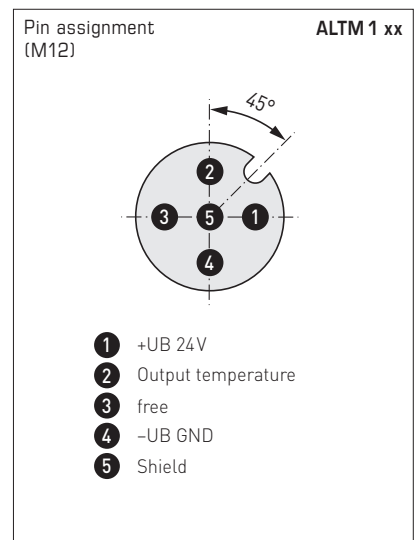

Measuring ranges [°C] (adjustable)	DIP 1	DIP 2	DIP 3
-20...+ 150 °C	ON	ON	ON
-50... + 50 °C	OFF	ON	ON
-20... + 80 °C	ON	OFF	ON
-30... + 60 °C	OFF	OFF	ON
0... + 40 °C	ON	ON	OFF
0... + 50 °C (default)	OFF	ON	OFF
0... + 100 °C	ON	OFF	OFF
0... + 150 °C	OFF	OFF	OFF

Display (switchable)	DIP 4
Imperial [°F]	ON
SI (default) [°C]	OFF

Display
Temperature [°C] → [°F]

The display value depends on the set unit system (DIP4).

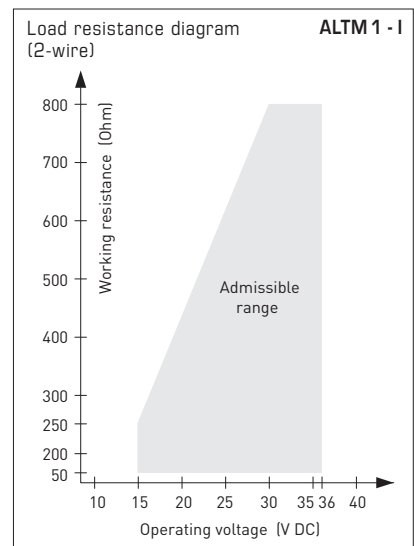

For further technical information, see the operating instructions



NEW

Surface contact / tube contact temperature measuring transducers, including strap, compact variant, calibratable, with multi-range switching and active output (Automatic Output Switching)

ALTM 1 - Q
with M12 connector
(on request)

ALTM 1
with cable gland



THERMASGARD® ALTM 1		Surface contact / tube contact temperature measuring transducers (compact variant)			
Type / WG01	Output	Type	Display	Item No.	Price
ALTM 1 - I (2-wire)					
ALTM1-I	4...20 mA	compact		1101-1112-0219-920	108,18 €
ALTM1-I LCD	4...20 mA	compact	■	1101-1112-2219-920	160,64 €
ALTM 1 - A (3-wire AOS)					
ALTM1-A	0-10 V / 4...20 mA	compact		1101-111E-0219-920	108,18 €
ALTM1-A LCD	0-10 V / 4...20 mA	compact	■	1101-111E-2219-920	160,64 €
Automatic Output Switching (AOS):	Patented analogue interface (patent no. DE 10 2015 015 941 B4) Unit automatically detects the required output type 0-10 V or 4...20 mA.				
Extra charge:	Other ranges optional Cable connection with M12 connector according to DIN EN 61076-2-101				26,16 € on request

ACCESSORIES			
WLP-1	Heat-conductive paste, silicone-free		7100-0060-1000-000 4,79 €
Special accessories for M12 connector see chapter Accessories!			

