



Brand of NTN corporation

## Technical data

### 62202EEC3

Single row deep groove ball bearings



Deep groove ball bearing, radial contact, pressed steel cage, contact seals on both sides

### VISUAL (S)

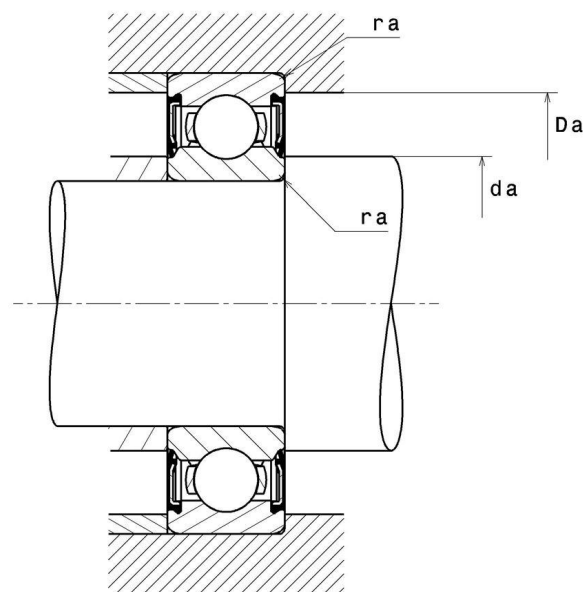
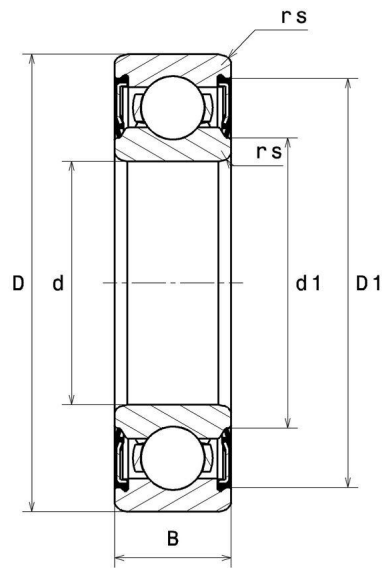

**NTN Europe**

1 rue des Usines · BP 2017 · 74010 Annecy Cedex · France · Tel. +33 (0)4 50 65 30 00  
S.A. au capital de 322 639 919 € · RCS ANNECY B 325 821 072 · Id. Fiscale : FR 48 325 821 072  
SIRET 325 821 072 00015 · Code APE 2815 Z · Code NACE 28.15

# 62202EEC3

Single row deep groove ball bearings

## PRODUCT DEFINITION

<b>Brand</b>	SNR
<b>d - Internal diameter</b>	15 mm
<b>D - External diameter</b>	35 mm
<b>B - Bearing/Inner ring width</b>	14 mm
<b>d1 - External diameter inner ring</b>	21,1 mm
<b>D1 - Inner diameter outer ring</b>	30,5 mm
<b>rs - Min fillet radius</b>	0,6 mm
<b>Radial clearance class</b>	C3
<b>Mass</b>	0,056 kg

## PRODUCT PERFORMANCE

<b>C - Dynamic load</b>	8100000 mN
<b>C0 - Static load</b>	3750000 mN
<b>Cu - Fatigue limit load</b>	170000 mN
<b>f0 - Coefficient</b>	13.1
<b>N lim - Mechanical Limit Speed</b>	84000 °/s
<b>Tmin - Min operating temperature</b>	243,15 °K
<b>Tmax - Max operating temperature</b>	393,15 °K

## BEARING FREQUENCIES

<b>BPFO - Over rolling frequency on outer ring (60 rpm)</b>	3.048 Hz
<b>BPFI - Over rolling frequency on inner (60 rpm)</b>	4.952 Hz
<b>BSF - Over rolling frequency on rolling element (60 rpm)</b>	3.962 Hz
<b>BRF - Rotational frequency - rolling element (60 rpm)</b>	1.981 Hz
<b>FTF - Rotational frequency - cage (60 rpm)</b>	0.381 Hz



**NTN Europe**

1 rue des Usines · BP 2017 · 74010 Annecy Cedex · France · Tel. +33 (0)4 50 65 30 00  
S.A. au capital de 322 639 919 € · RCS ANNECY B 325 821 072 · Id. Fiscale : FR 48 325 821 072  
SIRET 325 821 072 00015 · Code APE 2815 Z · Code NACE 28.15

## ABUTMENT

<b>da min - Min shoulder diameter IR</b>	19 mm
<b>da max - Max shoulder diameter IR</b>	21,1 mm
<b>Da max - Max shoulder diameter OR</b>	31 mm
<b>ra max - Max shaft &amp; housing fillet radius</b>	0,6 mm

## INDUSTRY CALCUL FACTORS

## Equivalent dynamic radial load

$$P = X \cdot Fr + Y \cdot Fa$$

$\frac{f_0 F_a}{C_0}$	e	Fa / Fr ≤ e		Fa / Fr > e	
		X	Y	X	Y
0.172	0.19	1	0	0.56	2.3
0.345	0.22				1.99
0.689	0.26				1.71
1.03	0.28				1.55
1.38	0.3				1.45
2.07	0.34				1.31
3.45	0.38				1.15
5.17	0.42				1.04
6.89	0.44				1

## Equivalent static radial load

$$P_0 = X_0 \cdot Fr + Y_0 \cdot Fa$$

$X_0$	$Y_0$
0.6	0.5

For single or DT bearing arrangement :

If  $P_0 < Fr$ , then use  $P_0 = Fr$

