

# Datasheet

## 6.3 x 32mm T Cartridge Fuse, 1.6A, 250 V ac

RS Stock number 668-6076



### Dimensions: (mm)

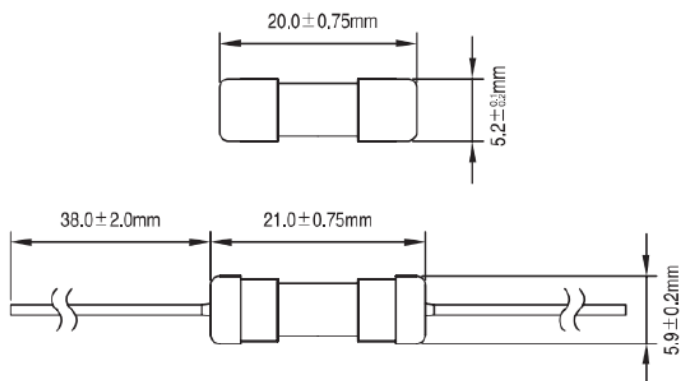

### Specifications

- Operating Temperature: -55°C to + 125°C
- Materials:
  - Glass Body / Nickel Plated Brass Caps
  - Lead Wire
  - Diameter 0.8mm 14A less
  - Diameter 1.0mm for rating above 15A to 19A
  - Diameter 1.2mm for rating above 20A

### Electrical Characteristics

Rated Current	1 In	1.35In	2 In
	MIN	MAX	MAX
10mA~20A	4 hr	1 hr	5 sec

### Interrupting Ratings

- 10mA~10A: 10,000 amperes at 125V AC
- 10mA~1A: 35 amperes at 250V AC
- 1.5A~3.5A: 100 amperes at 250V AC
- 3.75A~10A: 200 amperes at 250V AC

