

Mod. G7550 - Fittings Series 7000 - Automation

Product code: G7550 12

Datasheet creation date: 12/12/2025 08:33

Check the most updated document online [click here](#)



■ TECHNICAL DATA

Mod.	G7550 12
------	----------

Mod. G7550 - Fittings Series 7000 - Automation

Product code: G7550 12

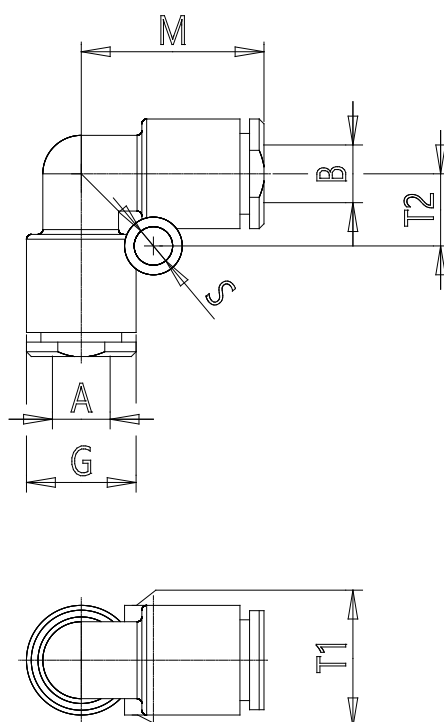

DIMENSIONS

A (mm)	12
B (mm)	12
GD (mm)	20.0
M (mm)	31.0
S (mm)	4
T1 (mm)	20.0
T2 (mm)	9.6
Weight (g)	15