



INSTALLATION AND MAINTENANCE INSTRUCTION FOR

DIRECT - ON - LINE STARTERS



IMPORTANT

This leaflet carries important information in respect of Health and Safety at Work and should remain with the starter at all times. Extra copies, if required, are available from the address shown.

GENERAL

Crompton Controls 'Series 3000' starters are manufactured to British standards BSEN60947-Pt4-Sec 1, BSEN60529-1992 and to IEC947-4-1. Crompton Controls manufacture the starters under a Quality Management System registered to ISO 9001:2008. All starters give degree of protection IP 55 (minimum) and are suitable for use up to an altitude of 2000 meters above sea level and for operation in ambient temperatures of -5°C to +40°C

SAFETY IMPORTANT

All electrical equipment for operating on low voltages contain devices which are capable of causing serious or fatal injuries.

Any person who is involved on installation or maintenance of this equipment should be fully competent to carry out this work. Such persons should be familiar with the Health and Safety at Work Act 1974 and the Electricity at Work Regulations 1989. Persons responsible for installation should also have a working knowledge of the IEE Wiring Regulations.

INSTALLATION

- 1 PREPARATION** The following points should be checked before commencing the installation of the starter.

- That the equipment is suitable for the voltage of the system.
- That the setting range of the overload unit is suitable for the motor involved.
- That the starter is suitable for the operating environment.
- General inspection of the starter should be carried out to make sure that there has been no damage caused by transportation or storage.

- 2 LOCATION AND MOUNTING** Modern high-performance contactors rely on the low inertia of their moving parts to achieve this performance. Because of this, any knocks or vibration can seriously affect the performance of these starters. It is essential, therefore, that the starter should be mounted away from any vibration and in a position where it is extremely unlikely that the starter will receive any knocks.

Although the starters are protected to IP55 thereby restricting the ingress of dust and moisture, the starter should be mounted in such a manner as to minimise the effects of dust and moisture. In particular, the effects of condensation occurring within the starter should be minimised.

It is essential, where dust and moisture are present, to take particular care when fixing the starter to the mounting surface and when making conduit connections to ensure that these areas are properly sealed.

When the mounting position has been decided, it may be advantageous to remove the starter interior from the enclosure to remove the knockouts, fasten the base to the mounting area and to complete the external wiring.

Where the only connection to the cover is an earth connection, this should be disconnected. Do not allow the cover to hang on the earth lead as this may affect earth continuity.

- 3 KNOCKOUTS** The starters are fitted with single knockouts and the methods of removal are shown below:-

KNOCKOUTS: WHEN REMOVING KNOCKOUTS CARE MUST BE TAKEN NOT TO DISTORT THE SIDE OF THE ENCLOSURE.

Single knockouts are designed to be removed INWARDS with a twisting/rocking action by applying a small chisel or similar tool to the extreme edge of the knockout at 90° to the retaining lugs and tapping with a hammer. Move tool across to the other edge and repeat process until knockout is released.

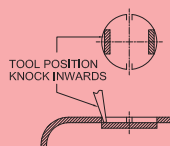

- 4 WIRING** All wiring connected to the starter should be in accordance with the latest edition of The Institute of Electrical Engineers Regulations for Electrical Installation.

It is essential that earthing of the starter is carried out in a proper manner. This is preferably done by the use of a separate earth conductor which also connects through to the motor. We do not recommend earthing via mounting points or conduit fittings, as these can become corroded and affect earth continuity.

- 5 CIRCUIT PROTECTION** The starter, cabling and the motor should be protected against short circuit conditions by adequately rated fuses or circuit breakers.

The overload unit fitted to the starter should be set to correspond to the full load current of the motor,

NOTE: - Some starters may be fitted with Thermistor Protection units used in conjunction with thermistors fitted in the motor to give over-temperature protection. The protection given in this case is dependent on the thermistors fitted to the motor and consequently adjustment of this unit is not required.

- 6 FINAL CHECKING AND TESTING** Before applying power to the starter, it is advisable to carry out the following checks:-

- Check all mechanical fixings to ensure that they are tight.
- Check all terminals to ensure that they are tight especially the earth connection.
- Check that the moving contact carriage of all contactors are free to operate.
- Set any timers which may be included in the starter to the approximate time required.
- Ensure that the earth connection between base and cover is in place.

In the interest of safety, we recommend that the cover of the starter is secured in place before applying power to the starter and that testing should only be carried out in this condition. Any adjustments which may be necessary should be carried out with the supply isolated.

WORKING ON LIVE EQUIPMENT

As a general rule, this equipment should be disconnected from the supply before carrying out work of any nature. However, there may be times, particularly during servicing when it is necessary to work on the equipment with the supply connected (e.g. checking voltages and currents).

Although these starters have been designed to afford finger protection, it is essential to observe the following precautions before working on the starters with the supply connected:-

- Ensure that it is absolutely necessary to work on the equipment whilst in a live condition.
- Ensure that you are fully aware of the layout of the starter and where to expect live connections.
- Ensure that you are within sight of other people who could come to your aid if necessary.
- Ensure that any tools equipment used are suitable for working on live equipment.

- 7 OPERATIONAL PROBLEMS** Should you have any doubts regarding operational problems, application of starters or any technical queries, our technical staff are available to advise. This advice is available via our field Sales Engineers or via our Head Office as shown on this leaflet.

- 8 FAULTY OPERATION** In the unlikely event of faulty operation, please check the complete system. If you are certain that the fault lies in the starter, contact your supplier who will negotiate any warranty claim with Crompton Controls. In the event of any difficulties, you may contact Crompton Controls direct at the address shown on this leaflet.

MAINTENANCE

- 1 GENERAL** Crompton controls 'Series 3000' starters are designed to give long trouble-free operation. The life of the starter will, of course, depend on the duty to which it is subjected. The operational (electrical) life at full current rating of the contactors is designed to be 500,000 operations.

However, as with any equipment, it is advisable to carry out routine checks to ensure that there are no problems developing which could cause failure.

- 2 CHECKING** Before carrying out routine checks, it is important to observe safety precautions printed in bold type under installation. The following checks are advisable:-
 - Check all screws, fixings and terminals to ensure that they are tight.
 - Check all moving parts for ease of operation.
 - Examine all wiring for damaged insulation.

- Check cover seals and conduit entries to ensure that sealing is still intact.
- Check all earth connections.
- Check visually for signs of overheating or arc damage. Any such damage should be investigated and remedied without delay.
- Check for ingress of dust and/or moisture which could adversely affect the equipment.

OVERLOAD RELAY FITTING INSTRUCTIONS

When fitting an overload relay into this starter the following procedure should be observed.

- Unscrew the Contactor male terminal screws until the clamps are fully open.
- Attach the start push button contact block to the overload as shown in the sketch below. When correctly located only a very light force is required to clip the block into position.
- Align the overload pins according to the contactor selection. Fit the overload pins into the contactor terminals and tighten the terminal screws, ensuring that all three pins are underneath the terminal clamps.

ASSEMBLY/REMOVAL OF START CONTACT

The start contact is clipped into position adjacent to terminal 96 on the overload relay.

ASSEMBLY:

Locate contact on lower right hand corner of overload relay moulding and rotate anti-clockwise until firmly clipped into place

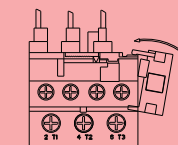

REMOVAL:

Place small screwdriver blade under leading edge of clip and lever off

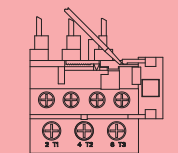

REMOVAL OF CONTACTORS FROM DIN FORM MOUNTING RAIL

Use narrow bladed screwdriver to move clip in direction of arrow 'A' as shown on drawing right, whilst lifting the unit from the mounting rail. This can be done with the overload unit fitted to the contactor if in doubt remove overload unit from contactor to improve access to the clip.

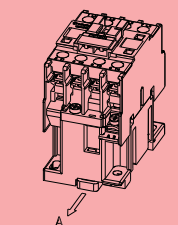

- 3 SPARES** Most parts of the starters are not regarded as serviceable items and therefore, in general, complete components are required. The following list gives a guide to the parts which are available and the information required when ordering replacement parts.

In order to ensure that the correct parts are supplied please quote the details given on the starter rating plate and the details given on the component rating plate along with the information shown alongside the description.

- Contactors – Voltage and frequency.
- Contactor coils – Voltage and frequency.
- Overload Units – Current range.
- Mechanical interlocks.
- Timers – Voltage, Frequency and Timing Range.
- Isolators.

CIRCUIT DIAGRAM TYPE 415V 3 Phase

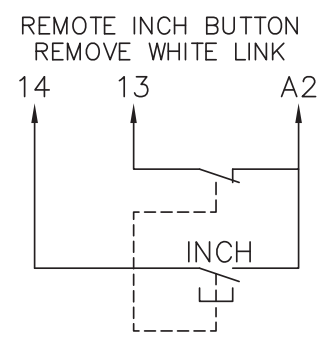
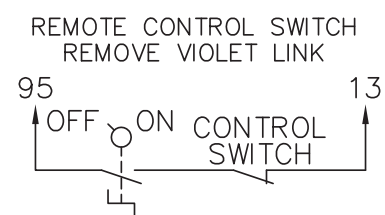
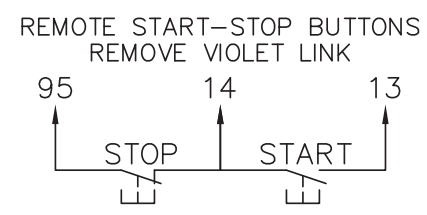
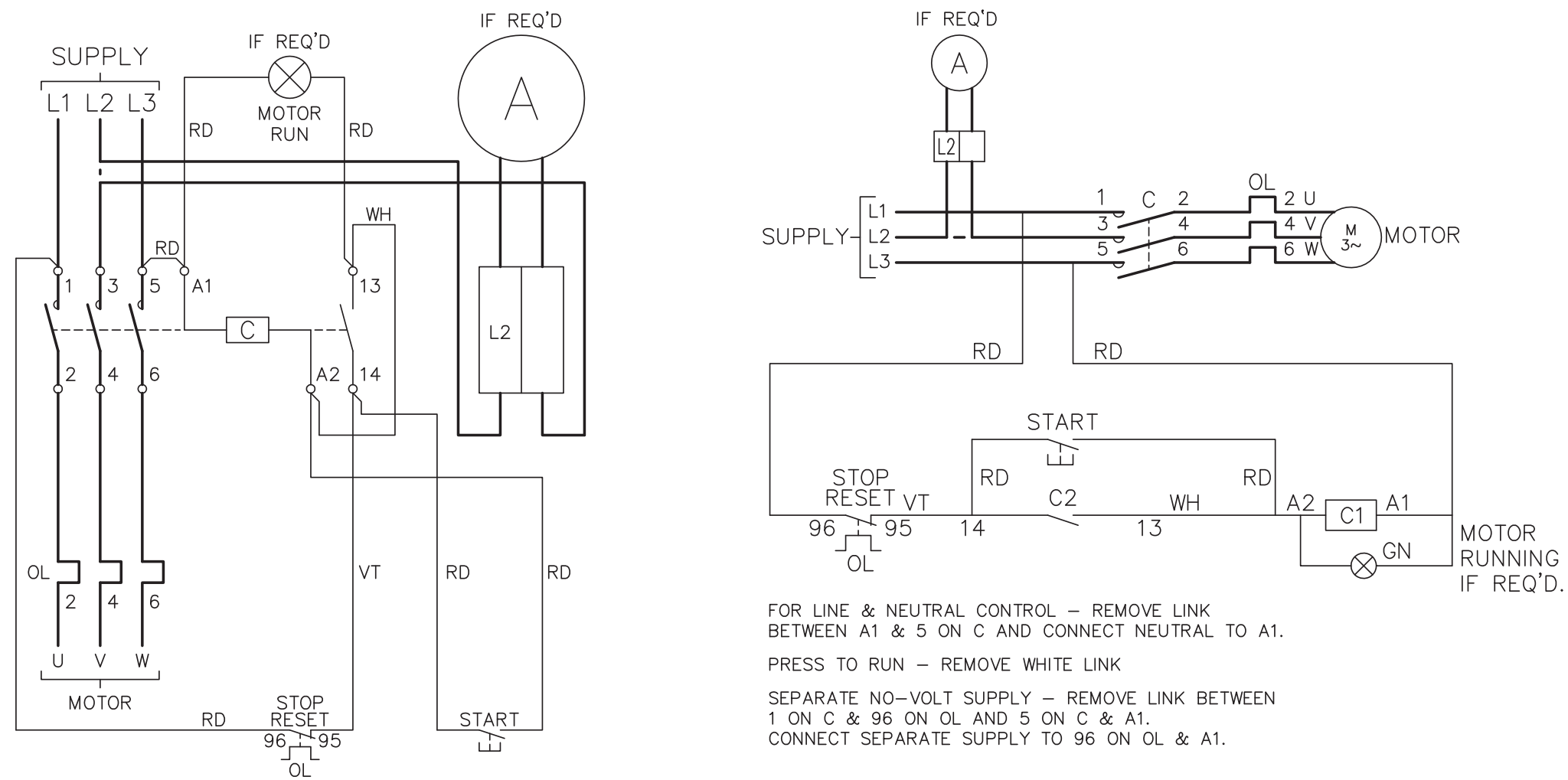

CIRCUIT DIAGRAM TYPE 240V 1 Phase

