

Datasheet

Zinc Plated Steel Dome Nut

RS Stock number: 293-088

Dimensions(mm):

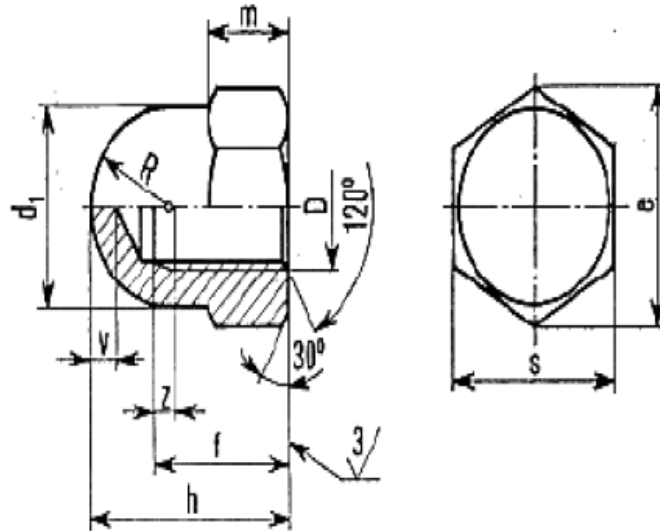

Filettatura D S H	d ₁	e min.	f J ₃ 15	h h 14	m J ₃ 14	R	S		v min.	Massa per 1000 pezzi ≈ kg
							nominale	tolleranza		
M 3	5	6,08	4	6,5	2,4	2,5	5,5	h 12	1	0,80
M 4	6,5	7,74	5	8,5	3,2	3,25	7		1	1,60
M 5	7,5	8,87	7	11	4	3,75	8		1	2,30
M 6	9,5	11,05	8	13	5	4,75	10	h 13	2	4,60
M 8	12,5	14,38	11	16	6,5	6,25	13		2	11
M 10	16	18,90	13	19	8	8	17		2	20,10
M 12	18	21,10	16	22	10	9	19		3	28,30
M 14	21	24,49	18	25	11	10,5	22		3	39,40
M 16	23	26,75	21	28	13	11,5	24		3	54,30
M 18	26	30,14	25	32	15	13	27		3	95
M 20	29	33,53	26	34	16	14,5	30	3	104	
M 22	31	35,72	29	39	18	15,5	32	3	129	
M 24	34	39,98	31	42	19	17	36	h 14	3	216