



## Datasheet

### RS PRO Sub-Miniature Pushbutton Switches

Stock number: **175-8617, 175-8611**

EN



The picture above is for reference only.  
Please refer to the table in the drawing below for other colors.

#### Package Contain:

- 1x Nut
- 1x Locking Washer
- 1x Splash Proof O-Ring

#### Specifications:

- Switch type: Pushbutton
- Poles/throws: SPST
- Switch functions: off-mom

#### Max. Current/voltage rating with resistive load:

400ma 32vac - 200 ma 50vdc - 125 ma 125vac.

**Initial contact resistance:** 50mΩmax.

**Insulation resistance:** 1GΩmin.at 500VDC.

**Dielectric strength:** 1,500 VAC rms.

**Electrical life at full load:** 500,000 cycles.

**Operating temperature:** -30°C to 85°C.

**Panel thickness:** 1.5 mm (.059) min. -4 mm (.157) max.

**Total travel:** 1.5 mm(.059)

**Operating force:** 3N~6N

**Contact bounce:** 10 ms.

**Mechanical life:** 1,000,000 cycles.

**Torque :** 0.5 Nm max. applied to nut

**Degree of protection:** IP68

**Manual soldering:**

Use soldering iron of 30 watts, controlled at 350°C approximately 5 seconds while applying solder.

**Wave soldering:**

Recommended soldering temperature: 260 ± 5°C

※Ambient temperature of the soldered surface of PCB.110°C max.

Duration of solder immersion: max 5 sec. (PCB is 1.6mm in thickness).

**RS Part no.**

175-8617 175-9625	SP Off-Mom. / High, Bright (Non LED) / Black Cap Color
175-8611 175-9534	SP Off-Mom. / High, Bright (Non LED) / Red Cap Color

# Specifications:

**1. Style :**

This specification describes “Snap-Acting Pushbutton Switches”, mainly used as signal switch of electric devices, with the general requirements of mechanical and electrical characteristic.

Operating Temperature Range : -30 °C~+85°C.

**2. Current Range :**

**2.1 Silver Plating Standard :**

Plating		Rating
C=Gold over silver	Fixed Terminal : Copper alloy with silver plated over gold plate. Movable contact : Copper alloy with silver plated over gold plate.	400mA @32VAC Max. 125mA @125VAC Max. 200mA @50VDC Max.

**3. Type of Actuation : Snap-Acting Pushbutton Switches.**

**4. Test Sequence :**

ELECTRIC PERFORMANCE	ITEM	DESCRIPTION	TEST CONDITIONS	REQUIREMENTS
	1	Visual Examination	By Visual Examination check without and out pressure & testing.	There shall be no defects that affect the serviceability of the product.
	2	Contact Resistance	To be measured between the two terminals associated with each switch pole.	50mΩ Max.
	3	Insulation Resistance	Measurements shall be made following application of 500 V/DC 100mA potential across terminals and cover for 1 minute.	1GΩ min/500V.
	4	Dielectric Withstanding Voltage	1500 VAC(50Hz or 60Hz) Between the two terminals contacts for 1 minute.	There shall be no breakdown or flashover.

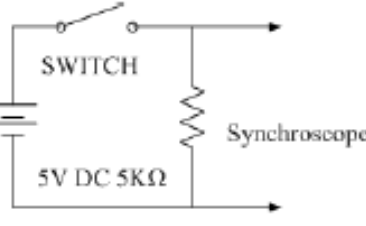
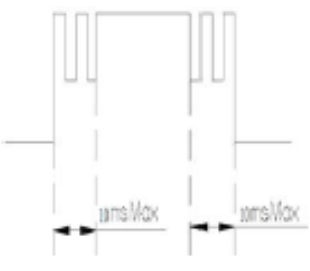
ELECTRIC PERFORMANCE	ITEM	DESCRIPTION	TEST CONDITIONS	REQUIREMENTS
	5	Bounce	<p>3 to 4 operations at a rate of 1 cycle per second.</p> 	<p>10 m seconds max.</p> 
MECHANICAL PERFORMANCE	6	Actuation Force	<p>MODEL-1305N MECHANICAL TEST 500gram、1000gram、2000gram. OFF TO ON Total Travel.</p>	<p>①At for test the force. Force : 3N~6N. ②Total Travel : 1.5mm ③Operating Position : 1.10mm±0.20mm</p>
	7	Torque	Applied to nut.	About 0.5 Nm Max.
OPERATING LIFE	8	Operating Life	<p>Measurements shall be made following the test forth below :</p> <p>①Plastic Material : 200mA,50VDC resistive load-gold over silver plated. ②Electronics Life Test : 500,000 cycles. ③Rate of Operation: 6-8 operation cycles per minute.</p> <hr/> <p>④Mechanical Life Test : 1,000,000cycles.</p>	<p>①Electronics Life Test : As shown in item 3~4. ②Mechanical Life Test : As shown in item 2~4.</p>

ITEM	DESCRIPTION	TEST CONDITIONS	REQUIREMENTS
9	Resistance Low Temperature	Following the test set forth below the sample shall be left in normal temperature and humidity conditions for 1 hour before the measurements are made : ①Temperature : $-30\pm 3^{\circ}\text{C}$ . ②Time : 96 hours.	As shown in item 2~4.
10	Resistance High Temperature	Following the test set forth below the sample shall be left in normal temperature and humidity conditions for an hour before the measurements are made : ①Temperature : $85\pm 3^{\circ}\text{C}$ . ②Time : 96 hours.	As shown in item 2~4.
11	Resistance Humidity	Following the test set forth below the sample shall be left in normal temperature and humidity conditions for an hour before the measurements are made : ①Temperature : $40\pm 2^{\circ}\text{C}$ . ②Relative Humidity : 90~95%. ③Time : 96 hours.	①Contact Resistance : 50mΩ Max. ②Insulation Resistance : 1GΩ min.
12	The Salt Testing	Following the test set forth below the sample shall be left in normal temperature and humidity conditions for an hour before the measurements are made : ①Temperature : $35\pm 2^{\circ}\text{C}$ . ②The ratio of salt-water : 5%. ③The spray amount of salt-water : 1~2 ml/h. ④Time : 48 hours.	The testing standard based on bubble, crack, and magnifying glass with gauge.

HUMIDITY RESISTANCE

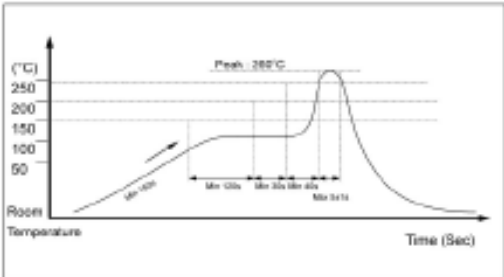
	ITEM	DESCRIPTION	TEST CONDITIONS	REQUIREMENTS
HUMIDITY RESISTANCE	13	HSF	Refer RoHS Standard : The electronic electrical machinery product limits with six big chemical materials.	Cd : 100ppm Pb : 1000ppm Hg : 1000ppm Cr6+ : 1000ppm PBB 、 PBDE : 1000ppm
	14	Test of IP 68	Protected against the effects of continuous immersion in water at a depth 1 m /60 minutes.	IP68 According to EN 60529 : 1991 + A1 : 2000 IEC 60529 : 2001
SOLDER HEAT RESISTANCE	15	Wave Soldering	<p>■ Wave Soldering :</p> <p>①Soldering Temperature:<math>260\pm 5^{\circ}\text{C}</math> .</p> <p>②Duration of Solder Immersion: <math>5\pm 1</math> seconds.</p> <p>Temperature Profile</p>  <p>③PCB is 1.6mm in thickness.</p> <p>■ Ambient temperature of the soldered Surface of PC board. <math>110^{\circ}\text{C}</math> Max.</p>	<p>①Shall be free from pronounced backlash and falling-off or breakage terminals.</p> <p>②As shown in item 2-4.</p>

SOLDER HEAT RESISTANCE	ITEM	DESCRIPTION	TEST CONDITIONS	REQUIREMENTS
	16	Manual Soldering	<p>■ Manual Soldering :</p> <p>① Soldering Temperature : 350°C Max.</p> <p>② Duration of Solder Heated : 5 seconds Max.</p> <p>■ Precautions in Handling</p> <p>① Care should be exercised so that flux from the upper part of the printed circuit board does not adhere to the switch.</p> <p>② Except for washable type do not wash the switch.</p> <p>③ Please make sure that there is no flux rose over the surface of the PCB.</p>	<p>① Shall be free from pronounced backlash and falling-off or breakage terminals.</p> <p>② As shown in item 2~4.</p>

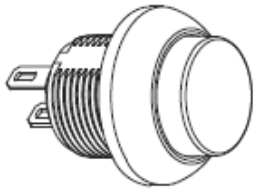
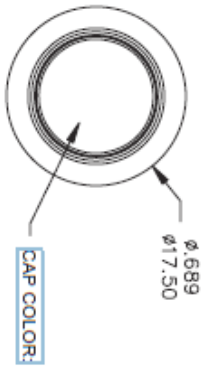

**MATERIALS**

- CAP: Polyamide 6/6.
- PLUNGER: PC.
- RUBBER: Silicone.
- BUSHING: Polyamide 6/6.
- CASE: Diallyl phthalate (DAP)(UL94v-0).
- TERMINAL/CONTACTS: Gold over silver plated.
- RoHS & Lead Free

PART NO.	PART NAME	QTY
1	MNU- PA03	1
2	MNU-1M08	1
3	FCP-A253	1

FILE NAME:HARDWARE-0085

Model No.	POS.1	POS.2
PFS6	OFF	MOM(ON)
CONNECTED TERMINALS	OPEN	CLOSE
SCHEMATIC		

**SWITCH FUNCTION**

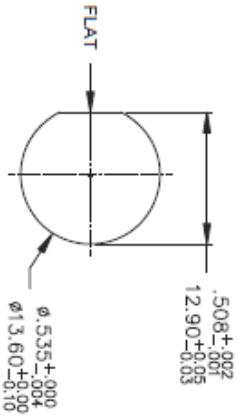
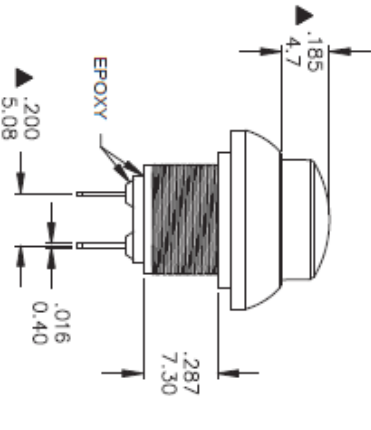
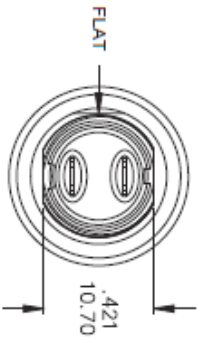
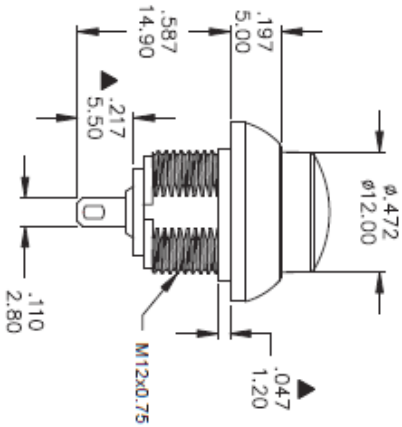

**PANEL CUT-OUT**

THICKNESS: 1.5 mm ~ 4.0 mm

**SPECIFICATIONS**

- Max. current/voltage rating with resistive load: 400mA 32VAC - 200 mA 50VDC - 125 mA 125VAC.
- INITIAL CONTACT RESISTANCE: 50 mΩ max.
- INSULATION RESISTANCE: 1 GΩ min. at 500VDC.
- DIELECTRIC STRENGTH: 1,500 VAC rms.
- ELECTRICAL LIFE AT FULL LOAD: 500,000 cycles.
- TOTAL TRAVEL: 1.5 mm(.059).
- OPERATING FORCE: 3N~6N.
- CONTACT BOUNCE: 10 ms.
- MECHANICAL LIFE: 1,000,000 cycles.
- TORQUE: 0.5 Nm max. applied to nut.
- SOLDERING: 350°C max. for 5 seconds.
- OPERATING TEMPERATURE: -30°C to 85°C.
- DEGREE OF PROTECTION: IP68