

Connecting cables, Ethernet

Technical data

Connecting cable NEBC-D12G4

- Connecting cable M12 4-pin
- D-coded
- Cable lengths 0.5 ... 10 m
- Suitable for Ethernet



General technical data					
Cable characteristic	Suitable for use with energy chains			Basic	
Electrical connection	Straight plug connector, 4-pin, M12x1, D-coded	Straight plug connector, RJ45, 8-pin	Open cable end, 4-wire	Straight plug connector, 4-pin, M12x1, D-coded	Straight plug connector, RJ45, 8-pin
Conforms to standard	EN 61076-2-101	IEC 60603-7-3	–	–	–
Ethernet cable specification	Type: CAT5			Type: CAT5	
Transmission characteristics	In accordance with category 5, EN 50173, class D			–	
	In accordance with category 5, ISO/IEC 11801, class D			–	
Operating voltage range	[V DC]	0 ... 30	0 ... 30	0 ... 30	0 ... 50
	[V AC]	–	–	0 ... 30	–
Surge resistance	[kV]	0.8	0.8	0.8	0.8
Acceptable current load at 40 °C	[A]	4	1.76	4	1
Cable composition	4 x 0.34 mm ²			4 x 0.14 mm ²	
Cable diameter	[mm]	6.7		6.4 ±0.2 mm	
Nominal conductor cross section	[mm ²]	0.34		0.34	
Min. bending radius	[mm]	100		100	
Wire ends	–	–	Cut off bluntly, sheath removed	–	–
Cable characteristic	Suitable for use with energy chains			Basic	
Cable test conditions	Bending strength: according to Festo standard			Bending strength: according to Festo standard	
	Test conditions on request			–	
	Energy chain: 2 million cycles, bending radius 100 mm			–	
Nominal tightening torque	[Nm]	0.5	–	–	–
Degree of protection to EN 60529	IP65, IP67	IP20	–	IP67	IP20

Materials					
Cable characteristic	Suitable for use with energy chains			Basic	
	Plug connector M12x1	RJ45 plug connector	Open cable end	Plug connector M12x1	RJ45 plug connector
Housing	TPE-U (PUR)	PA	PA	–	–
	–	Nickel-plated brass	Nickel-plated brass	–	–
Housing colour	Black	Black	Black	–	–
Threaded sleeve	Die-cast zinc	–	–	–	–
Pin contact	Gold-plated brass			Nickel-plated and gold-plated brass	
Cable sheath	TPE-U (PUR) ¹⁾			TPE-U (PUR)	
Cable sheath colour	Green			Blue	
Insulating sheath	PE			–	
Note on materials	RoHS compliant			RoHS compliant	
	Free of copper and PTFE			–	
Special characteristics	Oil-resistant			–	

1) The cable sheath contains esters of phosphoric acid. Under unfavourable conditions, tubing made from TPE-U (PU), such as PUN tubing, can be damaged in the event of common installation.

Connecting cables, Ethernet

Technical data

Operating and environmental conditions					
Cable characteristic	Suitable for use with energy chains			Basic	
	Plug connector M12x1	RJ45 plug connector	Open cable end	Plug connector M12x1	RJ45 plug connector
Ambient temperature [°C]	-25 ... +80			-	
Ambient temperature with flexible cable installation [°C]	-20 ... +60			-20 ... +80	
Degree of contamination	3			-	
Certification certificate	-	-	c UL us listed (OL)	-	

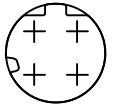
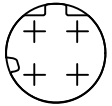
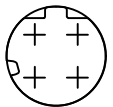
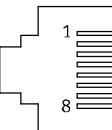
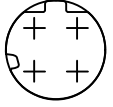
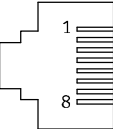
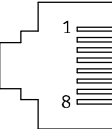
Wiring allocation (plug view)					
	Pin	Wire colour ¹⁾		Pin	
Electrical connection, plug connector, M12x1, 4-pin – plug connector, M12x1, 4-pin					
	1	YE		1	
	2	WH		2	
	3	OG		3	
	4	BU		4	
Electrical connection, plug connector, M12x1, 4-pin – plug connector, RJ45, 8-pin					
	1	YE		1	
	2	WH		3	
	3	OG		2	
	4	BU		6	
	-	-		4	
	-	-		5	
	-	-		7	
	-	-		8	
Electrical connection, plug connector, M12x1, 4-pin – open cable end					
	1	YE		-	-
	2	WH		-	
	3	OG		-	
	4	BU		-	
Electrical connection, plug connector, RJ45, 8-pin – plug connector, RJ45, 8-pin					
	1	YE		1	
	2	OG		2	
	3	WH		3	
	4	-		4	
	5	-		5	
	6	BU		6	
	7	-		7	
	8	-		8	

1) To IEC 757

Connecting cables, Ethernet

Technical data

Dimensions

Download CAD data → www.festo.com

Connection technology, left-hand end

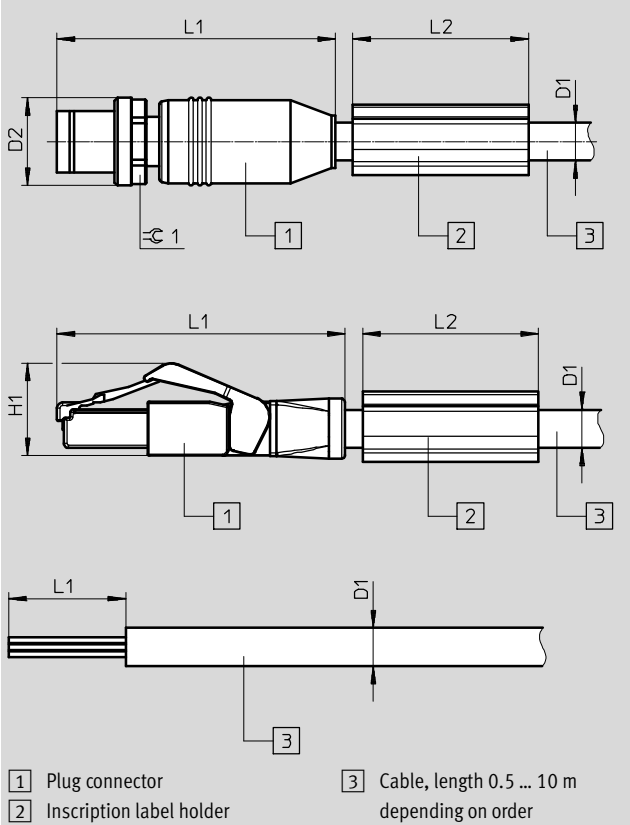

Connection technology, right-hand end

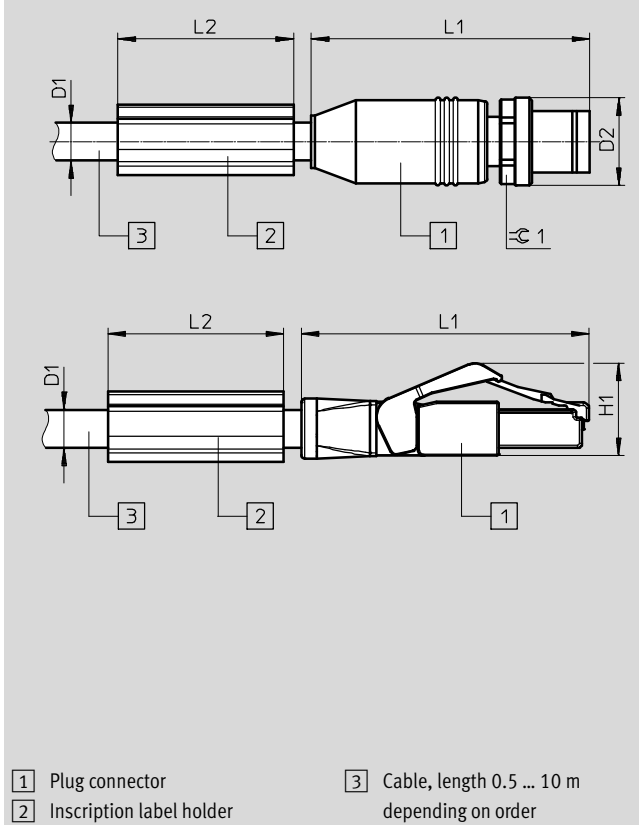

Connection technology, left-hand end	D1 Ø	D2 Ø	L1	L2	H1	≙1
Cable characteristics: Suitable for use with energy chains						
Plug connector M12x1	6.7	15	47.5	30	-	13
RJ45 plug connector	6.7	-	49	30	15.8	-
Open end	6.7	-	20	-	-	-
Cable property: Basic						
Plug connector M12x1	6.4	14.8	47.3	-	-	-

Connection technology, right-hand end	D1 Ø	D2 Ø	L1	L2	H1	≙1
Cable characteristics: Suitable for use with energy chains						
Plug connector M12x1	6.7	15	47.5	30	-	13
RJ45 plug connector	6.7	-	49	30	15.8	-
Cable property: Basic						
RJ45 plug connector	6.4	-	44.7	-	15.8	-

Connecting cables, Ethernet

Technical data

Ordering data					
Electrical connection 1	Electrical connection 2	Weight [g]	Cable length [m]	Part No.	Type
Cable characteristics: Suitable for use with energy chains					
Straight plug connector, M12x1, 4-pin, D-coded	Straight plug connector, M12x1, 4-pin, D-coded	57	0.5	8040446	NEBC-D12G4-ES-0.5-S-D12G4-ET
		93	1	8040447	NEBC-D12G4-ES-1-S-D12G4-ET
		223	3	8040448	NEBC-D12G4-ES-3-S-D12G4-ET
		350	5	8040449	NEBC-D12G4-ES-5-S-D12G4-ET
		679	10	8040450	NEBC-D12G4-ES-10-S-D12G4-ET
	Straight plug connector, RJ45, 8-pin	89	1	8040451	NEBC-D12G4-ES-1-S-R3G4-ET
		219	3	8040452	NEBC-D12G4-ES-3-S-R3G4-ET
		347	5	8040453	NEBC-D12G4-ES-5-S-R3G4-ET
		674	10	8040454	NEBC-D12G4-ES-10-S-R3G4-ET
	Open end, 4-wire	341	5	8040456	NEBC-LE4-ES-5-D12G4-ET
Straight plug connector, RJ45, 8-pin	Straight plug connector, RJ45, 8-pin	87	1	8040455	NEBC-R3G4-ES-1-S-R3G4-ET
Cable property: Basic					
Straight plug connector, M12x1, 4-pin, D-coded	Straight plug connector, RJ45, 8-pin	157	3	8031121	NEBC-D12G4-KS-3-R3G4
		455	10	8031122	NEBC-D12G4-KS-10-R3G4

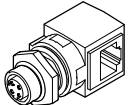
Ordering data – Accessories					
	Electrical connection 1	Electrical connection 2	Part No.	Type	
Control cabinet through-hole					
	Straight socket, 4-pin, M12x1, D-coded	Straight socket, 4-pin, M12x1, D-coded	8040459	NEFU-D12G4-D12DG4	
		Angled socket, 8-pin, RJ45	8040457	NEFU-D12G4-R3DW4	