

# Photoelectrics Retro-reflective, Polarized Type PH18CNP..., DC

CARLO GAVAZZI



- Miniature sensor range
- Range: 5 m
- Sensitivity adjustment by potentiometer
- Modulated, red light 625 nm
- Supply voltage: 10 to 30 VDC
- Output: 100 mA, NPN or PNP, N.O & N.C.
- Degree of protection: IP67, IP69K
- LED indication for output, stability and power ON
- Protection: reverse polarity, short circuit and transients
- Cable, plug and pigtail versions
- Excellent EMC performance



## Product Description

The PH18CNP... is part of a family of inexpensive general purpose retro-reflective sensors in industrial standard 18 mm cylindrical and square ABS housing. The sensors are useful in applications where high-accuracy detection as well as small size is required.

Compact housing and high power LED for excellent performance-size ratio. The potentiometer used for adjustment of the sensitivity makes the sensors highly flexible. The output type is NPN or PNP and the output switching function is NO and NC.

## Ordering Key

PH18CNP50PAM1SA

Type	_____
Housing style square	_____
Housing size	_____
Housing material	_____
Housing type neutral	_____
Detection principle	_____
Sensing distance	_____
Output type	_____
Output configuration	_____
Connection type	_____
Sensitive adjustment	_____

## Type Selection

Housing style	Range S <sub>n</sub>	Connection	Ordering no. NPN Make & break switching	Ordering no. PNP Make & break switching
M18 Square type	5.0 m	Cable	PH 18 CNP 50 NASA	PH 18 CNP 50 PASA
M18 Square type	5.0 m	Plug	PH 18 CNP 50 NAM1SA	PH 18 CNP 50 PAM1SA
M18 Square type	5.0 m	Pigtail M12	PH 18 CNP 50 NAT1SA	PH 18 CNP 50 PAT1SA

## Specifications according to EN60947-5-2

<b>Rated operating distance (S<sub>n</sub>)</b>	Up to 5.0 m, Reference target: ER4 reflector ø 80 mm	<b>Voltage drop (U<sub>d</sub>)</b>	≤ 2.0 VDC @ 100 mA
<b>Blind zone</b>	100 mm	<b>Protection</b>	Short-circuit, reverse polarity and transients
<b>Sensitivity control</b>	Adjustable by potentiometer 270°	<b>Light source</b>	InGaAlP, LED, 625 nm
Adjustable distance to target	50-500 cm	<b>Light type</b>	Red, modulated
<b>Temperature drift</b>	≤ 0.2%/°C	<b>Sensing angle</b>	± 2°
<b>Hysteresis (H) (differential travel)</b>	≤ 20%	<b>Ambient light</b>	30.000 lux Incandescent lamp
<b>Rated operational volt. (U<sub>B</sub>)</b>	10 to 30 VDC (ripple included)	<b>Light spot Diameter</b>	Ø 150 mm @ 2.5 m
<b>Ripple (U<sub>rpp</sub>)</b>	≤ 10%	<b>Operating frequency</b>	500 Hz
<b>Output current</b> Continuous (I <sub>a</sub> ) Short-time (I)	≤ 100 mA ≤ 100 mA (max. load capacity 100 nF)	<b>Response time</b> OFF-ON (t <sub>ON</sub> ) ON-OFF (t <sub>OFF</sub> )	≤ 1.0 ms ≤ 1.0 ms
<b>No load supply current (I<sub>o</sub>)</b>	≤ 20 mA @ 24 VDC	<b>Power ON delay (t<sub>v</sub>)</b>	≤ 300 ms
<b>Minimum operational current (I<sub>m</sub>)</b>	0.5 mA	<b>Output function</b> Type Switching function	NPN or PNP NO and NC
<b>OFF-state current (I<sub>r</sub>)</b>	≤ 100 µA	<b>Indication</b> Output ON Signal stability and power ON	LED, yellow LED, green



## Specifications (cont.)

<b>Environment</b>		<b>Connection</b>	
Installation category	III (IEC 60664/60664A; 60947-1)	Cable	PVC, grey, 2 m 4 x 0.25 mm <sup>2</sup> , Ø = 4.5 mm
Pollution degree	3 (IEC 60664/60664A; 60947-1)	Plug	M12, 4-pin (CONM14NF-series)
Degree of protection	IP 67, IP 69K*	Pigtail	PUR, grey, 30 cm 4 x 0.25 mm <sup>2</sup> , Ø = 4.5 mm M12, 4-pin (CONM14NF-series)
<b>Ambient temperature</b>		<b>Weight</b>	
Operating	-25° to +60°C (-13° to +140°F)	With cable: 75 g	
Storage	-40° to +70°C (-40° to +158°F)	With plug: 10 g	
<b>Vibration</b>	10 to 55 Hz, 0.5 mm/7.5 g (IEC 60068-2-6)	With pigtail: 35 g	
<b>Shock</b>	30 g / 11ms, 3 pos, 3 neg per axis (IEC 60068-2-6, 60068-2-32)	<b>CE-marking</b>	Yes
<b>Rated insulation voltage</b>	500 VAC (rms) IEC protection class III	<b>Approvals</b>	cULus (UL508) supply class 2
<b>Housing material</b>			
Body	ABS, grey		
Front material	PMMA, red		

\* The IP69K test according to DIN 40050-9 for high-pressure, high-temperature wash-down applications. The sensor must not only be dust tight (IP6X), but also able to withstand high-pressure and steam cleaning. The sensor is exposed to high pressure water from a spray nozzle that is fed with 80°C water at 8'000– 10'000 KPa (80–100bar) and a flow rate of 14–6L/min. The nozzle is held 100 –150 mm from the sensor at angles of 0°, 30°, 60° and 90° for 30s each. The test device sits on a turntable that rotates with a speed of 5 times per minute. The sensor must not suffer any damaging effects from the high pressure water in appearance and function.

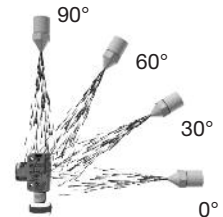

## Operation Diagram

tv = Power ON delay

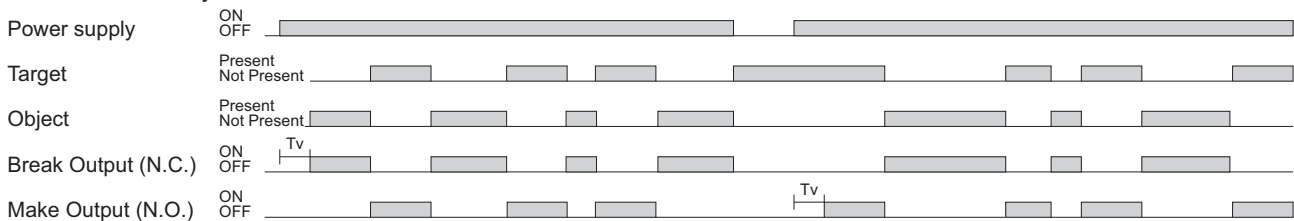

## Wiring Diagrams

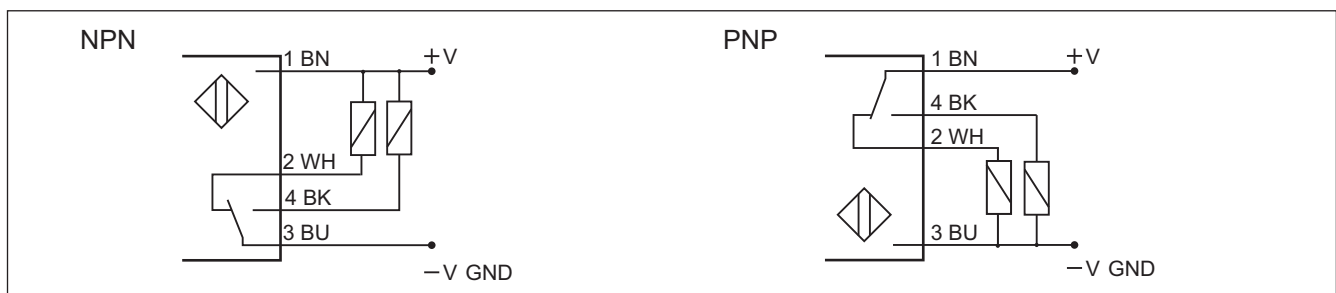

### Detection Diagram

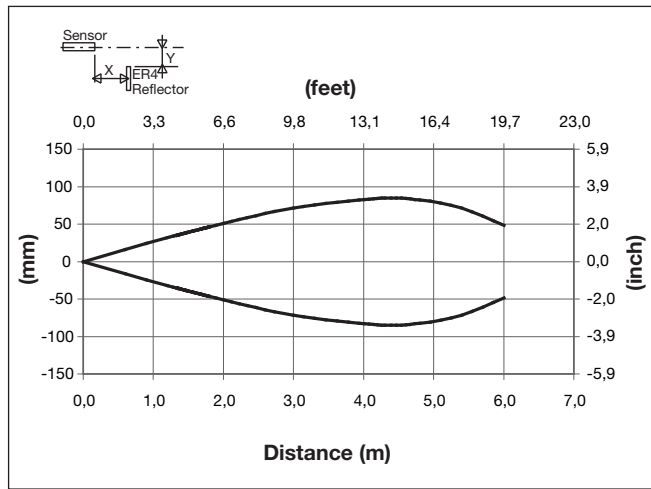

### Excess Gain

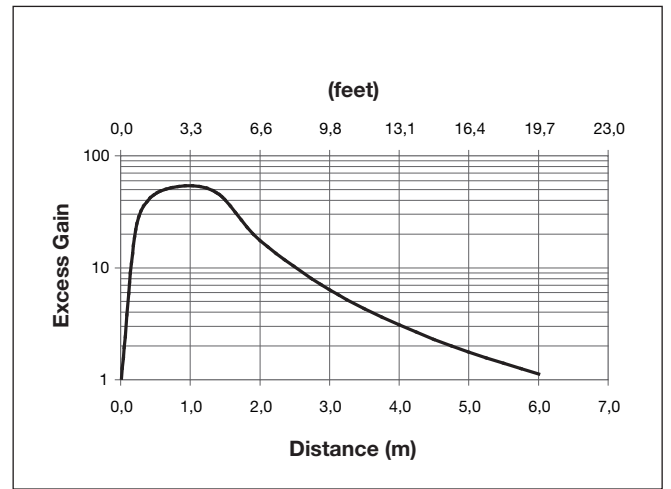

### Signal Stability Indication

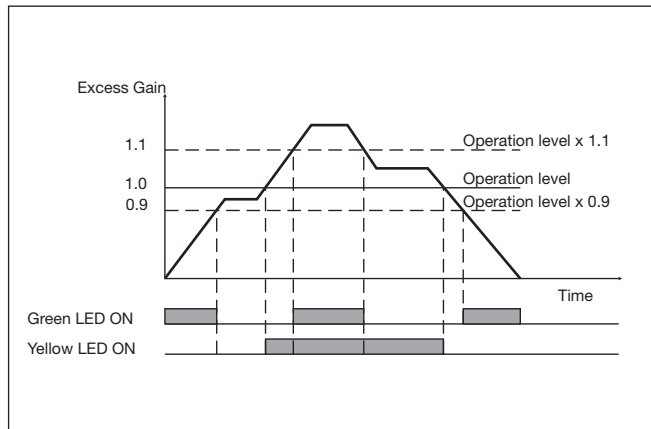

### APH18-MB1

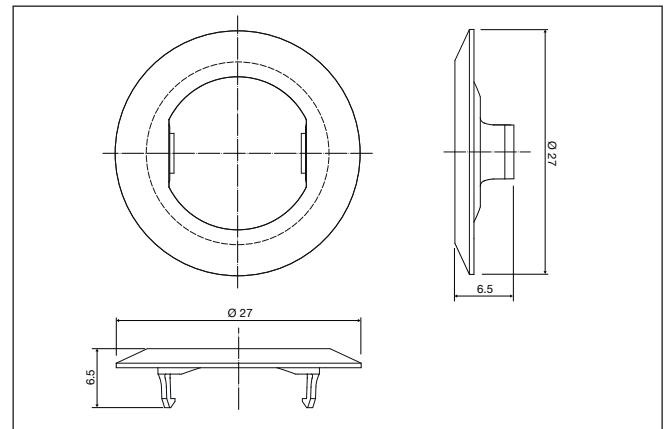

### Mounting Systems



PH18 mounting with a combination of 1 x APH18-MB1 and 1 x M18 locknut. Maximum torque 0.9 NM

## Dimensions

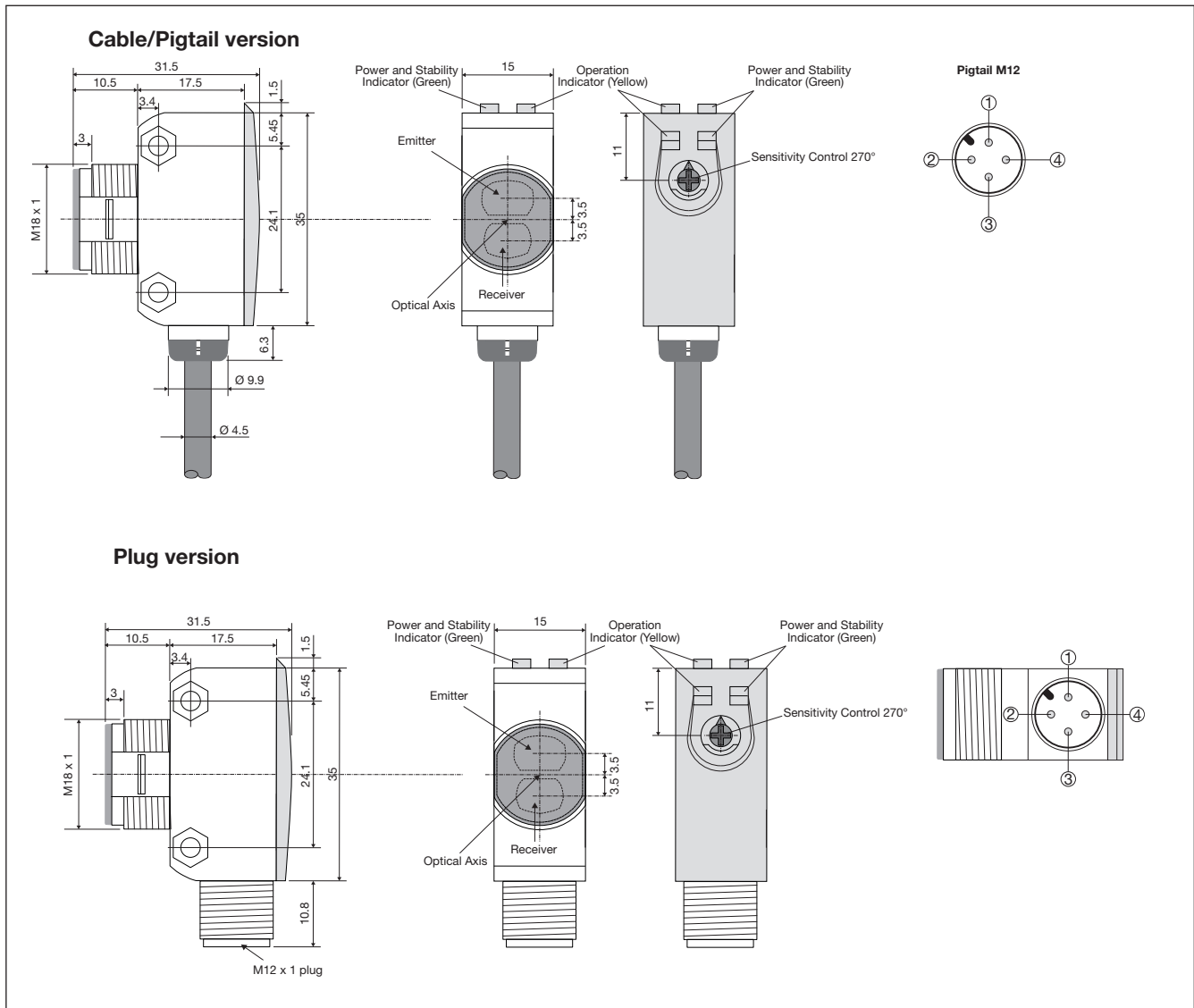

## Installation Hints

<p>To avoid interference from inductive voltage / current peaks, separate the proximity switch cables from any other power cables. E.g. Engine, contactor or solenoid cables</p>	<p>Relief of the cable strain</p> <p>The cable should not be pulled</p>	<p>Protection of the sensing face</p> <p>A proximity switch should not serve as mechanical stop</p>	<p>Sensor mounted on a mobile carrier</p> <p>Any repetitive flexing of the cable should be avoided</p>
--	---	---	--

## **Delivery Contents**

---

- Photoelectric switch: PH 18 CNP...
- Installation instruction on plastic bag
- Screwdriver
- Mounting bracket APH18-MB1
- 1 M18 lock nuts
- **Packaging:** Plastic bag

## **Accessories**

---

- Connector type CONG1A.. / CONM14NF.. series
- Reflector type ER.. - to be purchased separately