

Mobrey

MSP422 Analogue Liquid Level Transmitter

Installation, operation & maintenance instructions
IP2013

MSP422 Programming Menu IP2013/PM

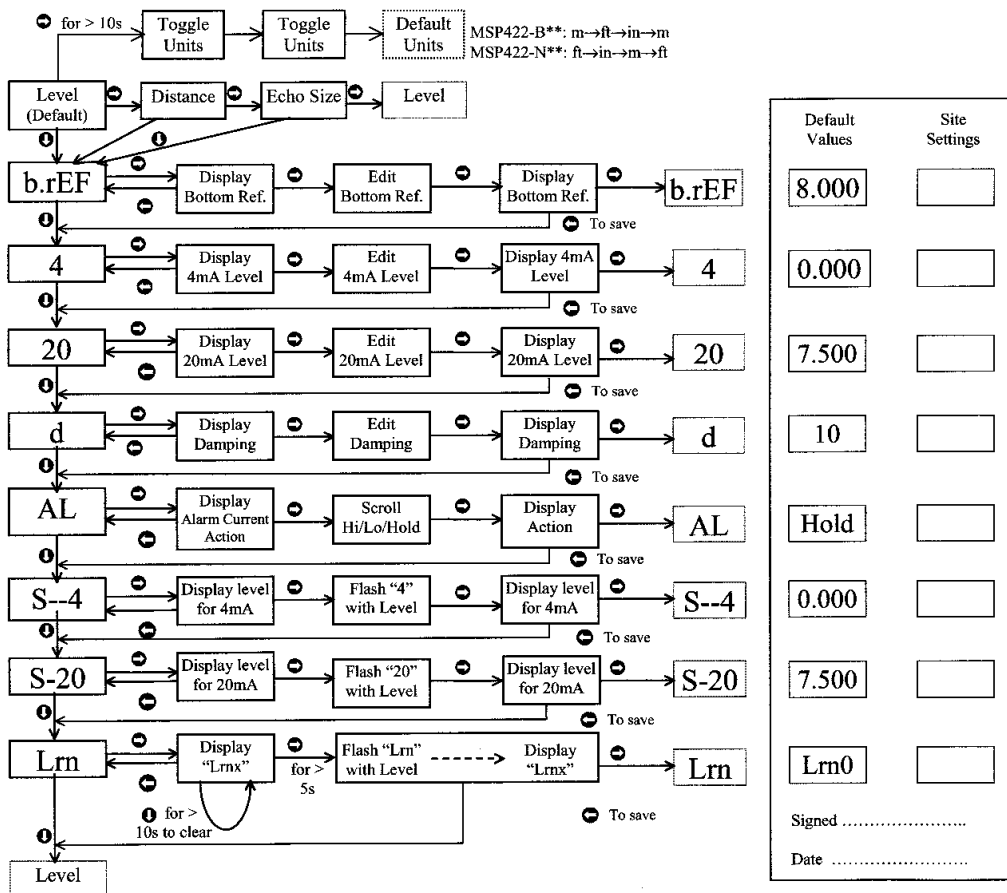

IMPORTANT SAFETY NOTICE

The MSP422 is designed for safe area use only, and must not be installed in a hazardous area, even if the power is supplied through a barrier device.



HANDLE WITH CARE

The MSP422 is a measuring instrument and should be handled with due care and attention at all times.

	INDEX	PAGE
1.0	Specification	3
2.0	Installation	4
3.0	Wiring	5
4.0	Commissioning & Operation	6
4.1	Power up	6
4.2	Calibration	6
4.2.1.	Display units	6
4.2.2.	First measurements	7
4.2.3.	Setting the correct bottom reference (b.rEF)	8
4.2.4.	Setting the 4 and 20mA levels	8
4.2.5.	Setting the damping applied to the output (d)	9
4.2.6.	Selecting the output current action on alarm condition	10
4.2.7.	Setting the 4 and 20mA levels using actual liquid levels in tank	11
4.2.8.	Blocking unwanted echoes from false targets	11
4.2.9.	Changing operation to distance mode	12
4.3	Power failure	12
4.4.	Final checks	12
5.0.	Fault Finding & Error Messages	13
5.1.	No display	13
5.2	No level reading	13
5.3	Error messages	13
6.0.	Maintenance	14
7.0.	Parameter default values	14
8.0.	Programming menu	15

1.0 SPECIFICATION

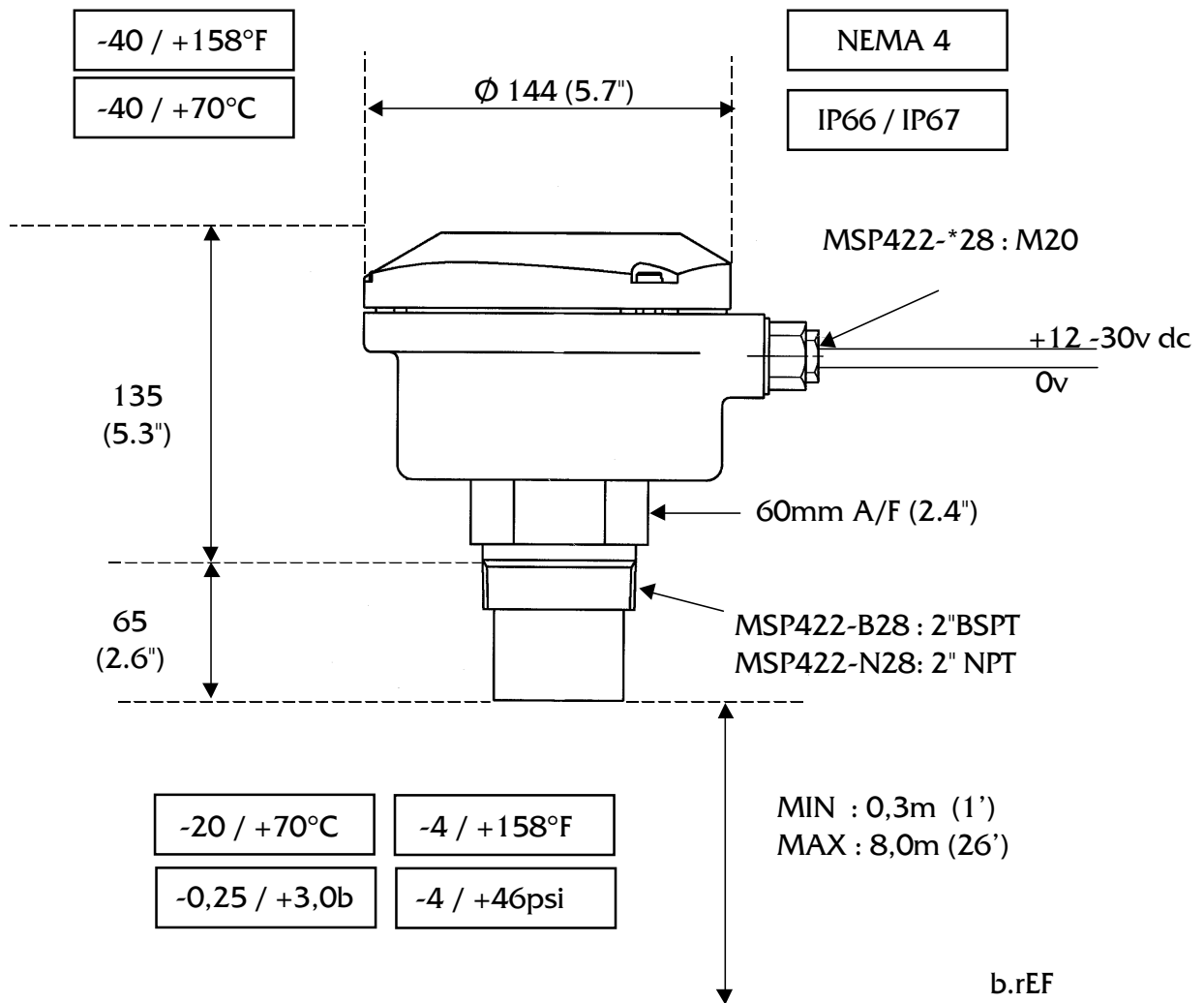

Housing & Cover Material	:	Glass filled Nylon
Wetside Material	:	P.V.D.F.
Electrical output	:	4-20mA (3.8 - 20.5mA linear)

2.0 INSTALLATION

The MSP422 is designed for safe area use only and must not be installed in a hazardous area, even if the power supply is via current limiting devices / barriers. If you have a requirement for a hazardous area installation, contact Solartron Mobrey for details of other instruments in the MSP range.

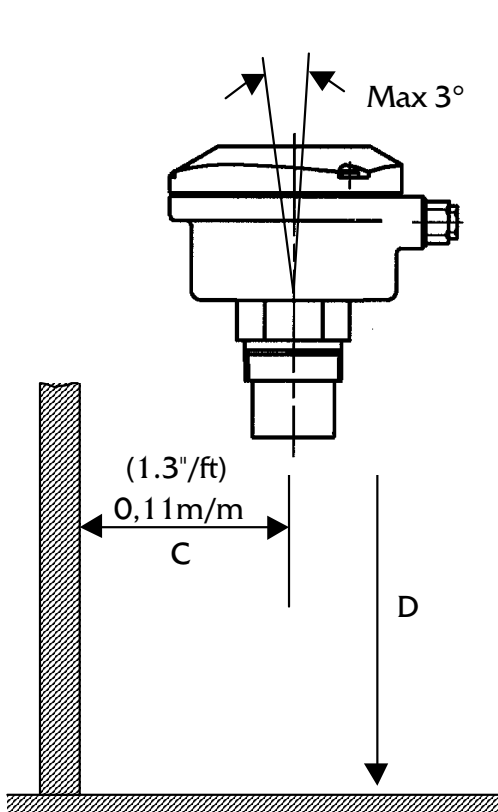

- i.e.
- D Min = 0,3m (1ft)
 - D Max = 8m (26ft)
 - C Min = 0,88m (3ft)

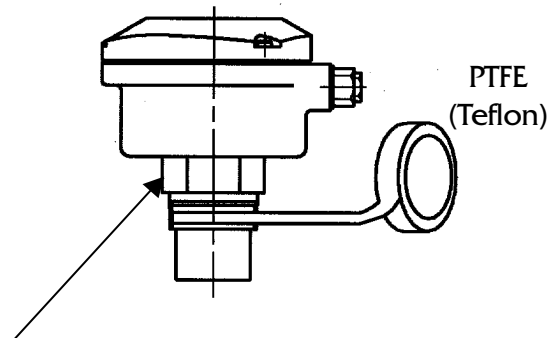
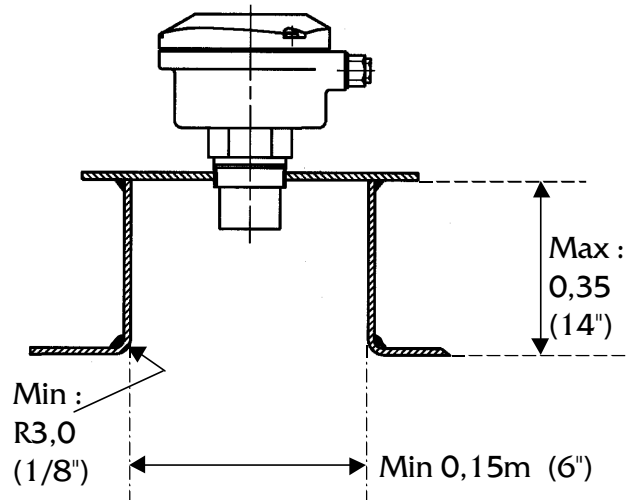

Use hexagon to tighten to 5kgm (3ft lb) max.
DO NOT USE HOUSING TO TIGHTEN.

To help installation, a bracket kit is available from Solartron Mobrey. This comprises a Stainless Steel angle bracket and PVC threaded disc which may be used to mount the MSP422 on a gantry or other support over the liquid level.

Order part number MSP-BRK2 (BSP) or MSP-BRK3 (NPT).

- Applications where there is heavy condensation likely on the instrument face should be avoided.
- Foaming liquids can reduce the size of the return echo. If possible, locate the transducer over an area of clear liquid, such as may be found around the liquid inlet point.
- If the MSP422 is in use in environments where direct sunlight can cause very high surface temperatures on exposed instruments, it is recommended that the installer should construct a suitable sun-shade to protect against this.

3.0 WIRING

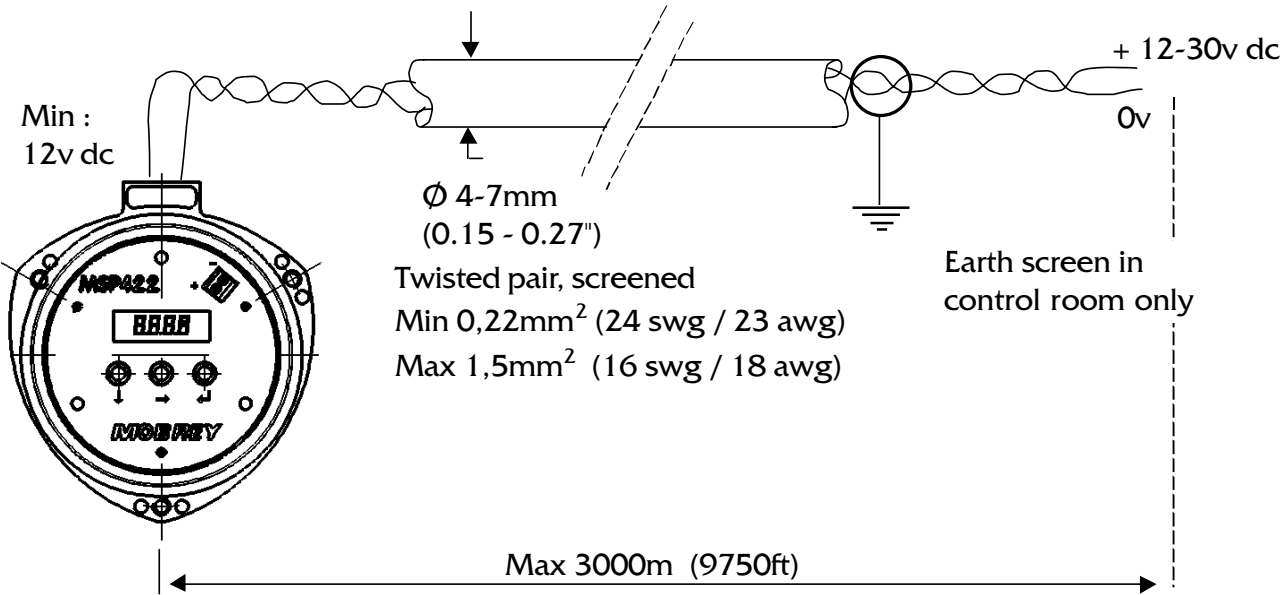

Multicore cable may be used, but it is recommended that each pair used to connect to an MSP422 should be individually shielded.

4.0 COMMISSIONING AND OPERATION

Refer to Programming card inside MSP422 or menu in this manual.

MSP422 operates from a menu of parameters held in memory. The instrument leaves the factory pre-programmed with a value in each parameter location such that, when power is first applied, the instrument will give a sensible reading. A list of default values is given in the menu layout.

4.1 Power up

On power up, the MSP422 will take a few seconds to initialise, then the display will run through a set-up routine, showing a full set of figure eight's, then the software revision and finally a full set of zeros whilst the microprocessor identifies the correct return echo and confirms this repeats enough to be acceptable. The instrument is now ready for use, and is set-up using the 3 coloured push buttons.



Refer now to the Programme menu which is shown on the front of this manual and also in the instrument itself on a card tucked between the electronics housing and the body.

4.2 Calibration

4.2.1 Display units

Default values are as follows :-



MSP422-B28	Metres
MSP422-N28	Feet

The display units can be changed using the blue button . Simply hold the blue button  down for 10 seconds and the units will change to the next option in the following sequence :

Metres to Feet to Inches and back to Metres again.

This is indicated by the position of the decimal point in the displayed value :

Units	Display
m	8.000
ft.	26.24
in.	314.9

Once the units have changed from default to the next option, the blue button  can be released, in which case the new units selected are confirmed, or the blue button  can continue to be held down, in which case the next units option is given after a further three seconds.

When the display units have been programmed, please note that you must use the same units when programming in the bottom reference, 4 and 20mA points.

The 4-20mA output may be set to operate over all or just a part of the total measuring range. There is no theoretical limit on the minimum span of the current output, although in practice a span below 100mm is not recommended. With small spans, be aware that a high value of damping will greatly affect the performance of MSP422.

The 4mA level may be set above or below the 20mA level to suit the monitoring or control equipment.

Footnote : The MSP422 measures and calculates at all times in metres. The units of display are derived as a last operation using a pre-programmed conversion factor.

4.2.2 First measurements. With the MSP422 installed and display units selected, the display will now be showing what the instrument thinks is the liquid level. This is a value calculated by the microprocessor, being the difference between the distance to target being measured and the default value for the datum or bottom reference (b.rEF).

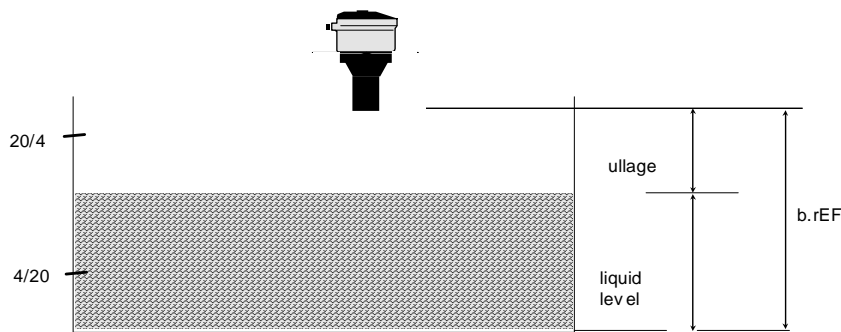

Before changing any of the default values, use blue button  to scroll along to the next piece of information, which is the distance to target as measured by the MSP422 from the front (transmit) face.

This value is shown alternately with the text “diSt” to remind the user the MSP422 display is in distance mode. You can now quickly check correct operation against a manual measurement if required.

TIP : A feature of the MSP422 useful at this stage is that it can be used as an electronic tape measure. With an empty tank or vessel, the MSP422 will read the distance to the bottom of the tank. This can be noted and used when setting b.rEF later.





Press blue button  again to scroll the display to show the echo size on a scale of 0-100. (It is possible to record a value greater than 100, but do not worry about this!). With the display in this mode, the central “:” cursor will flash once for every echo received, which under normal circumstances will be approximately once per second.

TIP: It is useful at this point to check that the maximum echo size available is being received. Adjust the position of the instrument until the highest echo size is shown continually. In most applications, the signal strength will vary over a wide range : 20 – 80.

Press blue button  now to return to the original level reading and to start the calibration routine.





Note that the output of the MSP422 will vary during programming as the various default values are changed. The display will automatically revert to the level or distance reading from any other display after a period of 4 minutes.

4.2.3 Setting the correct bottom reference (b.rEF).

- a) Press green button  and the display will scroll from the level reading to “b.rEF”.
- b) Press blue button  to enter the editing menu for b.rEF. The display will show the present value of the b.rEF parameter.
- c) If this value is correct, press red button , then green button  to scroll on to the next menu option. (4.2.4 below).

Or

To change the value, press blue button  to edit :-

The first digit of the display will flash and may be changed using green button . Once correct, press blue button  to select the next digit and then green button  to edit, or the blue button  again to move to the next digit. Continue this sequence until all 4 digits are correct, then press the blue button  a final time to confirm the new b.rEF value (none of the digits should now be flashing)



If the new value is incorrect, the edit sequence for b.rEF can be started again by pressing the blue button .

If the new value is correct, press the red button  to save the b.rEF programmed in and the display will automatically scroll on to the 4mA (4) setting menu.

4.2.4 Setting the 4 and 20mA levels. (4 & 20)





The 4mA level may be set above or below the 20mA level to suit the monitoring or control equipment.

If you wish to set the 4 and 20mA levels by ranging the MSP422 to a fixed target, such as the level in the tank at any particular time, skip these menu options by pressing the green button  2 times to arrive at the set damping option.

- a) Press the blue button  to enter the editing menu for the 4mA level. The display will show the present value of the 4mA level.
- b) If this value is correct, press the red button , then the green button  to scroll on to the next menu option.



Or

Press the blue button  to edit this value :-

The first digit of the display will flash and may be changed using green button  . Once correct, press blue button  to select the next digit and then green button  to edit, or the blue button  again to move to the next digit. Continue this sequence until all 4 digits are correct, then press the blue button  a final time to confirm the new 4mA value (none of the digits should now be flashing)





If the new value is incorrect, the edit sequence for 4mA can be started again by pressing the blue button  .

If the new value is correct, press the red button  to save the 4mA level programmed in and the display will automatically scroll on to the 20mA (20) setting menu.

- a) Press the blue button  to enter the editing menu for the 20mA level. The display will show the present value of the 20mA parameter.
- b) If this value is correct, press the red button  , then the green button  to scroll on to the next menu option.

Or,

Press the blue button  to edit this value :-

The first digit of the display will flash and may be changed using green button  . Once correct, press blue button  to select the next digit and then green button  to edit, or the blue button  again to move to the next digit. Continue this sequence until all 4 digits are correct, then press the blue button  a final time to confirm the new 20mA value (none of the digits should now be flashing)



If the new value is incorrect, the edit sequence for 20mA can be started again by pressing the blue button  .

If the new value is correct, press the red button  to save the 20mA level programmed in and the display will automatically scroll on to the damping (d) setting menu.

4.2.5 Setting the damping applied to the output (d).





The damping value entered is actually a time constant in seconds which is applied as smoothing to the level reading and the output current. A new value may be entered up to a value of 999 seconds. A large value will have the effect of smoothing out rapid changes of level and will also smooth out the effects of turbulence and ripples on the liquid surface. (It would be highly unusual to select a value greater than 30 seconds.)

You may choose to enter a value of zero, in which case no smoothing will be applied to the current output and changes in reading immediately change the current output. (note, as the MSP422 transmits at nominally once per second, a damping time of zero will not necessarily give an immediate response).

- a) Press the blue button  to enter the editing menu for the damping time . The display will show the present value of damping.
- b) If this value is correct, press the red button  , then the green button  to scroll on to the next menu option.

Or

Press the blue button  to edit this value :-

The first digit of the display will flash and may be changed using green button  . Once correct, press blue button  to select the next digit and then green button  to edit, or the blue button  again to move to the next digit. Continue this sequence until all 3 digits are correct, then press the blue button  a final time to confirm the new damping value (none of the digits should now be flashing)

If the new value is incorrect, the edit sequence for damping can be started again by pressing the blue button  .





If the new value is correct, press the red button  to save the damping value programmed in and the display will automatically scroll on to the alarm action menu. (AL)

4.2.6 Selecting the output current action on alarm condition.

The MSP422 will signal an alarm condition in the event that the target echo is lost for a period of 10s or more.

The user can select what action the current output will take in this case.



- | | |
|------|--|
| Hi | The current on the two wire loop will drive up to 21 mA and remain there until the correct target echo is recovered. The display will flash "LE" and the last reading. |
| Hold | The current will freeze at the value it was last reading and will remain there until the correct target echo is recovered. The display will flash "LE" and the last reading. |
| Lo | The current on the two wire loop will drive down to 3.6 mA and remain there until the correct target echo is recovered. The display will flash "LE" and the last reading. |



To change the action from the default action Hold, enter the menu using, the blue button  to show the current action. Press blue button  to enter edit mode. With the display flashing use green button  to display the required action and then press blue button  to select this action and the display will stop flashing. Press red button  to save and scroll on to the menu that allows setting of the 4mA and 20mA levels against a known target.



4.2.7 Setting the 4 and 20mA levels using actual liquid levels in the tank (S-4 and S-20).



If you have already programmed the 4 and 20mA levels as above, you do not need to enter this menu. All the programming is now complete and you should press the green button  to move to the final "Lrn" option in the main menu.

If, however, you wish to set the 4 or 20mA level by ranging the instrument to a known target – perhaps the level in the vessel at this time – then press the blue button  to enter this menu.

The first option is to set the 4mA level. Ensure the target is at the desired 4mA level and, with the display reading the new value, press the blue button . The display will show the present value for the 4mA setting. Press the blue button  again to edit the 4mA level, and the display will alternately flash “4” with the current level reading.

Press blue button  to confirm the correct value for the 4mA level then press red button  to save and exit to the 20mA setting menu.

To set the 20mA level, ensure that the target is at the desired 20mA level and, with the display reading the new value, press the blue button . The display will show the present value for the 20mA setting. Press the blue button  again to edit the 20mA level, and the display will alternately flash “20” with the current level reading.



Press blue button  to confirm the correct value for the 20mA level then press red button  to save and exit to the "Lrn" menu.

4.2.8 Blocking unwanted echoes from false targets

The MSP422 has an easy to use “Lrn” (Learn) routine which allows the user to teach the instrument up to 2 false echoes and then ignore them in future operation.

If the application is straight forward and there are no false echoes, press the green button  now to exit the programming menu and return the instrument to normal operation, showing the level reading on the display.

If, once the MSP422 is in operation, an echo other than the true liquid surface echo is detected, and an incorrect level reading is displayed, the instrument can be taught to ignore this false echo. This routine may be used at any time, either during or after set-up or should a problem occur later.

Press blue button  to enter the Lrn menu. The display will show “LrnX”, where X is 0, 1 or 2 and is the number of false target echoes already stored. To store a new false echo, press the blue button  for greater than 5s.

Note : If there are already 2 false echoes stored (Lrn2) then the MSP422 will not allow the user to store another echo until the memory is cleared. (see below)

The display will now flash the false target position alternating with "Lrn". After 4s the false target is stored and the display shows "LrnX". If for any reason this target is not to be saved then press the blue button  and the "Lrn" sequence may be repeated or aborted.

Otherwise, press the red button  to save the false target echo and return to the main menu.

To store another false target echo, navigate down the main menu to "Lrn" and repeat the sequence again.

Note :-

When a false target echo is stored, the MSP422 effectively sets up a 'window' around the false target and will ignore any echo from within that window unless the echo from the liquid surface is larger than that from the false target.

The user may therefore see no change in the MSP422 output current whilst the liquid level moves through this window, which is equivalent to a distance of around 200mm.

To clear the MSP422 of all false echoes stored, simply press blue button  to enter the Lrn menu then with the display showing "LrnX" press the green button  for 10s to completely clear the memory. The display will now show "Lrn0".

4.2.9 Changing operation to distance mode

If the MSP422 is to be used to measure distance rather than level, the display can now be changed accordingly. With the display showing the level reading, press the blue button , the display will now show the distance to target alternating with "Dist".

Note : The display will continue to alternate between the distance to target and "Dist" whilst in distance mode.

4.3 Power failure

All parameters are held in E²PROM memory, so in the event of a power failure or disconnection from the power supply the MSP422 will remember all of its last parameter values and will resume correct operation once power is restored.

4.4 Final checks

Check the display is reading correctly.

You may wish to check echo size again before re-fitting the enclosure lid.

Check that the cover seal is in place in the cover and is good condition. It should not be twisted or kinked in any way.

Carefully set the cover on the MSP422 with the text on the cover label at right angles to the conduit entry, and tighten the three cover screws equally to seal the instrument.

Check that the cable gland is securely tightened and sealing on the cable sheath.

5.0 FAULT FINDING & ERROR MESSAGES

5.1 No display :

Check power supply. Ensure a minimum of 12v dc at the instrument terminals. Check cable insulation is not preventing contact at the terminal block.

5.2 No level reading :

Check instrument is pulsing. You should be able to hear the transducer “ticking” about once per second. If there is no sound, the instrument should be replaced.

5.3 Error messages

5.3.1 Flashing “LE” with “0000”. This means that the MSP422 is not receiving a return echo possibly because the liquid surface is poor or beyond the range (8m/26ft) of the instrument. Re-locate the instrument or contact Solartron Mobrey for details of longer range instruments.

5.3.2 Flashing “LE” with a level reading. This means that the MSP422 is no longer receiving satisfactory echoes from the liquid surface. This may be because of one of a variety of reasons, for example, excessive foaming, turbulence or ullage vapours. First, check that the instrument transmit face is free from contamination and condensation. The MSP422 will operate with some condensation on the face, but excessive condensation may cause operational problems. If the vessel can not be adequately vented to prevent condensation forming, contact Solartron Mobrey for alternative solutions.

Check the instrument is still vertically aligned above the liquid surface, then check the echo received size. If the echo size is small (<3), re-locate the transducer or modify the vessel so that the MSP422 can operate above a more acceptable area of the liquid surface.

Lost echo (LE) will not be signalled until there has been no return echo for a 10 second period. Within the 10 seconds, the output will remain fixed. If the 10 seconds elapses and no satisfactory has been received, the output will drive to the current level selected and the display will flash the last valid level reading alternately with “LE”.

If, however, a satisfactory echo is received within the 10 seconds, a new output is established and the LE timer is re-set.

6.0 MAINTENANCE AND SPARE PARTS

The only maintenance required is to check the instrument transmit face occasionally to ensure it remains clean.

There are no spare parts for the MSP422. If a problem persists, contact Solartron Mobrey for advice or a replacement unit.

7.0 PARAMETER DEFAULT VALUES

Parameter	MSP422-B28 (Metric)	MSP422-N28 (Imperial)
Measuring units	metres	feet
Display reading	level	level
Bottom reference	8	26.24
4 mA level	0	0
20mA level	7.5	14.76
Damping	10s	10s

8.0 PROGRAMMING MENU

MSP422 Programming Menu IP2013/PM

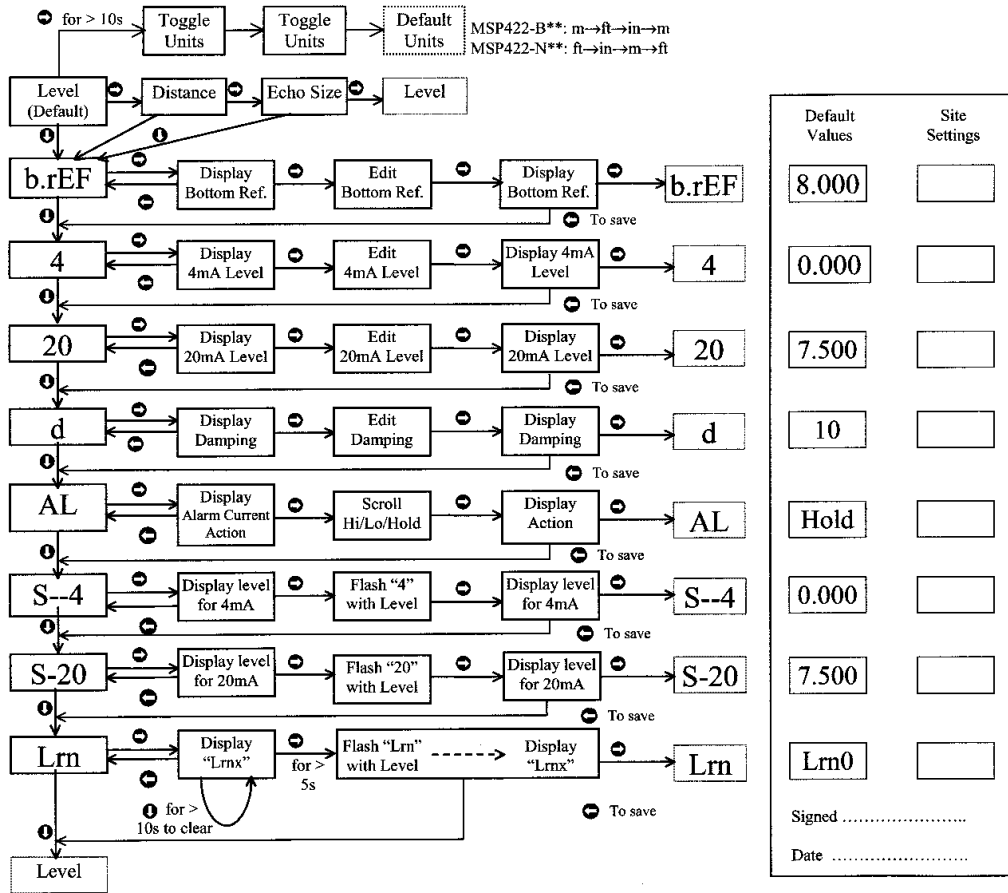

Solartron Mobrey Limited

158 Edinburgh Avenue Slough Berks England SL1 4UE
Tel: 01753 756600 Fax: 01753 823589
e-mail: sales@solartron.com www.solartronmobrey.com



a Roxboro Group Company

Solartron Mobrey GmbH	Deutschland	tel: 0211/99 808-0
Solartron Mobrey Ltd	China	tel: 021 6353 5652
Mobrey sp z o o	Polska	tel: 022 871 7865
Solartron Mobrey AB	Sverige	tel: 08-725 01 00
Mobrey SA	France	tel: 01.34.30.28.30
Mobrey SA-NV	Belgium	tel: 02/465 3879
Solartron Mobrey	USA	tel: (281) 398 7890



The right is reserved to amend details given in this publication without notice