



Connectors > Rectangular Connectors > Standard Rectangular Connectors



Connector Product Type: **Housing**

Connector & Housing Type: **Receptacle**

Mating Retention Type: **Locking**

Connector System: **Wire-to-Board**

UL Flammability Rating: **UL 94V-0**

## Features

### Product Type Features

Connector Product Type	Housing
Connector & Housing Type	Receptacle
Connector System	Wire-to-Board
Connector & Contact Terminates To	Wire & Cable

### Configuration Features

Number of Positions	4
Number of Rows	2

### Electrical Characteristics

Operating Voltage	250 VAC
-------------------	---------

### Body Features

Primary Product Color	Green
-----------------------	-------

### Contact Features

Contact Type	Socket
Contact Current Rating (Max)	3 A

### Termination Features

Termination Method to Wire & Cable	Crimp
------------------------------------	-------

### Mechanical Attachment

--	--



Strain Relief	With
Mating Retention Type	Locking
Mating Retention	With
Connector Mounting Type	Cable Mount (Free-Hanging)

### Housing Features

Housing Entry Configuration	Both Ends Closed
Centerline (Pitch)	2.54 mm [.1 in]
Housing Material	Polyamide 6.6 GF

### Dimensions

	4.99 in
Row-to-Row Spacing	2.54 mm [.1 in]

### Usage Conditions

Operating Temperature Range	-65 – 105 °C [-85 – 221 °F]
-----------------------------	-----------------------------

### Operation/Application

Circuit Application	Signal
---------------------	--------

### Industry Standards

Glow Wire Rating	Standard Part - Not Glow Wire
UL Flammability Rating	UL 94V-0

### Packaging Features

Packaging Quantity	50
--------------------	----

## Product Compliance







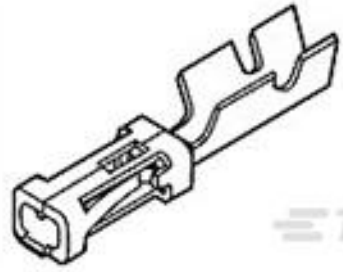
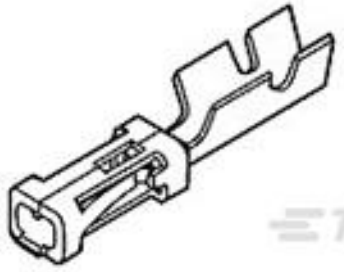

[For compliance documentation, visit the product page on TE.com>](#)

EU RoHS Directive 2011/65/EU	Compliant
EU ELV Directive 2000/53/EC	Compliant
China RoHS 2 Directive MIIT Order No 32, 2016	No Restricted Materials Above Threshold
EU REACH Regulation (EC) No. 1907/2006	Current ECHA Candidate List: JAN 2025 (247) Candidate List Declared Against: JAN 2025 (247) Does not contain REACH SVHC
Halogen Content	BFR/CFR/PVC Free, but Br/Cl >900 ppm in other sources.
Solder Process Capability	Not applicable for solder process capability

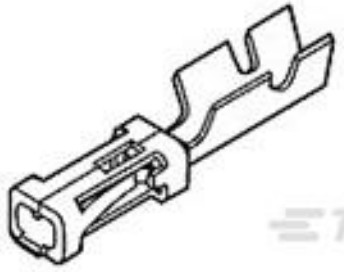
Product Compliance Disclaimer

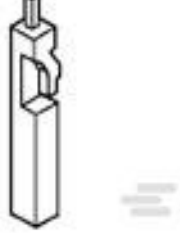
This information is provided based on reasonable inquiry of our suppliers and represents our current actual knowledge based on the information they provided. This information is subject to change. The part numbers that TE has identified as EU RoHS compliant have a maximum concentration of 0.1% by weight in homogenous materials for lead, hexavalent chromium, mercury, PBB, PBDE, DBP, BBP, DEHP, DIBP, and 0.01% for cadmium, or qualify for an exemption to these limits as defined in the Annexes of Directive 2011/65/EU (RoHS2). Finished electrical and electronic equipment products will be CE marked as required by Directive 2011/65/EU. Components may not be CE marked. Additionally, the part numbers that TE has identified as EU ELV compliant have a maximum concentration of 0.1% by weight in homogenous materials for lead, hexavalent chromium, and mercury, and 0.01% for cadmium, or qualify for an exemption to these limits as defined in the Annexes of Directive 2000/53/EC (ELV). Regarding the REACH Regulation, the information TE provides on SVHC in articles for this part number is based on the latest European Chemicals Agency (ECHA) 'Guidance on requirements for substances in articles' posted at this URL: <https://echa.europa.eu/guidance-documents/guidance-on-reach>

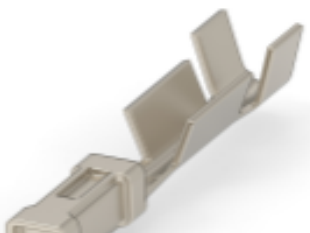
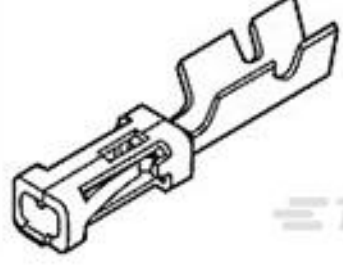
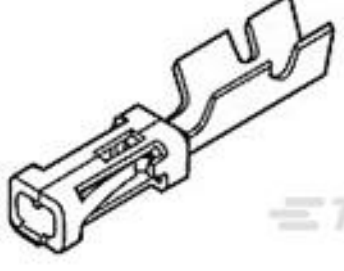
## Compatible Parts

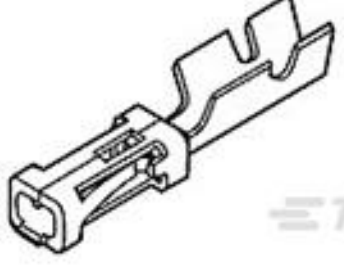
 <p>TE Part # 167300-5 MOD-4 REC.CONTACT</p>	 <p>TE Part # 167024-1 MOD-4 REC.CONT.SCP.</p>	 <p>TE Part # 2-167301-2 MOD-4 REC.CONT.SCP</p>	 <p>TE Part # 166310-3 MOD-5 REC.CONTACT</p>
 <p>TE Part # 825457-2 MOD 2 PINHDR 2X02P.</p>	 <p>TE Part # 926519-2 KEYING PLUG</p>	 <p>TE Part # 167300-6 MOD-4 REC.CONTACT</p>	 <p>TE Part # 141708-1 MOD-4 REC.CONT.SCP.</p>
 <p>TE Part # 166310-2 MOD-5 REC.CONTACT</p>	 <p>TE Part # 167300-8 MOD-4 REC.CONTACT</p>	 <p>TE Part # 1-926519-1 KODIERTEIL F MOD4</p>	 <p>TE Part # 167300-7 MOD 4 REC.CONTACT</p>

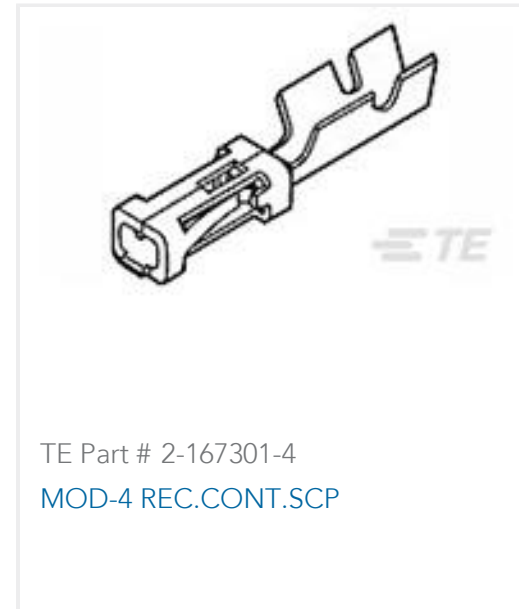
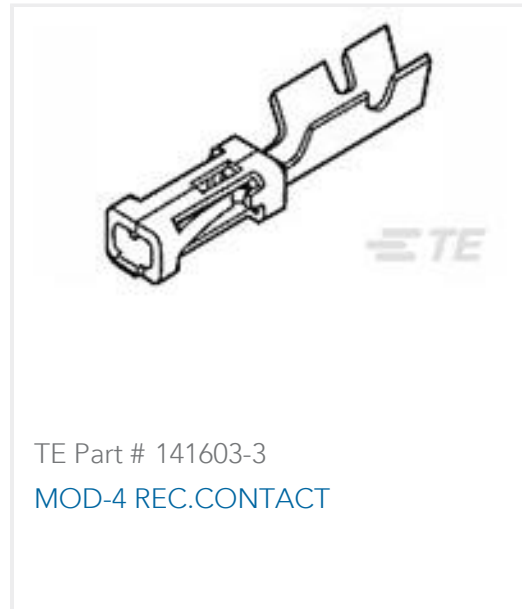

Also in the Series | AMPMODU IV/V

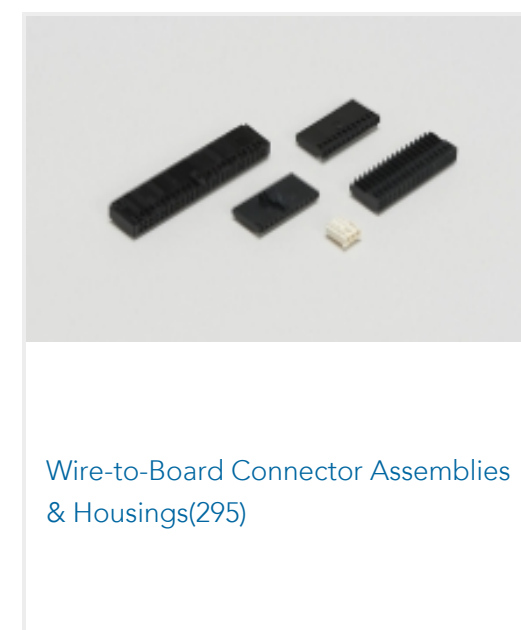
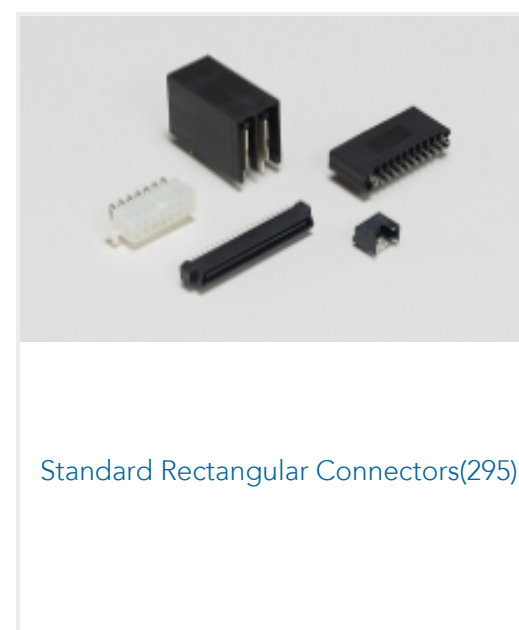
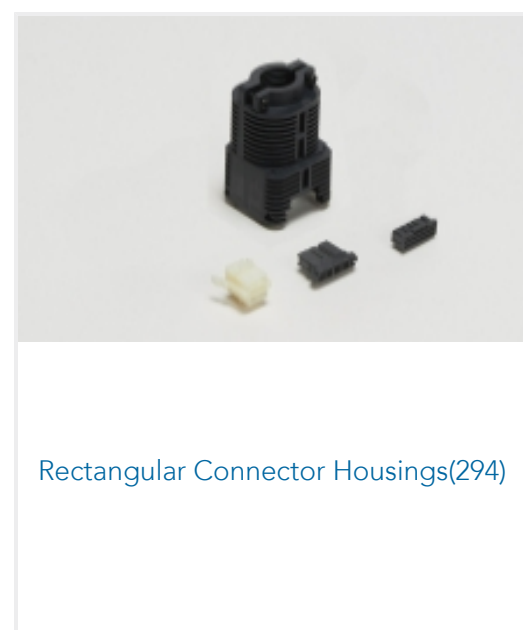
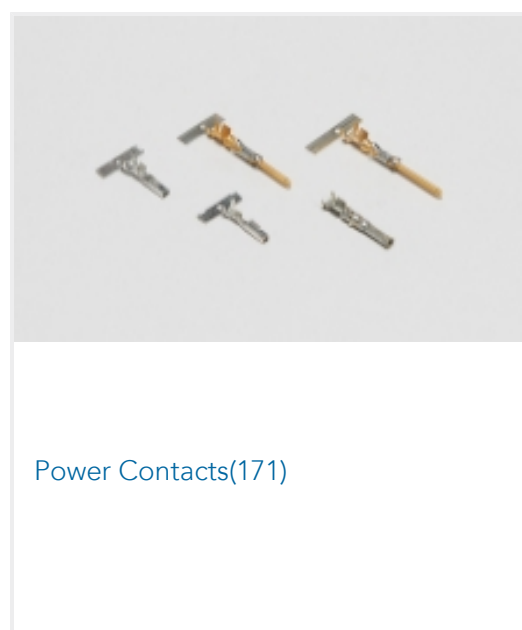
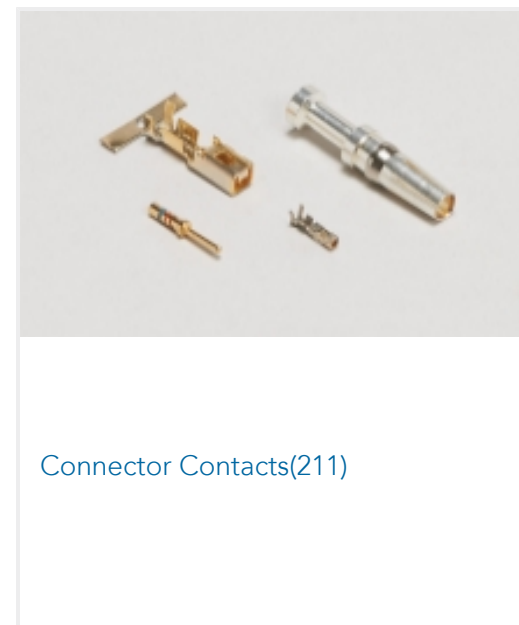
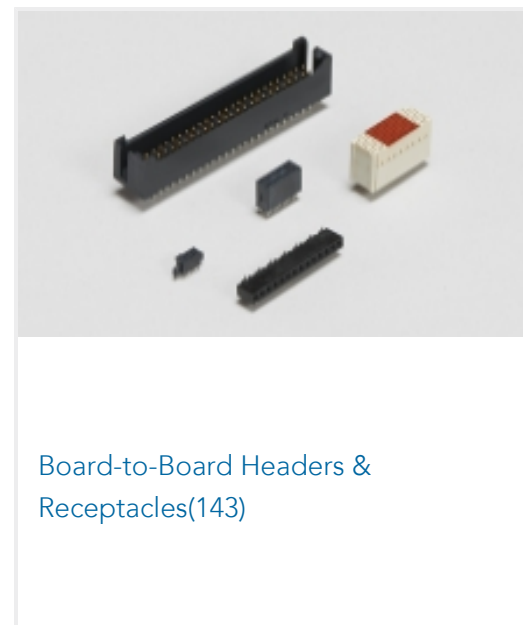
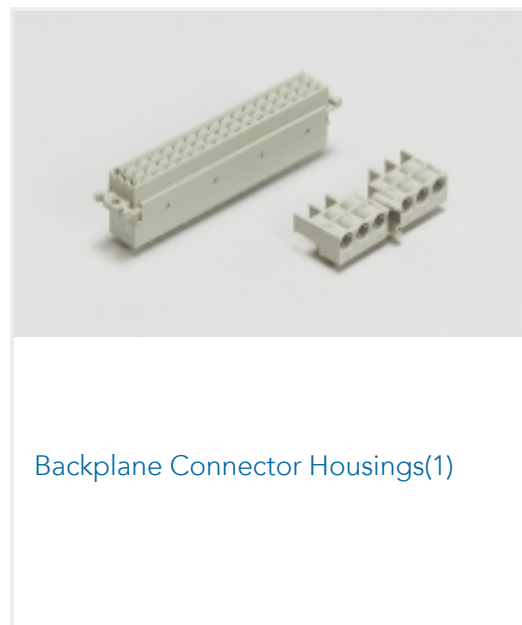

Customers Also Bought

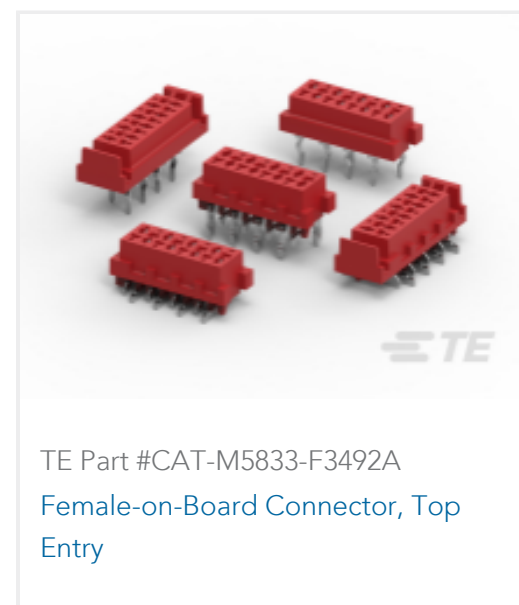
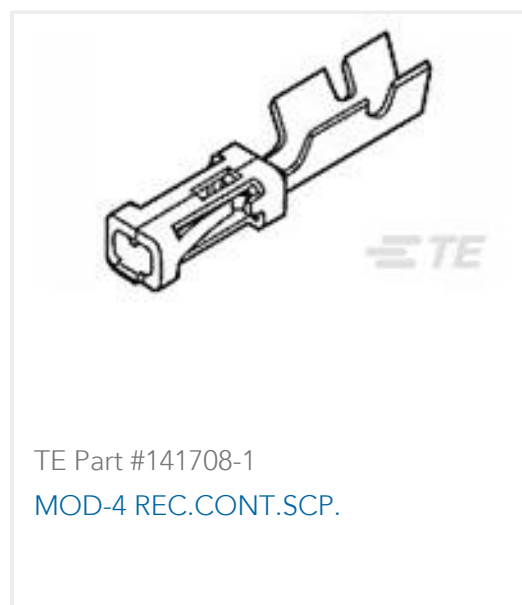



## Documents

### Product Drawings

[MOD IV REC HSG, 2X2P](#)

English

### CAD Files

[3D PDF](#)

3D

Customer View Model

[ENG\\_CVM\\_CVM\\_925370-2\\_AA.2d\\_dxf.zip](#)

English

Customer View Model

[ENG\\_CVM\\_CVM\\_925370-2\\_AA.3d\\_igs.zip](#)

English

Customer View Model

[ENG\\_CVM\\_CVM\\_925370-2\\_AA.3d\\_stp.zip](#)

English

By downloading the CAD file I accept and agree to the [Terms and Conditions](#) of use.

### Product Specifications

[Application Specification](#)

English

### Agency Approvals

[UL Report](#)

English