

FPF1007-FPF1009 IntelliMAX™ Advanced Load Products

Features

- 1.2 to 5.5 V Input Voltage Range
- Typical $R_{ON} = 30\text{ m}\Omega$ at $V_{IN} = 5.5\text{ V}$
- Typical $R_{ON} = 40\text{ m}\Omega$ at $V_{IN} = 3.3\text{ V}$
- Fixed Three Different Turn-on Rise Time $10\text{ }\mu\text{s} / 80\text{ }\mu\text{s} / 1\text{ ms}$
- Low $< 10\text{ }\mu\text{A}$ at $V_{IN} = 3.3\text{ V}$ Quiescent Current
- Internal ON Pin Pull Down
- Output Discharge Function
- ESD Protection above 8000 V HBM and 2000 V CDM
- RoHS Compliant

Applications

- PDAs
- Cell Phones
- GPS Devices
- MP3 Players
- Digital Cameras
- Peripheral Ports
- Hot-Swap Supplies
- Notebook Computers



General Description

The FPF1007/8/9 are low R_{DS} P-Channel MOSFET load switches offered in a selection of $10\text{ }\mu\text{s}$, $80\text{ }\mu\text{s}$, and 1 ms slew rate turn-on options for transient / in-rush current control. To support trends in mobile application requirements, the minimum operating input voltage has been reduced down to 1.2 V , the input current leakage has been minimized to extend battery life, and the ESD-protection has been designed to withstand a minimum of 8 kV (HBM) and 2 kV (CDM).

The switch is controlled by an active-high logic input (ON pin), allowing direct interface with a low-voltage control signal. An internal ON pin pull-down resistor protects against unintentional device turn-on in the initial state. An on-chip pull-down resistor on the output is enabled when the switch is turned-off and provides quick, robust discharge of the output load.



Ordering Information

Part	Switch R_{ON} at 5.5 V [Typ.]	Rise Time [Typ.]	Output Discharge [Typ.]	ON Pin Activity
FPF1007	$30\text{ m}\Omega$, PMOS	$10\text{ }\mu\text{s}$	$60\text{ }\Omega$	Active HIGH
FPF1008	$30\text{ m}\Omega$, PMOS	$80\text{ }\mu\text{s}$	$60\text{ }\Omega$	Active HIGH
FPF1009	$30\text{ m}\Omega$, PMOS	1 ms	$60\text{ }\Omega$	Active HIGH

Typical Application Circuit

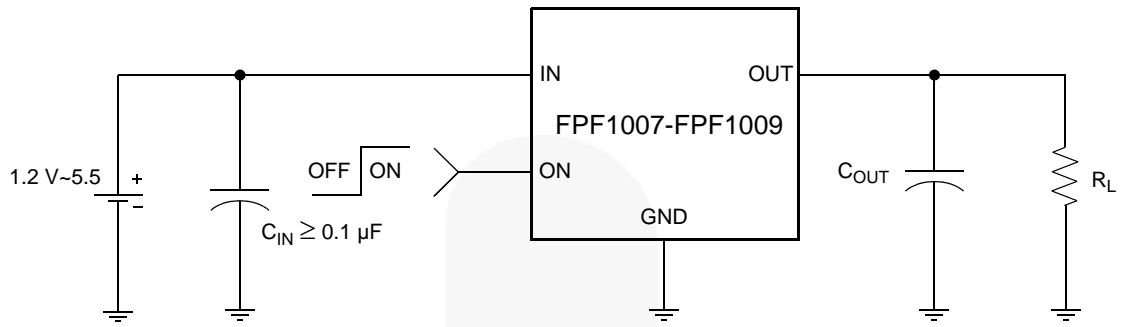

Functional Block Diagram

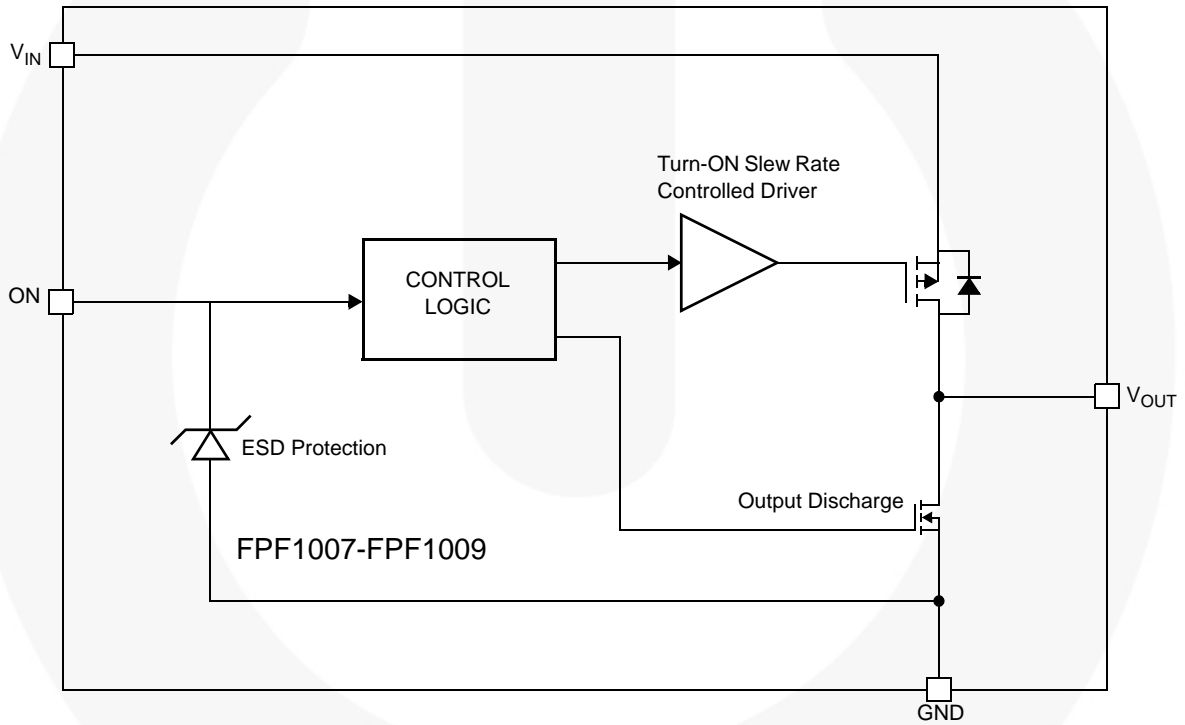

Pin Configuration

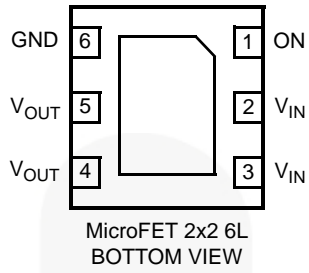

Pin Description

Pin	Name	Function
4, 5	V_{OUT}	Switch Output: Output of the power switch
2, 3	V_{IN}	Supply Input: Input to the power switch and the supply voltage for the IC
6	GND	Ground
1	ON	ON/OFF Control Input

Absolute Maximum Ratings

Parameter	Min.	Max.	Unit
V_{IN} , V_{OUT} , ON to GND	-0.3	6.0	V
Maximum Continuous Switch Current		1.5	A
Power Dissipation at $T_A = 25^\circ\text{C}^{(1)}$		1.2	W
Storage Junction Temperature	-65	+150	$^\circ\text{C}$
Operating Temperature Range	-40	+85	$^\circ\text{C}$
Thermal Resistance, Junction to Ambient		86	$^\circ\text{C/W}$
Electrostatic Discharge Protection	HBM	8000	V
	CDM	2000	V

Note:

Package power dissipation on 1-square inch pad, 2 oz. copper board.

Recommended Operating Range

Parameter	Min.	Max.	Unit
V_{IN}	1.2	5.5	V
Ambient Operating Temperature, T_A	-40	+85	$^\circ\text{C}$



Electrical Characteristics

$V_{IN} = 1.2\text{ V to } 5.5\text{ V}$, $T_A = -40\text{ to } +85^\circ\text{C}$ unless otherwise noted. Typical values are at $V_{IN} = 3.3\text{ V}$ and $T_A = 25^\circ\text{C}$.

Parameter	Symbol	Conditions	Min.	Typ.	Max.	Units
Basic Operation						
Operating Voltage	V_{IN}		1.2		5.5	V
Quiescent Current	I_Q	$I_{OUT} = 0\text{ mA}$, $V_{IN} = 3.3\text{ V}$, $V_{ON} = \text{Enabled}$		8		μA
		$I_{OUT} = 0\text{ mA}$, $V_{IN} = 5.5\text{ V}$, $V_{ON} = \text{Enabled}$			15	
Off Supply Current	$I_{Q(\text{off})}$	$V_{ON} = \text{GND}$, $V_{OUT} = \text{OPEN}$			1	μA
Off Switch Current	$I_{SD(\text{off})}$	$V_{ON} = \text{GND}$, $V_{OUT} = \text{GND}$		0.1	1.0	μA
On-Resistance	R_{ON}	$V_{IN} = 5.5\text{ V}$, $I_{OUT} = 200\text{ mA}$, $T_A = 25^\circ\text{C}$		30	40	$\text{m}\Omega$
		$V_{IN} = 3.3\text{ V}$, $I_{OUT} = 200\text{ mA}$, $T_A = 25^\circ\text{C}$		40	55	
		$V_{IN} = 1.5\text{ V}$, $I_{OUT} = 200\text{ mA}$, $T_A = 25^\circ\text{C}$		100	130	
		$V_{IN} = 1.2\text{ V}$, $I_{OUT} = 200\text{ mA}$, $T_A = 25^\circ\text{C}$		175	250	
		$V_{IN} = 3.3\text{ V}$, $I_{OUT} = 200\text{ mA}$, $T_A = -40^\circ\text{C to } +85^\circ\text{C}$	20		65	
Output Pull Down Resistance	R_{PD}	$V_{IN} = 3.3\text{ V}$, $V_{ON} = 0\text{ V}$, $T_A = 25^\circ\text{C}$		60		Ω
ON Input Logic Low Voltage	V_{IL}	$V_{IN} = 1.2\text{ V to } 5.5\text{ V}$			0.4	V
ON Input Logic High Voltage	V_{IH}	$V_{IN} = 1.2\text{ V to } 5.5\text{ V}$	1			V
ON Input Leakage (On)		$V_{ON} = V_{IN} = 5.5\text{ V}$			10	μA
ON Input Leakage (Off)		$V_{ON} = \text{GND}$			1	μA
Dynamic						
FPF1007						
Turn On	t_{ON}	$V_{IN} = 3.3\text{ V}$, $R_L = 500\ \Omega$, $R_{L_CHIP} = 60\ \Omega$, $C_{OUT} = 0.1\ \mu\text{F}$, $T_A = 25^\circ\text{C}$		12		μs
Rise Time	t_R			10		μs
Turn Off	t_{OFF}			40		μs
Fall Time	t_F			15		μs
FPF1008						
Turn On	t_{ON}	$V_{IN} = 3.3\text{ V}$, $R_L = 500\ \Omega$, $R_{L_CHIP} = 60\ \Omega$, $C_{OUT} = 0.1\ \mu\text{F}$, $T_A = 25^\circ\text{C}$		125		μs
Rise Time	t_R			80		μs
Turn Off	t_{OFF}			40		μs
Fall Time	t_F			15		μs
FPF1009						
Turn On	t_{ON}	$V_{IN} = 3.3\text{ V}$, $R_L = 500\ \Omega$, $R_{L_CHIP} = 60\ \Omega$, $C_{OUT} = 0.1\ \mu\text{F}$, $T_A = 25^\circ\text{C}$		2		ms
Rise Time	t_R			1		ms
Turn Off	t_{OFF}			40		μs
Fall Time	t_F			15		μs

Typical Characteristics

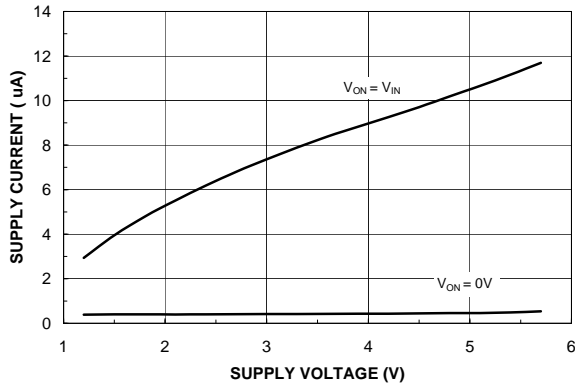

Figure 1. Quiescent Current vs. Input Voltage

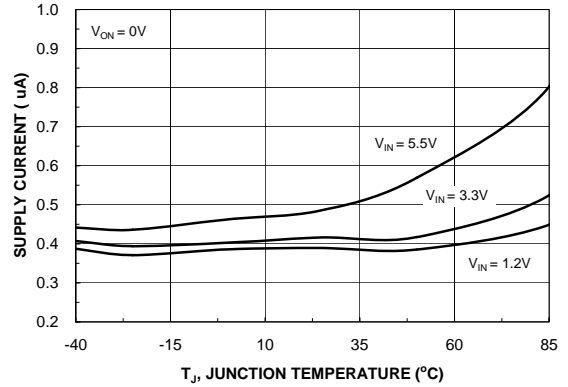

Figure 2. Quiescent Current vs. Temperature

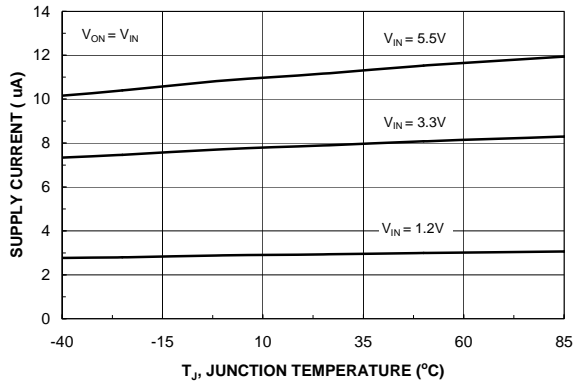

Figure 3. Quiescent Current vs. Temperature

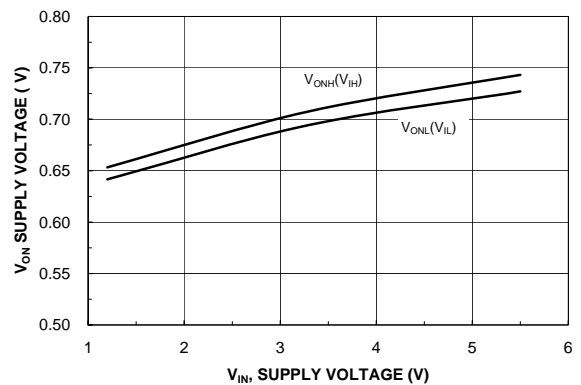

Figure 4. V_{ON} Voltage vs. Input Voltage

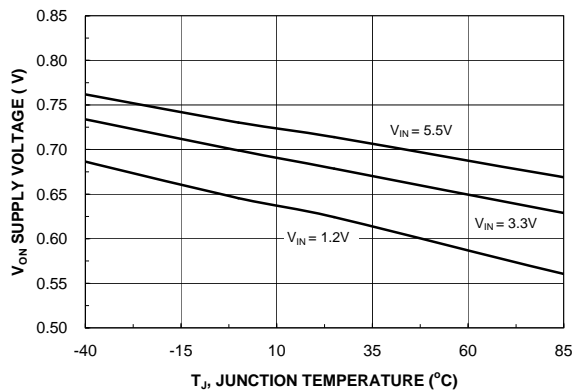

Figure 5. V_{ON} Low Voltage vs. Temperature

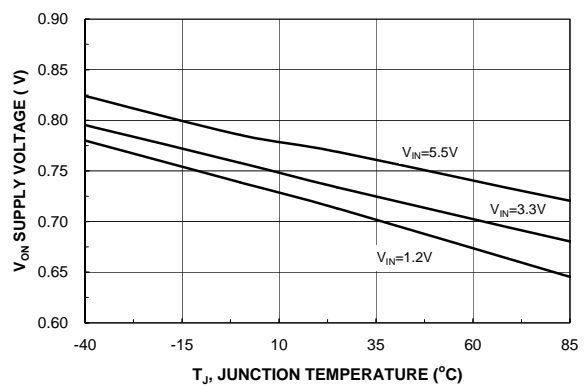

Figure 6. V_{ON} High Voltage vs. Temperature

Typical Characteristics

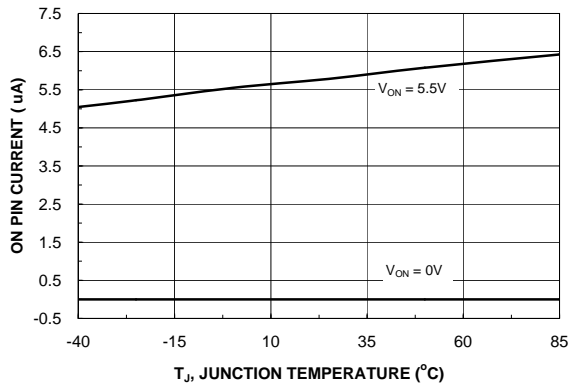

Figure 7. On Pin Current vs. Temperature

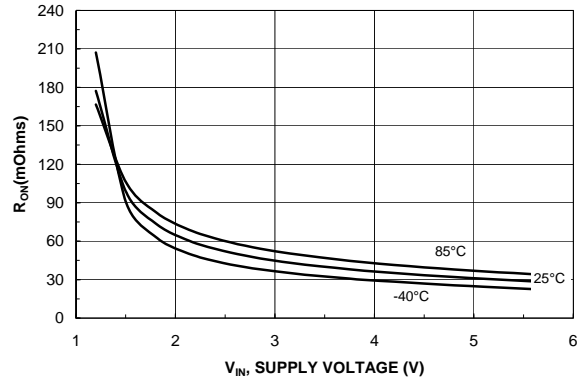

Figure 8. R_{ON} vs. V_{IN}

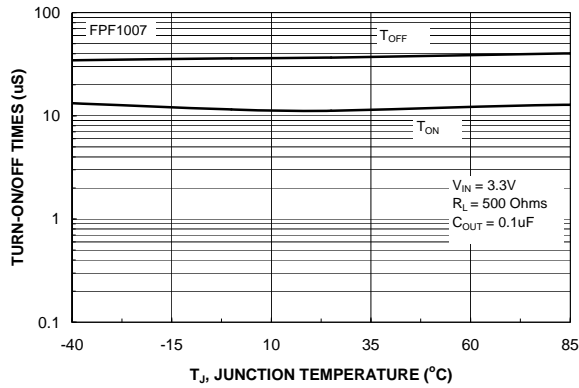

Figure 9. FPF1007 t_{ON} / t_{OFF} vs. Temperature

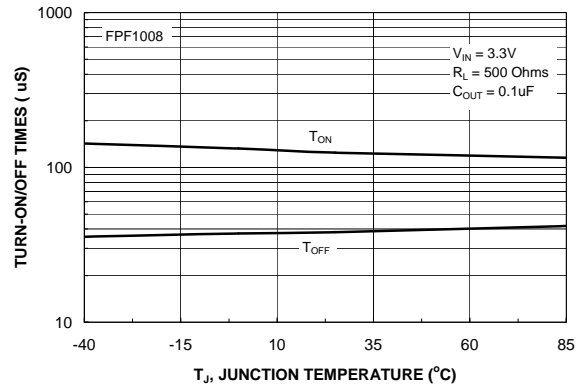

Figure 10. FPF1008 t_{ON} / t_{OFF} vs. Temperature

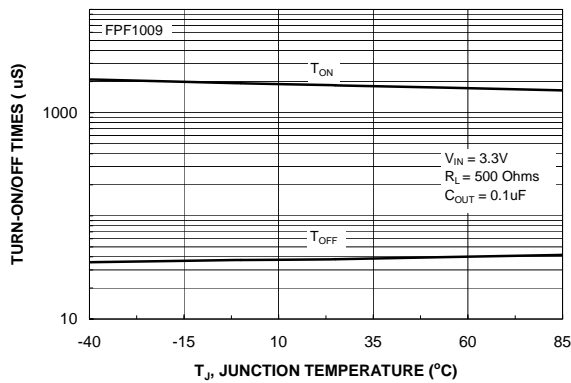

Figure 11. FPF1009 t_{ON} / t_{OFF} vs. Temperature

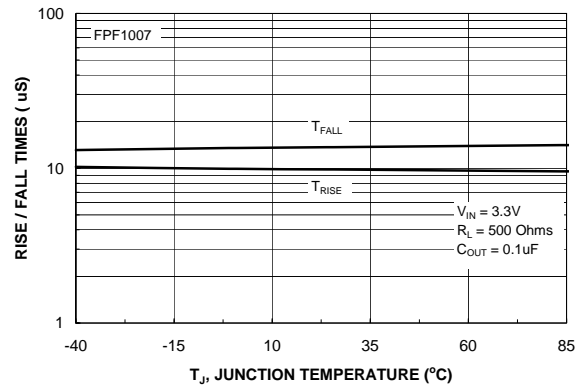

Figure 12. FPF1007 t_{RISE} / t_{FALL} vs. Temperature

Typical Characteristics

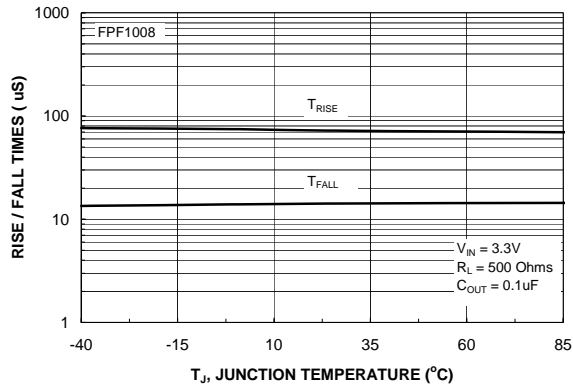

Figure 13. FPF1008 t_{RISE} / t_{FALL} vs. Temperature

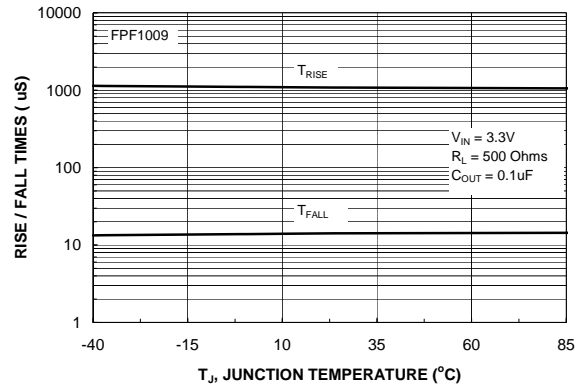

Figure 14. FPF1009 t_{RISE} / t_{FALL} vs. Temperature

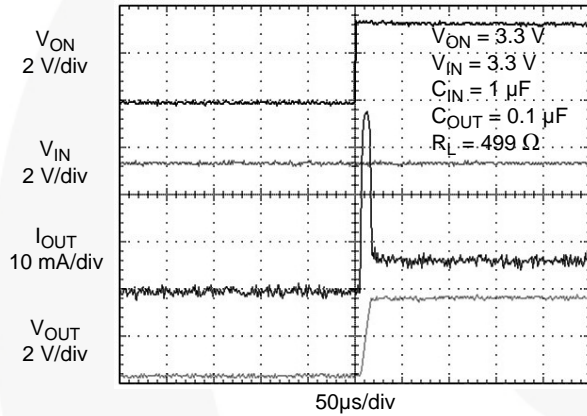

Figure 15. FPF1007 Turn-On Response

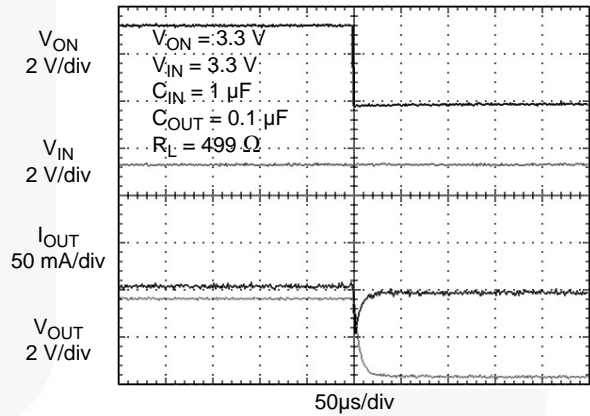

Figure 16. FPF1007 Turn-Off Response
Load current discharged through on-chip output discharge resistor

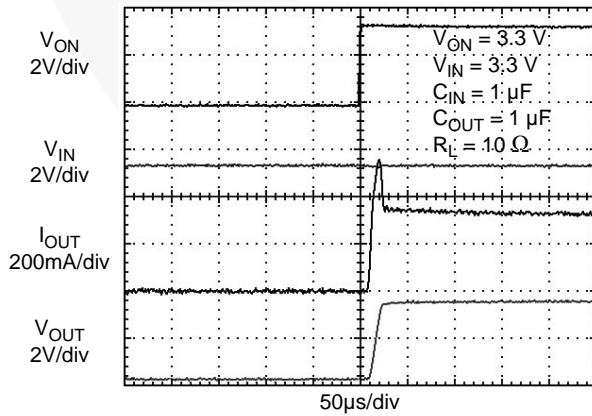

Figure 17. FPF1007 Turn-On Response ($C_{OUT} = 1 \mu F$)

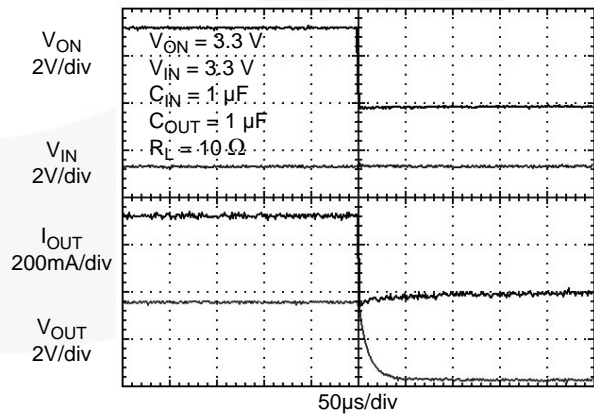

Figure 18. FPF1007 Turn-Off Response

Typical Characteristics

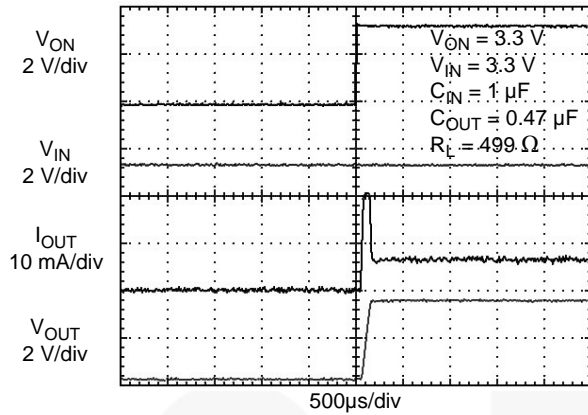

Figure 19. FPF1008 Turn-On Response

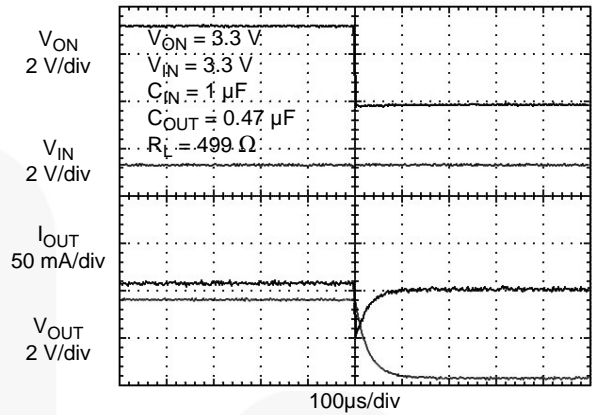

Figure 20. FPF1008 Turn-Off Response
Load current discharged through on-chip output discharge resistor

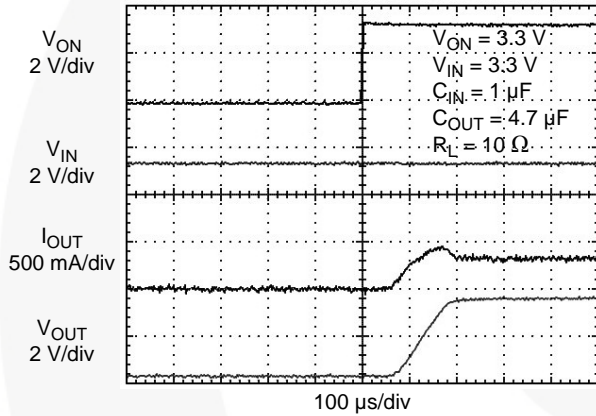

Figure 21. FPF1008 Turn-On Response ($C_{OUT} = 4.7\text{ }\mu\text{F}$)

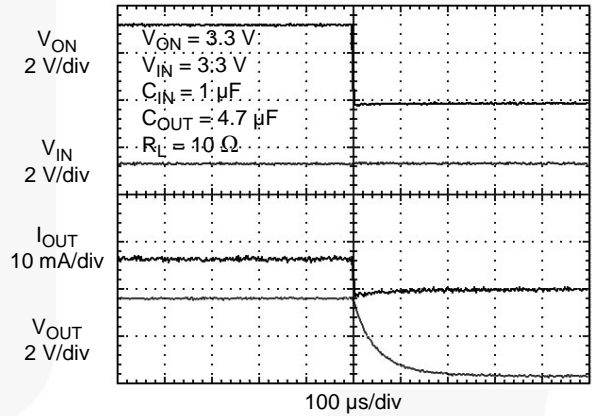

Figure 22. FPF1008 Turn-Off Response

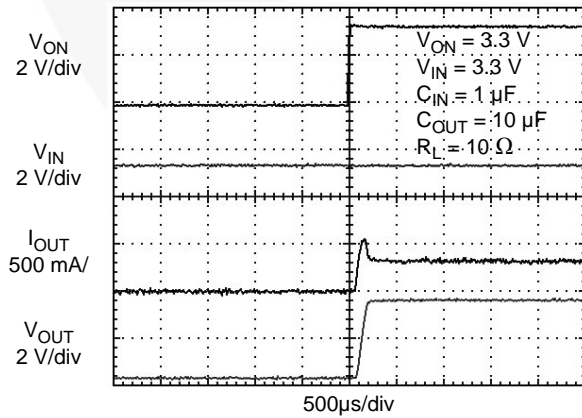

Figure 23. FPF1008 Turn-On Response ($C_{OUT} = 10\text{ }\mu\text{F}$)

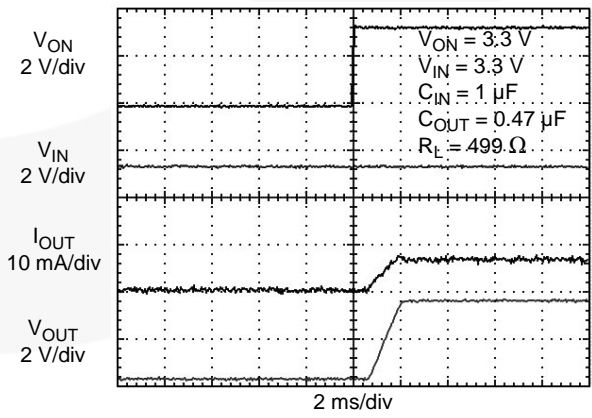

Figure 24. FPF1009 Turn-On Response

Typical Characteristics

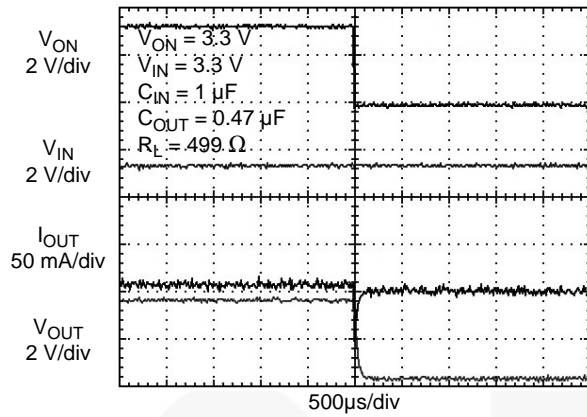

Figure 25. FPF1009 Turn-Off Response
Load current discharged through on-chip output discharge resistor

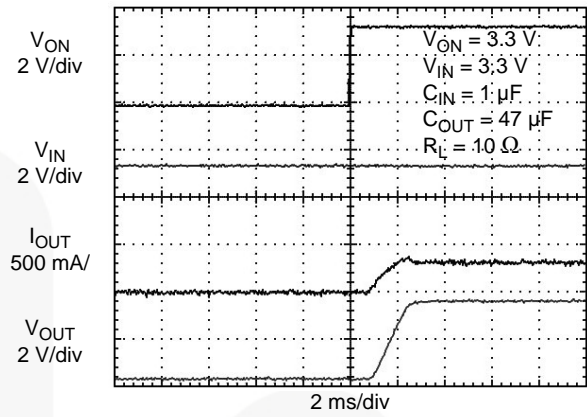

Figure 26. FPF1009 Turn-On Response ($C_{OUT} = 47 \mu F$)

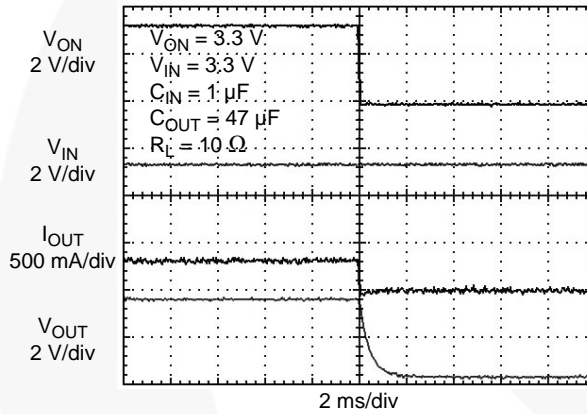

Figure 27. FPF1009 Turn-Off Response

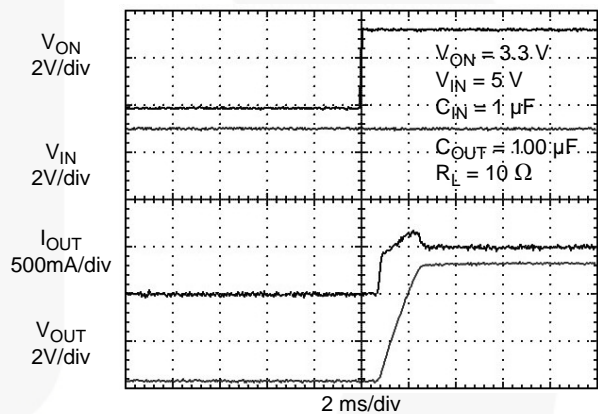
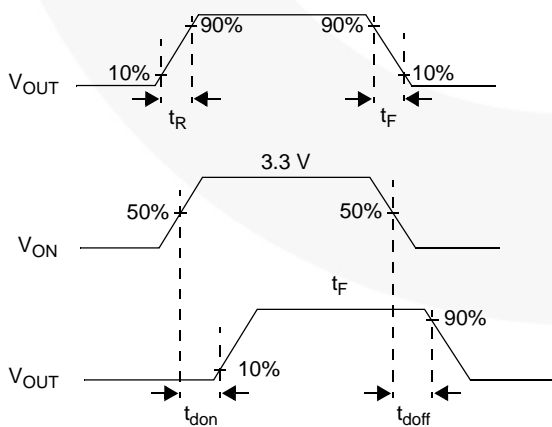

Figure 28. FPF1009 Turn-On Response
($C_{OUT} = 100 \mu F$, $V_{IN} = 5 V$)

Timing Diagram



where:

- t_{ON} = Turn-On Time
- t_{OFF} = Turn-Off Time
- t_{don} = Turn-On Delay Time
- t_{doff} = Turn-Off Delay Time
- t_R = Rise Time
- t_F = V_{OUT} Fall Time
- $t_{ON} = t_R + t_{don}$
- $t_{OFF} = t_F + t_{doff}$

Dimensional Outline and Pad Layout

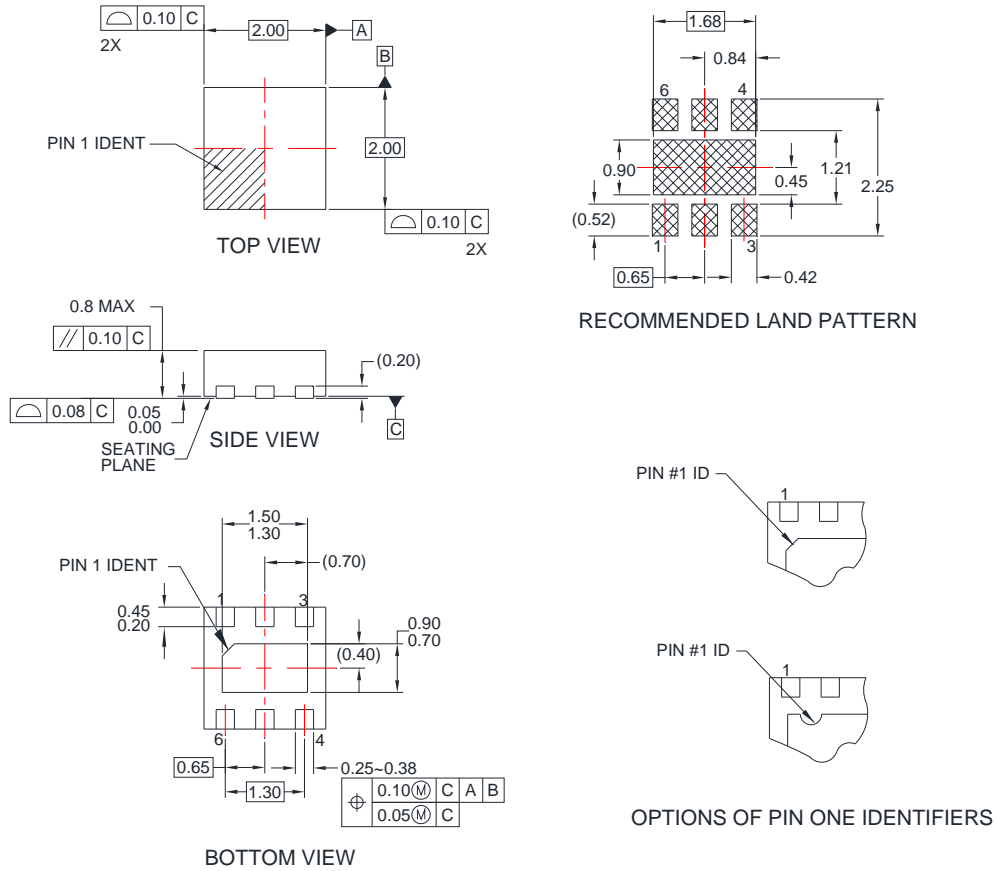

NOTES:

- A. DOES NOT FULLY CONFORM TO JEDEC REGISTRATION, MO-229.
- B. DIMENSIONS ARE IN MILLIMETERS.
- C. DIMENSIONS AND TOLERANCES PER ASME Y14.5M, 1994
- D. LANDPATTERN RECOMMENDATION IS BASED ON FSC DESIGN ONLY
- E. DRAWING FILENAME: MKT-MLP06Krev3.

Package drawings are provided as a service to customers considering Fairchild components. Drawings may change in any manner without notice. Please note the revision and/or date on the drawing and contact a Fairchild Semiconductor representative to verify or obtain the most recent revision. Package specifications do not expand the terms of Fairchild's worldwide terms and conditions, specifically the warranty therein, which covers Fairchild products.

Always visit Fairchild Semiconductor's online packaging area for the most recent package drawings:
<http://www.fairchildsemi.com/packaging/>



TRADEMARKS

The following includes registered and unregistered trademarks and service marks, owned by Fairchild Semiconductor and/or its global subsidiaries, and is not intended to be an exhaustive list of all such trademarks.

2Cool™	F-PFS™	PowerTrench®	The Power Franchise®
AccuPower™	FRFET®	PowerXS™	the power franchise
AX-CAP™*	Global Power Resource™	Programmable Active Droop™	TinyBoost™
BitSiC™	GreenBridge™	QFET®	TinyBuck™
Build it Now™	Green FPS™	QS™	TinyCalc™
CorePLUS™	Green FPS™ e-Series™	Quiet Series™	TinyLogic®
CorePOWER™	Gmax™	RapidConfigure™	TINYOPTO™
CROSSVOLT™	GTO™		TinyPower™
CTL™	IntelliMAX™	Saving our world, 1mW/W/kW at a time™	TinyPwm™
Current Transfer Logic™	ISOPLANAR™	SignalVise™	TinyWire™
DEUXPEED®	Making Small Speakers Sound Louder and Better™	SmartMax™	TranSiC™
Dual Cool™	MegaBuck™	SMART START™	TriFault Detect™
EcoSPARK®	MICROCOUPLER™	Solutions for Your Success™	TRUECURRENT®*
EfficientMax™	MicroFET™	SPM®	μSerDes™
ESBC™	MicroPak™	STEALTH™	
	MicroPak2™	SuperFET®	UHC®
Fairchild®	MillerDrive™	SuperSOT™-3	Ultra FRFET™
Fairchild Semiconductor®	MotionMax™	SuperSOT™-6	UniFET™
FACT Quiet Series™	mWSaver™	SuperSOT™-8	VCX™
FACT®	OptoHIT™	SupreMOS®	VisualMax™
FAST®	OPTOLOGIC®	SyncFET™	VoltagePlus™
FastvCore™	OPTOPLANAR®	Sync-Lock™	XS™
FETBench™			
FlashWriter®*			
FPS™			

* Trademarks of System General Corporation, used under license by Fairchild Semiconductor.

DISCLAIMER

FAIRCHILD SEMICONDUCTOR RESERVES THE RIGHT TO MAKE CHANGES WITHOUT FURTHER NOTICE TO ANY PRODUCTS HEREIN TO IMPROVE RELIABILITY, FUNCTION, OR DESIGN. FAIRCHILD DOES NOT ASSUME ANY LIABILITY ARISING OUT OF THE APPLICATION OR USE OF ANY PRODUCT OR CIRCUIT DESCRIBED HEREIN; NEITHER DOES IT CONVEY ANY LICENSE UNDER ITS PATENT RIGHTS, NOR THE RIGHTS OF OTHERS. THESE SPECIFICATIONS DO NOT EXPAND THE TERMS OF FAIRCHILD'S WORLDWIDE TERMS AND CONDITIONS, SPECIFICALLY THE WARRANTY THEREIN, WHICH COVERS THESE PRODUCTS.

LIFE SUPPORT POLICY

FAIRCHILD'S PRODUCTS ARE NOT AUTHORIZED FOR USE AS CRITICAL COMPONENTS IN LIFE SUPPORT DEVICES OR SYSTEMS WITHOUT THE EXPRESS WRITTEN APPROVAL OF FAIRCHILD SEMICONDUCTOR CORPORATION.

As used herein:

1. Life support devices or systems are devices or systems which, (a) are intended for surgical implant into the body or (b) support or sustain life, and (c) whose failure to perform when properly used in accordance with instructions for use provided in the labeling, can be reasonably expected to result in a significant injury of the user.
2. A critical component in any component of a life support, device, or system whose failure to perform can be reasonably expected to cause the failure of the life support device or system, or to affect its safety or effectiveness.

ANTI-COUNTERFEITING POLICY

Fairchild Semiconductor Corporation's Anti-Counterfeiting Policy. Fairchild's Anti-Counterfeiting Policy is also stated on our external website, www.fairchildsemi.com, under Sales Support.

Counterfeiting of semiconductor parts is a growing problem in the industry. All manufacturers of semiconductor products are experiencing counterfeiting of their parts. Customers who inadvertently purchase counterfeit parts experience many problems such as loss of brand reputation, substandard performance, failed applications, and increased cost of production and manufacturing delays. Fairchild is taking strong measures to protect ourselves and our customers from the proliferation of counterfeit parts. Fairchild strongly encourages customers to purchase Fairchild parts either directly from Fairchild or from Authorized Fairchild Distributors who are listed by country on our web page cited above. Products customers buy either from Fairchild directly or from Authorized Fairchild Distributors are genuine parts, have full traceability, meet Fairchild's quality standards for handling and storage and provide access to Fairchild's full range of up-to-date technical and product information. Fairchild and our Authorized Distributors will stand behind all warranties and will appropriately address any warranty issues that may arise. Fairchild will not provide any warranty coverage or other assistance for parts bought from Unauthorized Sources. Fairchild is committed to combat this global problem and encourage our customers to do their part in stopping this practice by buying direct or from authorized distributors.

PRODUCT STATUS DEFINITIONS

Definition of Terms

Datasheet Identification	Product Status	Definition
Advance Information	Formative / In Design	Datasheet contains the design specifications for product development. Specifications may change in any manner without notice.
Preliminary	First Production	Datasheet contains preliminary data; supplementary data will be published at a later date. Fairchild Semiconductor reserves the right to make changes at any time without notice to improve design.
No Identification Needed	Full Production	Datasheet contains final specifications. Fairchild Semiconductor reserves the right to make changes at any time without notice to improve the design.
Obsolete	Not In Production	Datasheet contains specifications on a product that is discontinued by Fairchild Semiconductor. The datasheet is for reference information only.

Rev. I62