



# KTM-WN117A1P

KTM Prime

CONTRAST SENSORS

**SICK**  
Sensor Intelligence.



### Ordering information

Type	Part no.
KTM-WN117A1P	1061787

Other models and accessories → [www.sick.com/KTM\\_Prime](http://www.sick.com/KTM_Prime)



### Detailed technical data

#### Features

<b>Dimensions (W x H x D)</b>	12 mm x 31.5 mm x 21 mm
<b>Sensing distance</b>	12.5 mm
<b>Sensing distance tolerance</b>	± 3 mm
<b>Housing design (light emission)</b>	Rectangular
<b>Light source</b>	LED, RGB <sup>1)</sup>
<b>Wave length</b>	470 nm, 525 nm, 625 nm
<b>Light emission</b>	Long side of housing
<b>Light spot size</b>	1.5 mm x 6.5 mm
<b>Light spot direction</b>	Vertical <sup>2)</sup>
<b>Receiving filters</b>	None
<b>Adjustment</b>	Cable, IO-Link Teach-in button
<b>Teach-in mode</b>	2-point teach-in static/dynamic + proximity to mark

<sup>1)</sup> Average service life: 100,000 h at T<sub>J</sub> = +25 °C.

<sup>2)</sup> In relation to long side of housing.

#### Mechanics/electronics

<b>Supply voltage</b>	12 V DC ... 24 V DC <sup>1)</sup>
-----------------------	-----------------------------------

<sup>1)</sup> Limit values: DC 12 V (-10 %) ... DC 24 V (+20 %). Operation in short-circuit protected network max. 8 A.

<sup>2)</sup> May not exceed or fall below U<sub>v</sub> tolerances.

<sup>3)</sup> Without load.

<sup>4)</sup> With light/dark ratio 1:1.

<sup>5)</sup> Signal transit time with resistive load.

<sup>6)</sup> Total current of all Outputs.

<b>Ripple</b>	$\leq 5 V_{pp}^{2)}$
<b>Current consumption</b>	$< 50 \text{ mA}^{3)}$
<b>Switching frequency</b>	15 kHz <sup>4)</sup>
<b>Response time</b>	32 $\mu\text{s}$ <sup>5)</sup>
<b>Jitter</b>	15 $\mu\text{s}$
<b>Switching output</b>	NPN
<b>Switching output (voltage)</b>	NPN: HIGH = approx. $V_S$ / LOW $\leq 2 \text{ V}$
<b>Switching mode</b>	Light/dark switching
<b>Output current <math>I_{max.}</math></b>	50 mA <sup>6)</sup>
<b>Retention time (ET)</b>	28 ms, non-volatile memory
<b>Time delay</b>	Switch-off delay, 520 ms (via IO-Link)
<b>Connection type</b>	Male connector M8, 4-pin
<b>Protection class</b>	III
<b>Circuit protection</b>	$U_V$ connections, reverse polarity protected Output Q short-circuit protected Interference pulse suppression
<b>Enclosure rating</b>	IP67
<b>Weight</b>	20 g
<b>Housing material</b>	Plastic, ABS
<b>Optics material</b>	Plastic, PMMA
<b>Indication</b>	LED indicator green: power on LED indicator, yellow: Status switching output Q

1) Limit values: DC 12 V (-10 %) ... DC 24 V (+20 %). Operation in short-circuit protected network max. 8 A.

2) May not exceed or fall below  $U_V$  tolerances.

3) Without load.

4) With light/dark ratio 1:1.

5) Signal transit time with resistive load.

6) Total current of all Outputs.

## Communication interface

<b>Communication Interface detail</b>	V1.1
Data transmission rate	38,4 kbit/s (COM2)
Cycle time	2.3 ms
VendorID	26
DeviceID HEX	800070
DeviceID DEC	8388720
<b>Process data length</b>	16 Bit
<b>Process data structure A</b>	Bit 0 ... 2 = Emission Color Bit 3 ... 12 = Measurement Value RGB Bit 13 ... 15 = empty
<b>Process data structure B</b>	Bit 0 = switching signal $Q_{L1}$ Bit 1 ... 10 = Measurement Value Emission Color Bit 11 ... 15 = empty
<b>Process data structure C</b>	Bit 0 = switching signal $Q_{L1}$ Bit 1 = Quality of Run Alarm Bit 2 = Teach successful Bit 3 = Teach busy

<b>Digital output</b>	Bit 4 ... 15 = empty
	Q <sub>1</sub> , Q <sub>2</sub>
Number	2

### Ambient data

<b>Ambient operating temperature</b>	-10 °C ... +55 °C
<b>Ambient storage temperature</b>	-20 °C ... +75 °C
<b>Shock load</b>	According to IEC 60068
<b>UL File No.</b>	NRKH.E348498 & NRKH7.E348498

### Classifications

<b>ECl@ss 5.0</b>	27270906
<b>ECl@ss 5.1.4</b>	27270906
<b>ECl@ss 6.0</b>	27270906
<b>ECl@ss 6.2</b>	27270906
<b>ECl@ss 7.0</b>	27270906
<b>ECl@ss 8.0</b>	27270906
<b>ECl@ss 8.1</b>	27270906
<b>ECl@ss 9.0</b>	27270906
<b>ECl@ss 10.0</b>	27270906
<b>ECl@ss 11.0</b>	27270906
<b>ETIM 5.0</b>	EC001820
<b>ETIM 6.0</b>	EC001820
<b>ETIM 7.0</b>	EC001820
<b>UNSPSC 16.0901</b>	39121528

### Connection/Pin assignment

<b>Connection type</b>	Male connector M8, 4-pin
<b>Pin assignment</b>	
BN 1	+ (L+)
WH 2	Q
BU 3	-(M)
BK 4	Q/C

**Dimensional drawing** (Dimensions in mm (inch))

KTM Prime

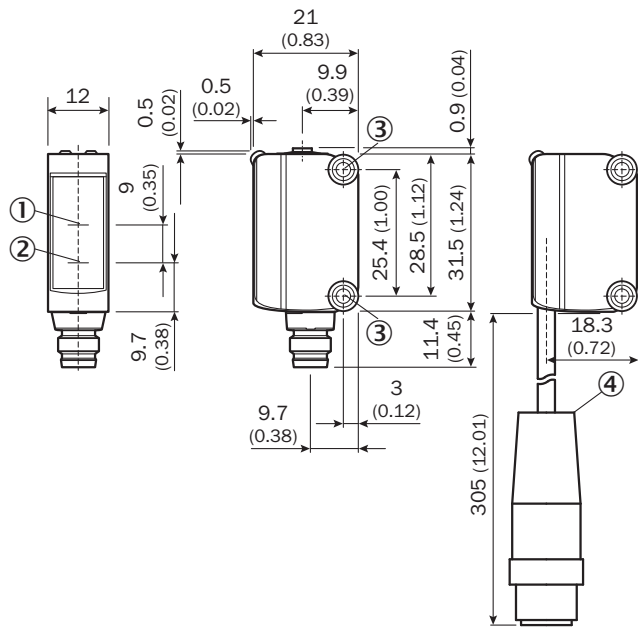

- ① Optical axis, receiver
- ② Optical axis, sender
- ③ M3 mounting hole
- ④ Cable with male connector M12 (only KTM-xxxx2x)

**Adjustments**

KTM Prime

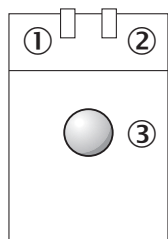

- ① Status indicator LED, yellow: Status switching output Q (dark switching)
- ② LED indicator green: Supply voltage active
- ③ Teach-in button

**Connection type**

See table: **Connection/Pin assignment**

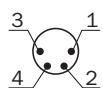

### Concept of operation

Setting the switching threshold (dynamic)

#### 1. Position background

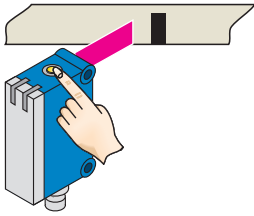

Press the teach-in button and keep it pressed. LED flashing slowly.

#### 2. Move at least the mark and background using the light spot.

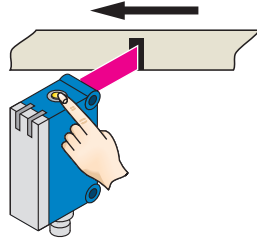

Keep the teach-in button > 3 < 30 s pressed.

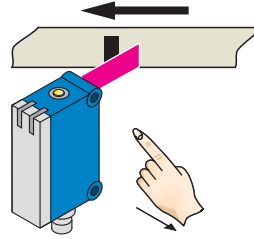

Release the teach-in button.

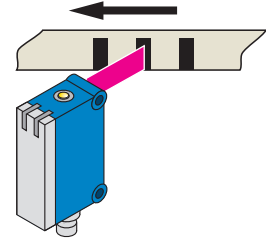

Yellow LED will illuminate, when emitted light is on the mark.

#### Example

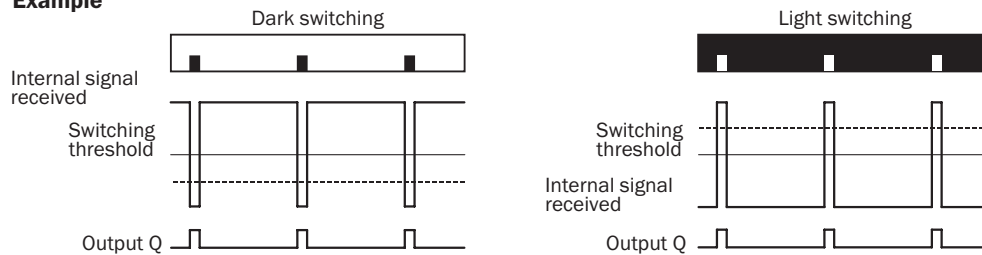

#### Switching characteristics

The optimum emitted light is selected automatically (at RGB variants).

Static teach-in: light/dark setting is defined using teach-in sequence.

Dynamic teach-in: switching output active on mark, if background is longer in the field of view during the teach-in.

The switching threshold is set in the center between the background and the mark.

If the button is pressed again within 10 s of the teach (> 20 ms < 10 s), the relative switching threshold is placed 75 % between mark (100 %) and background (0 %) (dotted line in Figure).

Teach-in can also be performed using an external control signal.

Keylock activation and deactivation: hold down teach-in button > 30 s.

Teach-in failure: yellow LED indicator and the transmitted light of the sensor flashing quickly.

For dynamic teach-in with ET signal (5 Hz) via switching output Q.

Setting the switching threshold (static)

1. Position mark

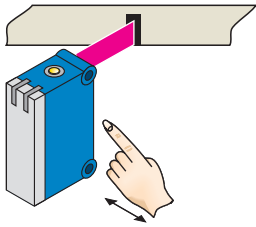

Press and hold teach-in button > 1 < 3 s.  
Yellow LED flashes slowly.

2. Position background

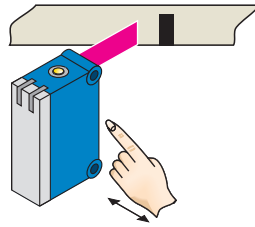

Press and hold teach-in button < 3 s.  
Yellow LED goes out.

Sensing distance



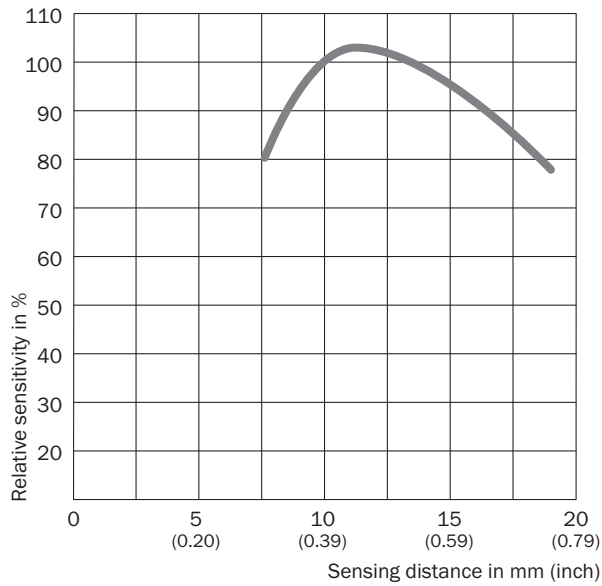

Sensing distance



Recommended accessories

Other models and accessories → [www.sick.com/KTM\\_Prime](http://www.sick.com/KTM_Prime)

	Brief description	Type	Part no.
Mounting brackets and plates			
	Mounting bracket for wall mounting, stainless steel, mounting hardware included	BEF-W100-A	5311520

	Brief description	Type	Part no.
Plug connectors and cables			
	Head A: female connector, M8, 4-pin, straight, A-coded Head B: Flying leads Cable: Sensor/actuator cable, PVC, unshielded, 5 m	YF8U14-050VA3XLEAX	2095889
	Head A: male connector, M8, 4-pin, straight Head B: - Cable: unshielded	STE-0804-G	6037323
SIG200			
		SIG200-0A0412200	1089794
		SIG200-0A0G12200	1102605



## SICK AT A GLANCE

SICK is one of the leading manufacturers of intelligent sensors and sensor solutions for industrial applications. A unique range of products and services creates the perfect basis for controlling processes securely and efficiently, protecting individuals from accidents and preventing damage to the environment.

We have extensive experience in a wide range of industries and understand their processes and requirements. With intelligent sensors, we can deliver exactly what our customers need. In application centers in Europe, Asia and North America, system solutions are tested and optimized in accordance with customer specifications. All this makes us a reliable supplier and development partner.

Comprehensive services complete our offering: SICK LifeTime Services provide support throughout the machine life cycle and ensure safety and productivity.

For us, that is “Sensor Intelligence.”

## WORLDWIDE PRESENCE:

Contacts and other locations –[www.sick.com](http://www.sick.com)