

Weller®

Fume Extraction Irons



Betriebsanleitung - Mode d'emploi - Istruzioni per l'uso - Operating Instructions

Legen Sie das Lötwerkzeug bei Nichtgebrauch immer in der Sicherheitsablage ab.

Beschreibung

Weller FE- LötKolben sind für den Betrieb mit dem Zero-Smog-System konstruiert und mit einem integrierten Absaugrohr ausgestattet, welches unangenehme und gesundheitsgefährdende Dämpfe dort absaugt, wo sie entstehen: direkt an der Lötspitze. Die Lötspitzen-temperatur wird dadurch nicht beeinflusst.

Inbetriebnahme

1. Beiliegenden Trichter für Halter gegen den Originaltrichter austauschen. Hierbei beachten, dass das Absaugrohr beim Ablegen in der oberen Position ist und die Ablagefeder nicht berührt.
2. Absaugrohr auf die Lötspitze justieren. In Lötposition sollte das Rohrende senkrecht über der Lötspitze sein.
3. LötKolben in Sicherheitsablage ablegen.
4. Elektronische Verbindungsleitung des FE- LötKolbens mit der Versorgungseinheit verbinden.

- ▲ FE 50 M an PU S.
- ▲ FE 50 und MLR 21 FE an alle elektronisch regelbaren Versorgungseinheiten.
- ▲ FE 75 an alle elektronisch regelbaren Versorgungseinheiten mit 80 W-Anschlussstechnik.
- ▲ FE 80 an alle elektronisch regelbaren Versorgungseinheiten mit 80 W-Anschlussstechnik.

5. Silikon-Absaugschlauch an den Zero-Smog oder an das Vakuum- Rohrsystem anschließen.

Wartung

Das Absaugrohr ist mit einem kleinen Biegeradius versehen. Dadurch wird das Rohr im Schaft des Kolbengriffes gehalten.

Sollte sich das Absaugrohr während des Betriebs lockern, kann es durch leichtes nachbiegen wieder fixiert werden.

Das Absaugrohr sollte einmal täglich mit der beiliegenden Bürste gereinigt werden.

Um Verbrennungen zu vermeiden, sollte dies in kaltem Zustand geschehen.

Bei starker Verschmutzung kann das Absaugrohr in einem abgeschlossenen Behälter in Reinigungsalkohol (Spiritus) gelegt werden bis sich die Flussmittelrückstände gelöst haben.

Warnung:

Bei der Verwendung von Reinigungsmittel sind die gesetzlichen Sicherheitsvorschriften für deren Handhabung einzuhalten. Das Reinigungsmittel muss als Sondermüll behandelt werden und nach geltenden örtlichen Bestimmungen entsorgt werden.

Um eine korrekte Funktion sicherzustellen, ist eine regelmäßige Reinigung des Absaugschlauches erforderlich. Hierzu auch den Schlauch abziehen und auskühlen lassen. Danach den Schlauch mit den Fingern kneten, bis sich die kondensierten Flußmittelrückstände lösen von der Turbine absaugt werden.

Sicherheitshinweise

- Den LötKolben stets in der Originalablage ablegen.
- Alle brennbaren Gegenstände aus der Nähe des heißen Lötwerkzeuges bringen.
- Geeignete Schutzbekleidung verwenden. Verbrennungsgefahr durch flüssiges Lötinn.
- Den heißen LötKolben nie unbeaufsichtigt lassen.
- Arbeiten Sie nicht an unter Spannung stehenden Teilen.

Die Betriebsanleitung der verwendeten Versorgungseinheit ist zu dieser Betriebsanleitung ergänzend gültig.

Die aktualisierten Betriebsanleitungen finden Sie unter www.weller-tools.com.



En cas de non utilisation de l'outil de soudage, toujours le poser dans la plaque reposeir de sécurité.

Description

Les fers à souder Weller FE sont conçus pour être utilisés avec le système Zero-Smog. Ils sont équipés d'un système d'aspiration des fumées de soudage intégré qui aspire les fumées désagréables et nocives à la source: directement au niveau de la panne. La température de la panne n'en est pas affectée.

Mise en service

1. Remplacer l'entonnoir joint sur le support à la place de l'entonnoir d'origine. Le tube d'aspiration doit se trouver au dessus et ne pas toucher le ressort quand on repose le fer sur son support.
2. Ajuster le tube d'aspiration sur la panne. En position de soudage, l'extrémité du tube doit être à la verticale de la panne.
3. Reposer le fer sur son support.
4. Relier le cordon de liaison électrique du fer à souder FE à l'unité d'alimentation.

- ▲ FE 50 M à PU S.
- ▲ FE 50 et MLR 21 FE à tous les blocs Temtronic.
- ▲ FE 75 à tous les blocs 80 W.
- ▲ FE 80 à tous les blocs 80 W.

5. Raccorder le tuyau d'aspiration en silicone au Zero-Smog ou au système à vide.

Entretien

Le tube d'aspiration est légèrement courbé son maintien dans la tige de la poignée du fer. Si le tube d'aspiration se détache pendant le fonctionnement, il peut à nouveau être fixé en le courbant légèrement.

Le tube d'aspiration doit être nettoyé quotidiennement avec la brosse jointe. Pour éviter toute brûlure, effectuer le nettoyage à froid. Si le tube d'aspiration est très sale, il peut être placé dans un récipient fermé contenant de l'alcool de nettoyage jusqu'à ce que les résidus de flux soient dissous.

Attention:

Lors de l'utilisation de produits de nettoyage, observer les consignes de sécurité légales en vigueur pour leur manipulation. Le produit de nettoyage entre dans la catégorie des déchets spéciaux et doit être éliminé conformément à la réglementation locale en vigueur.

Pour garantir le bon fonctionnement, il est également nécessaire de nettoyer régulièrement le tuyau d'aspiration. Pour ce faire, débrancher le tuyau et le laisser refroidir puis, le rouler entre les doigts pour que les résidus solides de flux se détachent et soient aspirés par la pompe.

Consignes de sécurité

- Déposer toujours le fer à souder dans le support d'origine.
- Eloigner tous les objets inflammables du fer à souder brûlant.
- Porter des vêtements de protection adéquats. Danger de brûlure par l'étain en fusion.
- Ne jamais laisser le fer à souder brûlant sans surveillance.
- Ne travaillez pas sur des pièces sous tension.

En plus du présent mode d'emploi, observer le mode d'emploi de l'unité d'alimentation utilisée.

Vous trouverez les manuels d'utilisation actualisés sur www.weller-tools.com.



In caso di non utilizzo, l'utensile di saldatura deve essere sempre appoggiato sul supporto di sicurezza.

Stili saldanti con dispositivo di aspirazione fumi

Gli stili saldanti Weller FE sono stati concepiti per essere utilizzati in abbinamento al sistema Zero-Smog. Essi presentano, integrato nell'impugnatura, un dispositivo di aspirazione che rimuove gli sgradevoli e nocivi fumi della saldatura direttamente dove si generano: la punta saldante, senza tuttavia influenzarne la temperatura.

Messa in esercizio

1. Sostituire l'imbuto precedentemente utilizzato con quello accluso. Assicurarsi che riponendo lo stilo, il tubetto di aspirazione sia sopra la punta e che non tocchi la molla di supporto.
2. Posizionare il tubetto di aspirazione sulla punta saldante. Durante la saldatura l'estremità del tubetto deve essere allineata verticalmente sopra la punta saldante.
3. Riporre lo stilo nel supporto di sicurezza.
4. Collegare e bloccare con uno scatto il connettore elettrico alla unità di controllo.

▲ FE 50 M alla PU S.

▲ FE 50 ed MLR 21 FE a tutte le unità di controllo Tmtronic.

▲ FE 75 a tutte le stazioni di controllo Temtronic con 80 Watt di potenza.

▲ FE 80 a tutte le stazioni di controllo Temtronic con 80 Watt di potenza.

5. Collegare il tubetto siliconico di aspirazione allo Zero-Smog o al sistema di condotte del vuoto.

Manutenzione

Il tubetto metallico di aspirazione è leggermente ricurvo per poterlo bloccare nel manico dello stilo. Se durante l'uso il tubo dovesse allentarsi, è sufficiente piegarlo leggermente per fissarlo all'impugnatura.

Pulire quotidianamente il tubetto metallico con l'apposito scovolino. Per evitare ustioni effettuare l'operazione con lo stilo freddo. Nel caso di tubetto molto sporco è consigliabile immergere lo stesso in un recipiente chiuso contenente alcool per uso igienico-sanitario ed attendere che i residui di flussante si siano sciolti.

Attenzione:

Rispettare le norme e le indicazioni legislative di sicurezza relative all'uso dei detergenti. Il detergente, dopo l'uso, è un residuo nocivo e deve essere smaltito come previsto dalla legge.

Per garantire un corretto funzionamento del sistema di aspirazione, è necessario pulire regolarmente anche il tubetto siliconico di aspirazione. Sfilare il tubo siliconico e lasciarlo raffreddare quindi polveizzare i vapori condensati di flussante stringendo il tubetto tra le dita fino a quando la turbina a vuoto li avrà aspirati.

Sicurezza

- Riporre lo stilo brasatore sempre nel suo supporto originale.
- Tenere l'utensile di brasatura lontano da qualsiasi oggetto infiammabile.
- Indossare idonei indumenti protettivi. Pericolo di incendio da stagno liquido.
- Non lasciare mai inosservato lo stilo brasatore caldo.
- Non lavorare su pezzi sotto tensione.

Oltre alle presenti istruzioni d'uso sono da rispettare anche le istruzioni d'uso dell'unità di alimentazione utilizzata.

Trovate le istruzioni per l'uso aggiornate su www.weller-tools.com.



Always place the soldering tool in the safety rest while not in use.

Description

Weller FE soldering irons are designed for use with the Zero-Smog system and are equipped with an integrated extraction tube to remove unpleasant and dangerous fumes directly where they occur: at the solder tip. The tip temperature is not effected.

Setting up

1. Replace the enclosed funnel against the original one. Make sure that the suction tube is in upper position and does not touch the spring holder when the iron is in rest position.
2. Adjust the extraction tube to the tip. The end of tube should be vertical above the tip when the iron is in soldering position.
3. Store soldering iron in safety holder.
4. Plug in and latch the electrical connector on the power unit.

▲ FE 50 M to PU S.

▲ FE 50 and MLR 21 FE to all Temtronic power supply units

▲ FE 75 to all power supply units with 80 W.

▲ FE 80 to all power supply units with 80 W.

5. connect the silicone suction hose to the Zero-Smog or vaccum pipe system.

Maintenance

The extraction tube has a small bending radius to hold the tube in the shaft of the soldering iron handle. If the extraction tube should become loose during use, it can be tightened by bending slightly.

The extraction tube should be cleaned once daily with the special brush. In order to avoid burns, the tube should be cleaned only after cooling. If the tube is extremely dirty, it can be placed in a closed container of cleaning alcohol (Spirit) until the fluxing media residues and loosened.

Warning:

When using cleaning agents, legal safety regulations regarding their use must be observed. The cleaning agent must be treated as hazardous waste and must be disposed of according to current local guidelines.

In order to ensure correct function, the extraction hose should also be cleaned regularly. The hose must first be unplugged and allowed to cool. Knead the hose between the fingers until the condensed fluxing media residues are loosened and are removed by the turbine.

Safety Informations

- Always place the soldering iron in the original holder.
- Remove all inflammable objects from the proximity of the hot soldering tool.
- Use suitable protective clothing. Risk of burns from liquid solder.
- Never leave the hot soldering iron unsupervised.
- Never work on voltage-carrying parts.

The instructions for the use of the supply unit are valid in addition of these here.

See the updated operating instructions at www.weller-tools.com.



FE 50 M

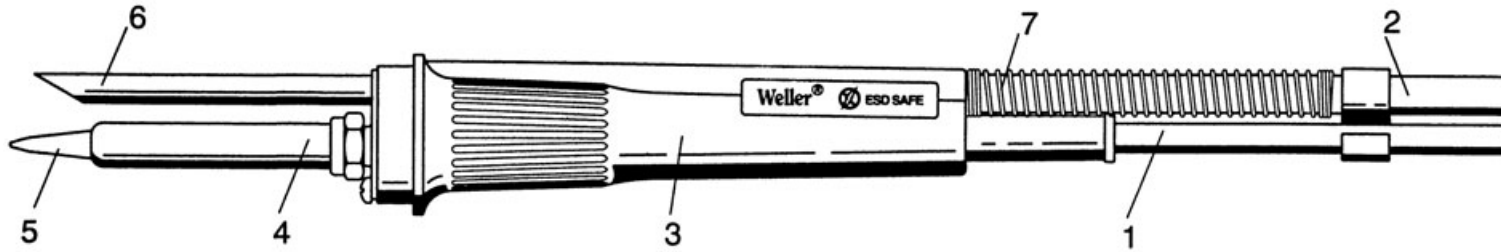

4D9R349

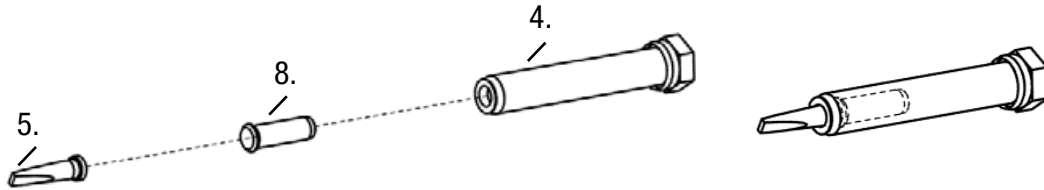

1. Kabel
2. Absaugschlauch
3. Griff
4. Spitzenhülse
5. PT- Longlife- Spitze
6. Absaugrohr
7. Biegeschutzfeder
8. PT- ET Adapter

1. Cordon
2. Tuyau d'aspiration
3. Manche
4. Douille pointue
5. Panne PT
6. Tube d'aspiration
7. Vis de serrage
8. PT-ET Adaptateur

1. Cordone di alimentazione
2. Tubetto silicnico di aspirazione
3. Impugnatura
4. Fermapunta
5. Punta long- life serie PT
6. Tubetto metallico di aspirazione
7. Vite di fissaggio
8. PT-ET Adattatore

1. Cord
2. Suction hose
3. Handle
4. Barrel
5. PT- Longlife- Tip
6. Suction tube
7. Strain relief spring
8. PT-ET Adapter

FE 50 M

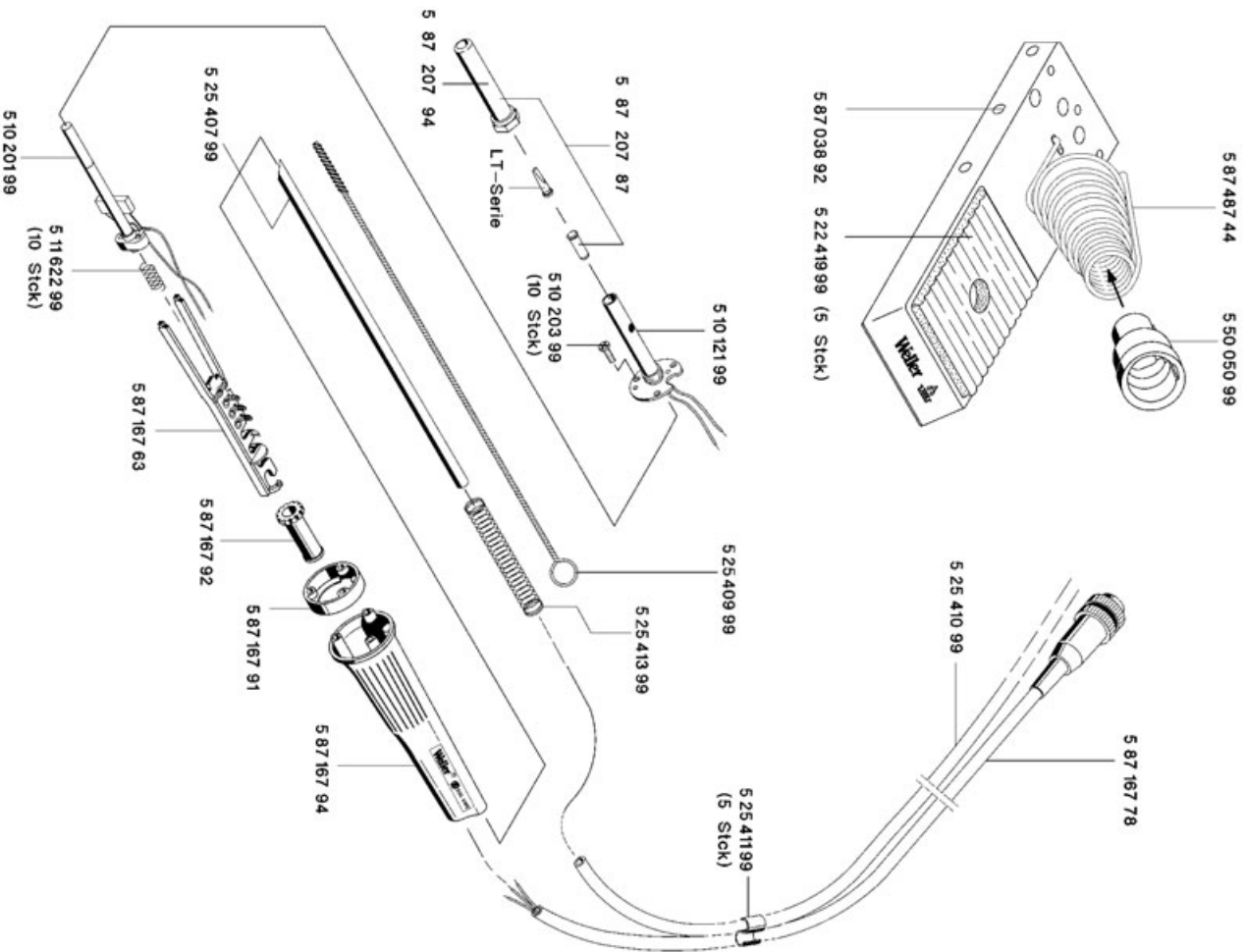

402R356/4

402R356/4

FE 50

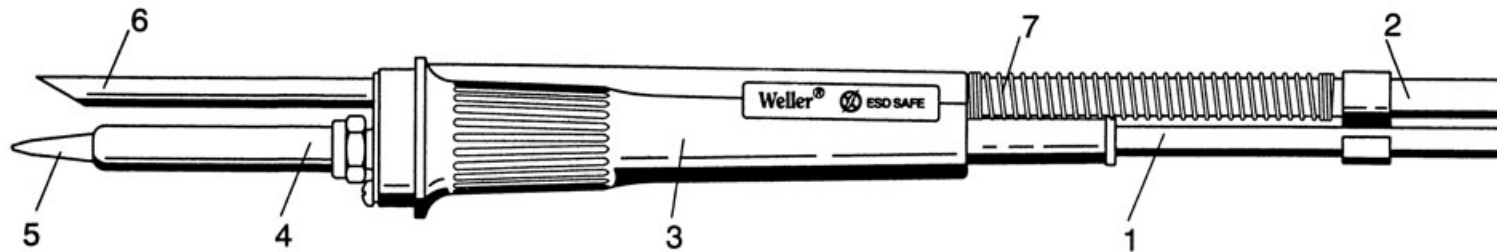

4D9R349

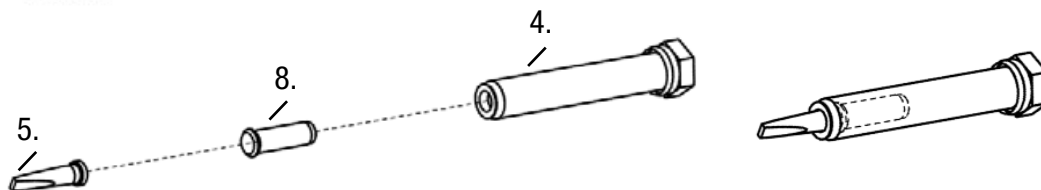

1. Kabel
2. Absaugschlauch
3. Griff
4. Spitzenhülse
5. ET- Longlife- Spitze
6. Absaugrohr
7. Biegeschutzfeder
8. PT- ET Adapter

1. Cordon
2. Tuyau d'aspiration
3. Manche
4. Douille pointue
5. Panne ET
6. Tube d'aspiration
7. Vis de serrage
8. PT-ET Adaptateur

1. Cordone di alimentazione
2. Tubetto siliconico di aspirazione
3. Impugnatura
4. Fermapunta
5. Punta long- life serie ET
6. Tubetto metallico di aspirazione
7. Vite di fissaggio
8. PT-ET Adattatore

1. Cord
2. Suction hose
3. Handle
4. Barrel
5. ET- Longlife- Tip
6. Suction tube
7. Strain relief spring
8. PT-ET Adapter

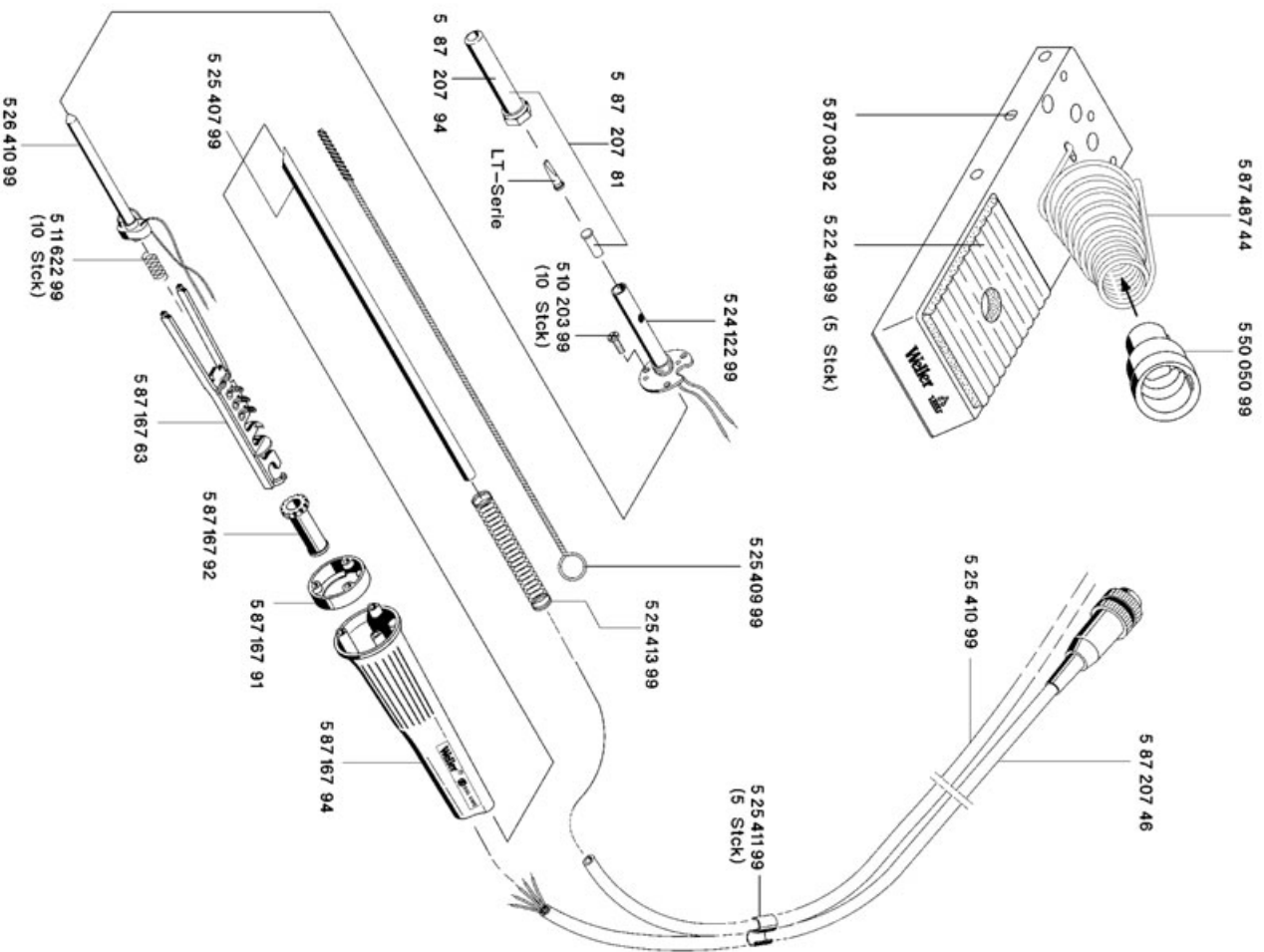

A02R35/6

A02R35/6

FE 75

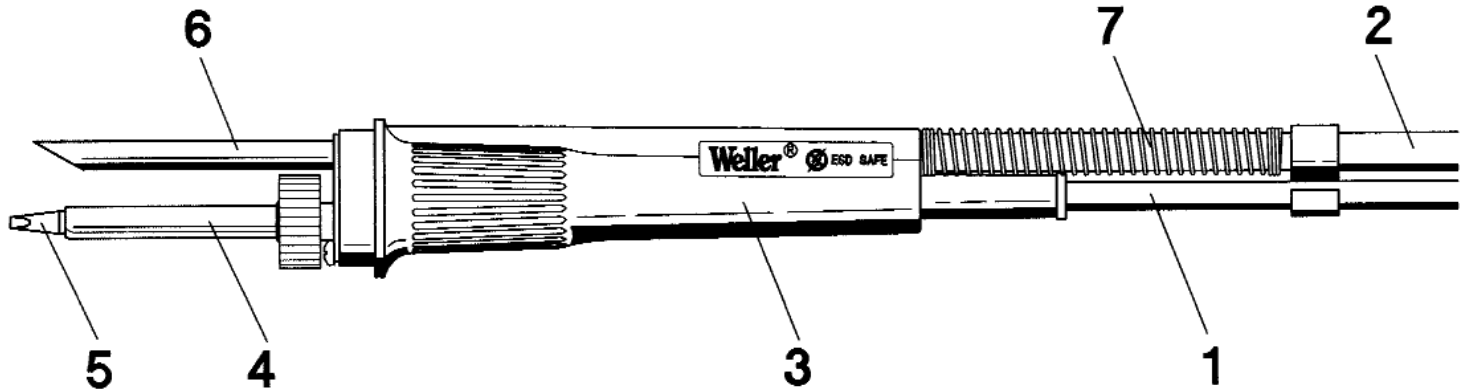

4D9R559/1

1. Kabel
2. Absaugschlauch
3. Griff
4. Spitzenhülse
5. LT- Longlife- Spitze
6. Absaugrohr
7. Biegeschutzfeder

1. Cordon
2. Tuyau d'aspiration
3. Manche
4. Douille pointue
5. Panne LT
6. Tube d'aspiration
7. Vis de serrage

1. Cordone di alimentazione
2. Tubetto siliconico di aspirazione
3. Impugnatura
4. Fermapunta
5. Punta long- life serie LT
6. Tubetto metallico di aspirazione
7. Vite di fissaggio

1. Cord
2. Suction hose
3. Handle
4. Barrel
5. LT- Longlife- Tip
6. Suction tube
7. Strain relief spring

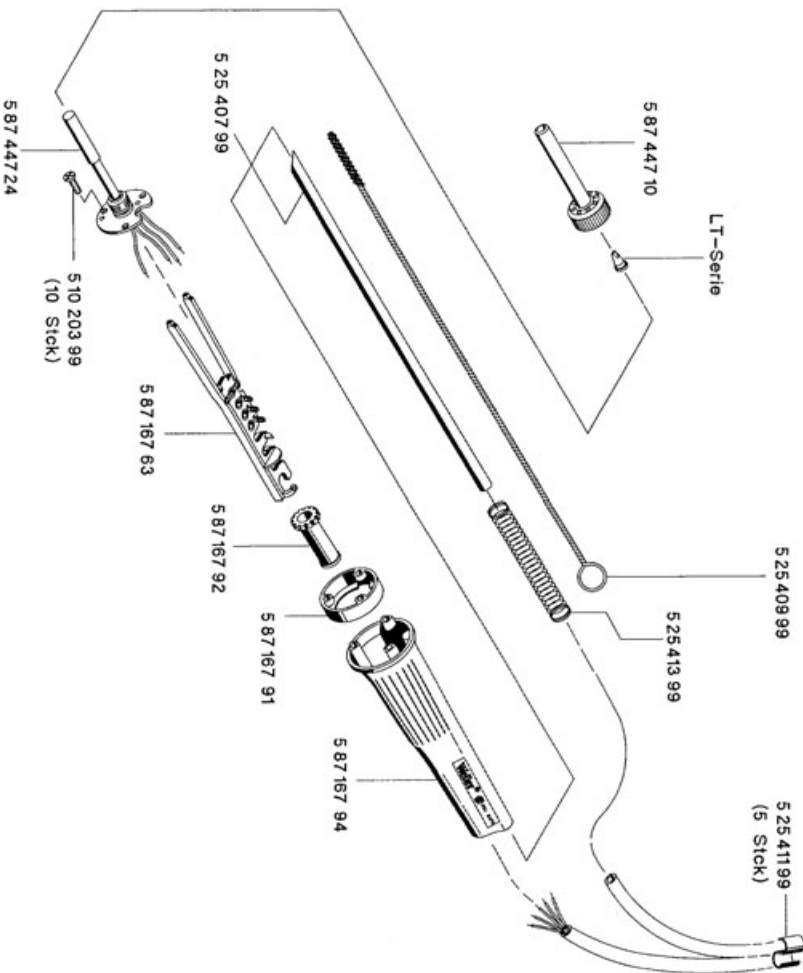
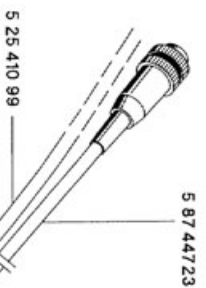
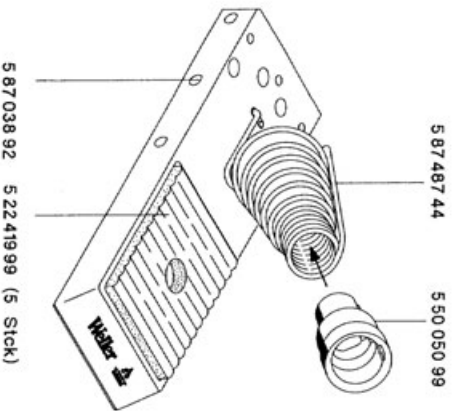

Adapter und Spitzen für FE 50, FE 50M und FE 75

Adapter and Tips for FE 50, FE 50M and FE 75

Beschreibung / Modell Description / Model	Breite Width	Bestell-Nr. Order-No.
--	-----------------	--------------------------



Barrel for MT-LT Adapter		5 87 207 95
Barrel for ET-PT / LT Adapter		5 87 207 94
Barrel for ET, PT Tip		5 10 311 99

ET-LT Adapter with barrel		5 87 207 81
---------------------------	---	-------------



PT-LT Adapter with barrel		
PT5-LT		5 87 207 85
PT6-LT		5 87 207 86
PT7-LT		5 87 207 87
PT8-LT		5 87 207 88
PT9-LT		5 87 207 89



MT-LT Adapter with barrel		5 44 121 99
---------------------------	---	-------------

Beschreibung / Modell Description / Model	Breite Width	Bestell-Nr. Order-No.
--	-----------------	--------------------------





Meißelform / Chisel			
LT H	0,8 mm		5 44 412 00
LT A	1,6 mm		5 44 403 00
LT B	2,4 mm		5 44 405 00
LT C	3,2 mm		5 44 407 00
LT D	4,6 mm		5 44 409 00
ET E	5,6 mm		4ETE

Meißelform lang / Chisel long			
LT K	1,2 mm		5 44 413 00
LT L	2,0 mm		5 44 414 00
LT M	3,2 mm		5 44 415 00

Meißelform geb. 30° / Chisel bent 30°			
LT HX	0,8 mm		5 44 420 99
LT ALX	1,6 mm		5 44 443 00
LT BX	2,4 mm		5 44 442 00

Rundform abgeschrägt 45° lang Chisel sloped 45° long			
LT CC45	3,2 mm		5 44 445 00
LT DD45	4,0 mm		5 44 478 00
LT DDLL	4,6 mm		5 44 486 00
Rundform abgeschrägt 60° lang Chisel sloped 60° long			
LT AA60	1,6 mm		5 44 487 00
LT BB60	2,4 mm		5 44 444 00

Spitzen für FE 50, FE 50M und FE75
Tips for FE 50, FE 50M and FE 75

Beschreibung / Modell Description / Model	Breite Width		Bestell-Nr. Order-No.
Konisch lang / Conical long			
LT 1L	Ø 0,2 mm		5 44 423 00
LT S	Ø 0,4 mm		5 44 406 00
LT O	Ø 0,8 mm		5 44 481 00
LT T	Ø 0,6 mm		5 44 482 00
Konisch lang / Conical long			
LT 1LX	Ø 0,25 mm		5 44 424 00
Lotdepotspitze 45° / Gull wing 45°			
LT GW	Ø 2,3 mm		5 44 410 00
	Ø 3,5 mm		5 44 511 99
Messerspitze / Knife tip			
LT KN	6,2 mm		5 44 479 00
Rundform / Round tip			
LT 1	Ø 0,25 mm		5 44 401 00
LT AS	Ø 1,6 mm		5 44 404 00
LT BS	Ø 2,4 mm		5 44 499 00
LT CS	Ø 3,2 mm		5 44 411 00

Beschreibung / Modell Description / Model	Breite Width		Bestell-Nr. Order-No.
Rundform schlank gebogen 30°			
Chisel slim bent 30° LT 1SLX	Ø 2,0 mm		5 44 426 99

FE 80

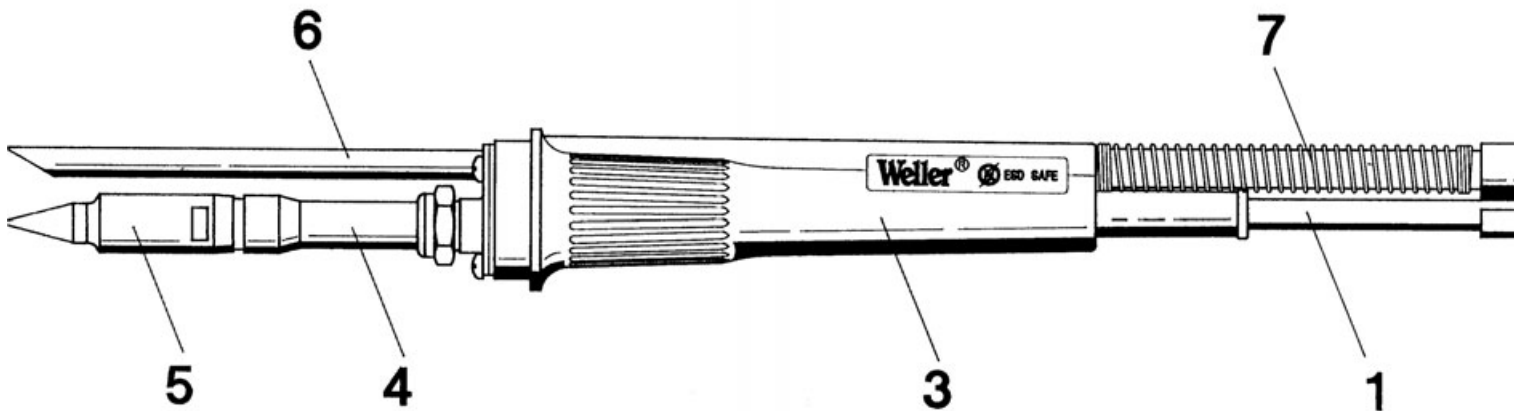

4D9R479

- 1. Kabel
- 2. Absaug Schlauch
- 3. Griff
- 4. Spitzengehäuse
- 5. HT- Longlife- Spitze
- 6. Absaugrohr
- 7. Biegeschutzfeder





- 1. Cordon
- 2. Tuyau d'aspiration
- 3. Manche
- 4. Forreau
- 5. Panne HT
- 6. Tube d'aspiration
- 7. Vis de serrage

- 1. Cordone di alimentazione
- 2. Tubetto siliconico di aspirazione
- 3. Impugnatura
- 4. Tubetto fermapunta
- 5. Punta long- life serie HT
- 6. Tubetto metallico di aspirazione
- 7. Vite di fissaggio

- 1. Cord
- 2. Suction hose
- 3. Handle
- 4. Barrel
- 5. HT- Longlife- Tip
- 6. Suction tube
- 7. Strain relief spring

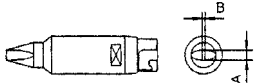
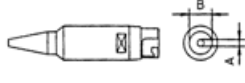
HT Spitzen für FE 80

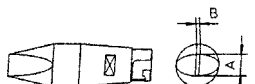
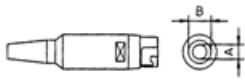
HT Tips for FE 80

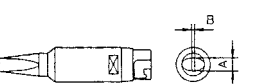
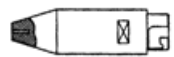
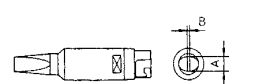
Modell Model	Beschreibung Description	Bestell-Nr. Order-No.	Modell Model	Beschreibung Description	Bestell-Nr. Order-No.
HT 1	 Meißelform 3,2 mm Chisel tip 3,2 mm	5 44 260 99	HT BS	 Rundform 2,4 mm Round tip 2,4 mm	5 44 264 99
HT 2	 Meißelform 5,2 mm Chisel tip 5,2 mm	5 44 261 99	HT CS	 Rundform 3,2 mm Round tip 3,2 mm	5 44 2665 99
HT 3	 Meißelform 7,0 mm Chisel tip 7,0 mm	5 44 262 99	HT DS	 Rundform 5,0 mm Round tip 5,0 mm	5 44 266 99
HT C	 Flachform 3,2 mm Chisel tip, 3,2 mm	5 44 267 99		 HT Einschraubspitze mit M8 Außengewinde HT Screw in tip with outside thread M8	5 44 270 99
HT D	 Flachform 4,6 mm Chisel tip 4,6 mm	5 44 268 99		 Messspitze Calibration tip	5 44 263 99
HT E	 Flachform 5,6 mm Round tip 3,2	5 44 269 99			

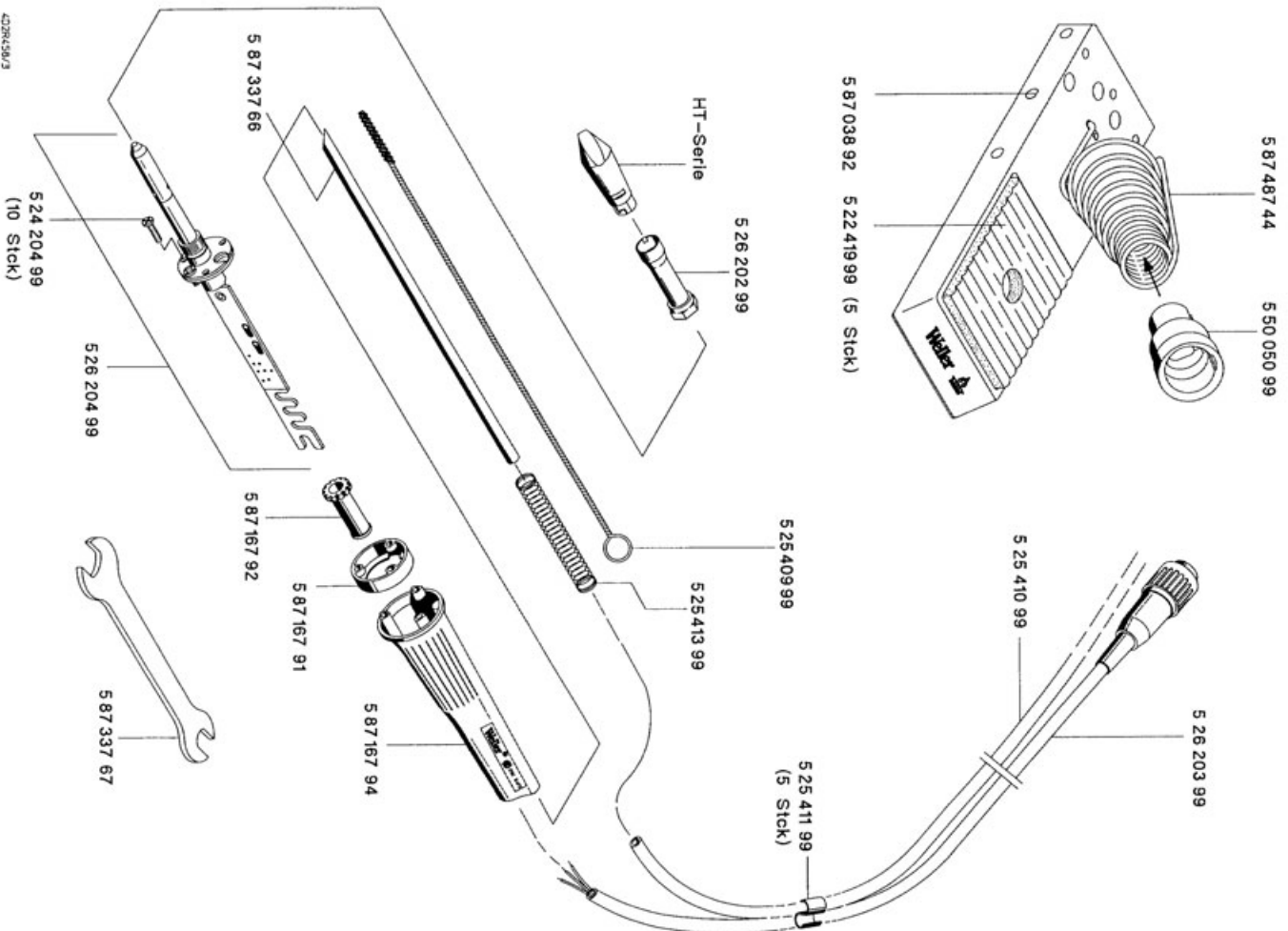

GERMANY**Weller Tools GmbH**

Carl-Benz-Str. 2
74354 Besigheim
Phone: +49 (0) 7143 580-0
Fax: +49 (0) 7143 580-108

GREAT BRITAIN**Apex Tool Group
(UK Operations) Ltd**

4th Floor Pennine House
Washington, Tyne & Wear
NE37 1LY
Phone: +44 (0) 191 419 7700
Fax: +44 (0) 191 417 9421

FRANCE**Apex Tool Group S.N.C.**

25 avenue Maurice Chevalier BP 46
77832 Ozoir-la-Ferrière, Cedex
Phone: +33 (0) 1.64.43.22.00
Fax: +33 (0) 1.64.43.21.62

ITALY**Apex Tool S.r.l.**

Viale Europa 80
20090 Cusago (MI)
Phone: +39 (02) 9033101
Fax: +39 (02) 90394231

SWITZERLAND**Apex Tool Switzerland Sàrl**

Rue de la Roselière 12
1400 Yverdon-les-Bains
Phone: +41 (0) 24 426 12 06
Fax: +41 (0) 24 425 09 77

AUSTRALIA**Apex Tools - Australia**

P.O. Box 366
519 Nurigong Street
Albury, N. S. W. 2640
Phone: +61 (2) 6058-0300
Fax: +61 (2) 6021-7403

CANADA**Apex Tools - Canada**

5925 McLaughlin Rd.
Mississauga
Ontario L5R 1B8
Phone: +1 (905) 501-4785
Fax: +1 (905) 387-2640

CHINA**Apex Tool Group**

A-8 Building, No. 38 Dongsheng Road
Heqing Industrial Park, Pudong
Shanghai 201201
Phone: +86 (21) 60880288
Fax: +86 (21) 60880289

USA**Apex Tool Group, LLC**

14600 York Rd. Suite A
Sparks, MD 21152
Phone: +1 (800) 688-8949
Fax: +1 (800) 234-0472

T005 55 275 10 / 09.2013

T005 55 275 09 / 10.2012

www.weller-tools.com**Weller®**