

Quick Reference Guide

.050 CENTERLINE MICRO-MATCH VALUE-LINE

TE Connectivity added a new series of Micro-MaTch connectors to the well-established Micro-MaTch family: “Micro-MaTch Value-line”. This new series features a more economical design and meets the needs of less demanding applications in the Industrial, Consumer and Datacom industry. The Micro-MaTch Value-line is built around the existing high quality Micro-MaTch connector system and has been developed to suit environments where a broad temperature range, many mating cycles and vibration resistance are less relevant. On a pitch of 1.27 mm, Micro-Match Value-line offers a variety of wire-to-board inter-connections.

Features and Benefits

- Cost effective Wire to Board system with tin plated contact design
- Miniature connector system to save space on the printed circuit board
- All connectors supplied on Tape & Reel and suitable for automatic placing and termination
- Highly reliable gas tight and corrosion free connections between wire and insulation displacement contacts
- Full range of application tooling from hand tool to fully automated equipment
- Cable connectors accepting all standard ribbon cable

Product Applications

- Home automation and alarm equipment
- Mobile GPS devices
- Lighting
- Air- and climate control units
- CCTV
- Building Surface Control
- Set Top Boxes, Audio- & Video equipment
- Electronic voting machines
- Pay terminals

PRODUCT/APPLICATION SPECIFICATION

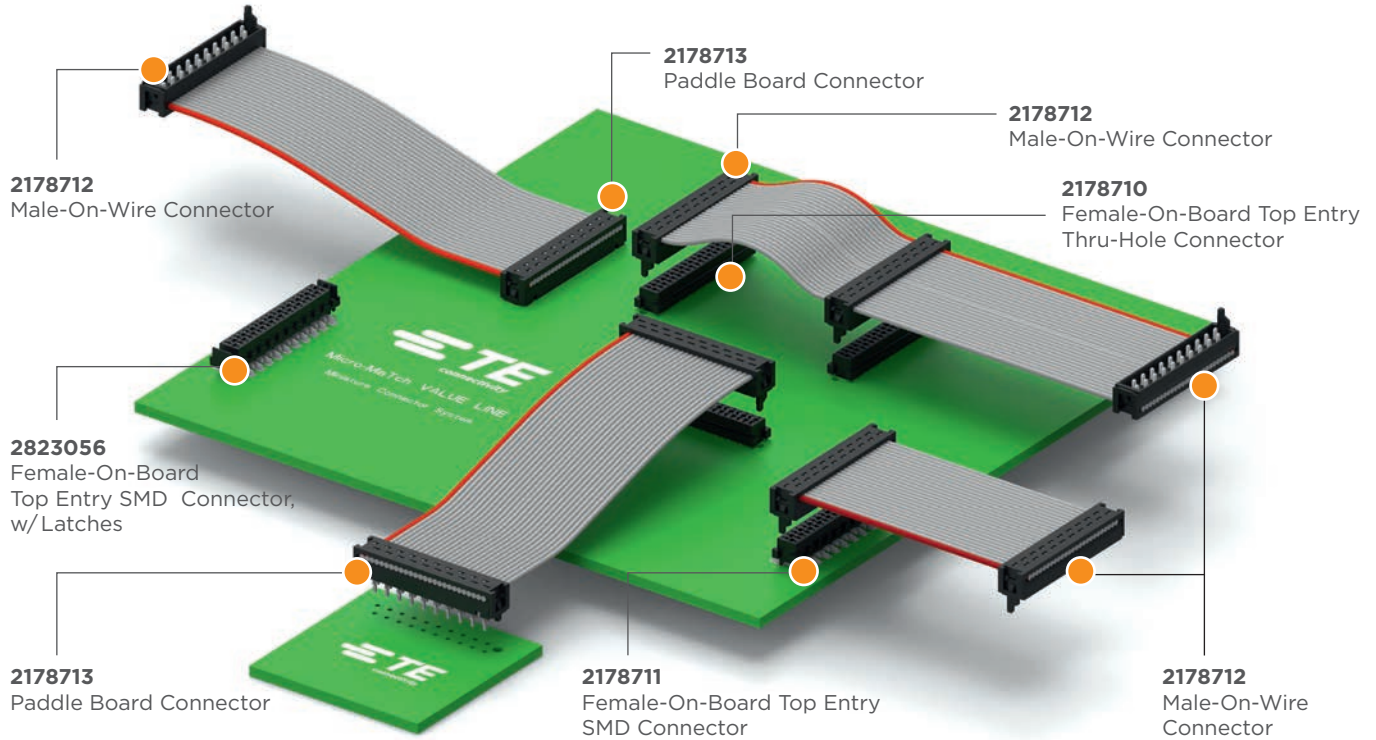

APPLICATION TOOLING

Hand Tools		
734155-1	734024-1	654061-1
Pistol grip	Adapter set	Flat Cable cutting tool
Bench Tools		
733280-3	733278-2	1-547008-7
Termination Die Set	Sub-assy toolset (4-20p)	Lever press incl. toolset (4-24p)
Semi-Automatic Tools		
677412-7	519708-1	438685-1
Semi Automatic, Base Press	Toolset for 2178712	Toolset for 2178713

Sample Box
with various
connectors:
1377074-2
(available on
order at TE)

Promotion Kit:
2288485-1

STANDARD CABLE ASSEMBLIES

pos	Partnumber*		Partnumber*	
4	2205103	Side A and B Male-on-Wire 2178712	2205112	Side A Male-on-Wire 2178712
6	2205104		2205113	
8	2205105		2205114	Side B Other side Paddle Board 2178713
10	2205106		2205115	
12	2205107		2205116	
14	2205108		2205117	
16	2205109		2205118	
18	2205110		2205119	
20	2205111		2205120	

* -1 L=75 mm; -2 L=150 mm; -3 L=200 mm

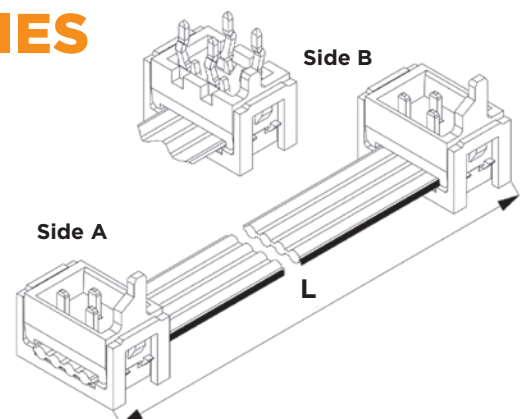

MICRO-MATCH VALUE-LINE PRODUCT PORTFOLIO

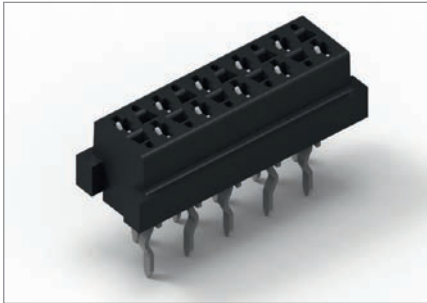

2178710
Female-On-Board
True-Hole Top Entry
Mates with 2178712

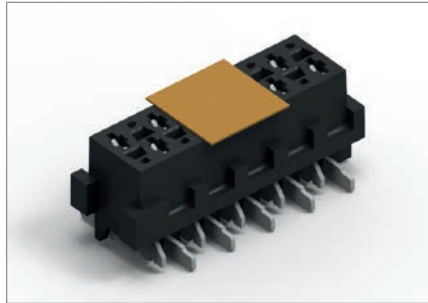

2178711
Female-On-Board
SMD Top Entry with tape
Mates with 2178712

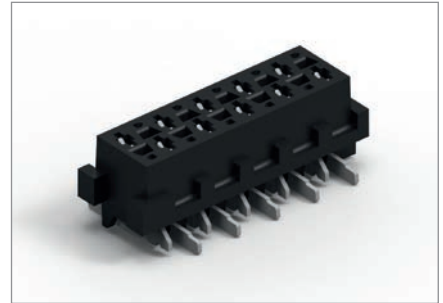

2178711
Female-On-Board
SMD Top Entry without tape
Mates with 2178712

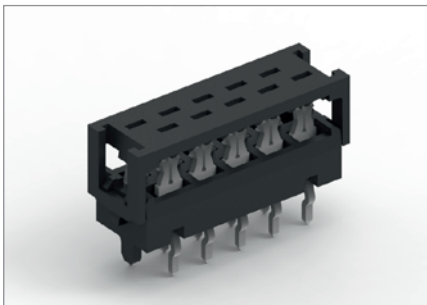

2178713
Paddle Board
Directly on PCB



2178712
Male-On-Wire
Mates with Female-On-Board

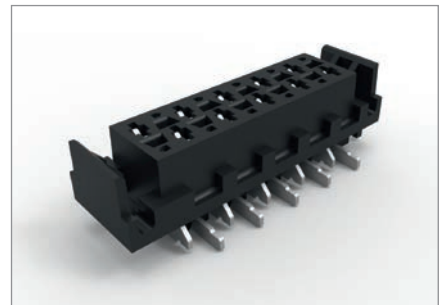

2823056
Female-On-Board w and w/o tape
SMD Top Entry w/latches
Mates with 2178712

Female On Board Connector – True Hole: Top Entry										
Position Size		4	6	8	10	12	14	16	18	20
Base Number	2178710	-4	-6	-8	-10	-12	-14	-16	-18	-20
Pack Size	Reel	2500	2500	2500	2500	2500	2500	2500	2500	2500

Female On Board Connector – Surface Mount: Top Entry										
Position Size		4	6	8	10	12	14	16	18	20
Base Number	2178711	-4	-6	-8	-10	-12	-14	-16	-18	-20
	With kapton P&P tape	-74	-76	-78	-80	-82	-84	-86	-88	-90
Base Number	2823056 *	-4	-6	-8	-10	-12	-14	-16	-18	-20
	With kapton P&P tape	-74	-76	-78	-80	-82	-84	-86	-88	-90
Pack Size	Reel	900	900	900	900	900	900	900	900	900

Male On Wire Connector										
Position Size		4	6	8	10	12	14	16	18	20
Base Number	2178712	-4	-6	-8	-10	-12	-14	-16	-18	-20
Pack Size	Reel	2500	2500	2500	2500	2500	2500	2500	2500	2500

Paddle Board Connector										
Position Size		4	6	8	10	12	14	16	18	20
Base Number	2178713	-4	-6	-8	-10	-12	-14	-16	-18	-20
Pack Size	Reel	2500	2500	2500	2500	2500	2500	2500	2500	2500

* available per 2015

FREQUENTLY ASKED QUESTIONS

Can we make Micro-MaTch Value-line connectors with contacts in Gold plating?

No. The Micro-MaTch contact system is designed to deliver a high normal-force as required for tinplated contact interconnections. This pressure is too high for gold plated interconnections, where much lower normal-forces are required.

We have noticed that the kinks of the Micro-MaTch Value-line thru-hole solder contacts on Top Entry Connectors, start with random direction. Is this technically OK?

Yes, this is OK and does not affect contact retention. For those connectors the kink direction in each row can start random, but sequential contacts within each row have kinks pointing in opposite directions.

Which flat ribbon cable is suitable for Micro-MaTch Value-line Male-on-Wire and Paddle-Board connectors and why?

The new design of the cable connectors within TE's Micro-MaTch Value-line will perfectly accept most Flat Ribbon Cable with 'oval' conductor design. The cable insulation's oval shape at each position and the flat transition between the positions, both exactly match with corresponding shape in the cover. This enables accurate pre-positioning of the conductors regarding to the IDC-slots during the termination process.

It is also important that the conductor's pitch is within tolerance and that they are symmetrically positioned in the insulation shape.

Are Micro-MaTch Value-line Male-on-Wire and Paddle-Board connectors also suitable for discrete wire termination?

No. For discrete wires, Micro-MaTch connectors offer the Crimp-On Snap-In (COSI) connectors in 2 wire ranges. Only available in the standard (Industrial) version.

Is there retention force performance available for the female connector version with locking latches?

No. The plastic latches were not designed to retain the connectors but to produce an audible click when the connectors are fully mated.

What exactly are the main differences between the Value-line and the actual (Industrial) Micro-MaTch version?

The actual Micro-MaTch version has a higher operating temperature, more mating cycles, and more vibration resistance. The Value-line is perfect for applications that are not exposed to heavy vibration, operate within a standard temperature range between -30C and +80C and are less prone to frequent mating cycles. For more information please contact your local TE Connectivity Sales representative.

Let's connect

We make it easy to connect with our experts and are ready to provide all the support you need. Just call your local support number or visit www.te.com/industrial to chat with a Product Information Specialist.

Technical Support

te.com/support-center

For more Information

te.com/products/micromatch

te.com

© 2014 Tyco Electronics Corporation, a TE Connectivity Ltd. Company. All Rights Reserved. 1-1773840-5 IND WR 11/2014

MICRO-MATCH, TE Connectivity and the TE connectivity (logo) are trademarks of the TE Connectivity Ltd. family of companies. Other logos, product and Company names mentioned herein may be trademarks of their respective owners. While TE has made every reasonable effort to ensure the accuracy of the information in this brochure, TE does not guarantee that it is error-free, nor does TE make any other representation, warranty or guarantee that the information is accurate, correct, reliable or current. TE reserves the right to make any adjustments to the information contained herein at any time without notice. TE expressly disclaims all implied warranties regarding the information contained herein, including, but not limited to, any implied warranties of merchantability or fitness for a particular purpose. The dimensions in this brochure are for reference purposes only and are subject to change without notice. Specifications are subject to change without notice. Consult TE for the latest dimensions and design specifications.