

PRODUCT NO.
10067847-0XXXXLF

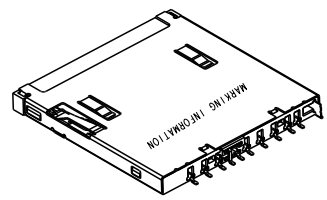

rev	ecn no	dr	date
A	DG08-0034	JC	02-04-08
B	DG08-0190	BL	09-03-08
C	DG08-0289	BL	10-29-08
D	DG09-0050	BL	02-25-09
E	DG09-0158	BL	05-18-09
F	DG09-0258	BL	10-19-09
G	ELX-DG-012660-1	AL	2012-08-28

spec ref	RELEASED	dr	Bill Lin	2008/09/28	projection	MM	size	A4	scale	1.000	
tolerance std	TOLERANCES UNLESS OTHERWISE SPECIFIED	eng	Andy Lu	2012/08/28			ecn no	ELX-DG-012660-1			
ASME Y14.5		chr	-					rel level	Released		
surface	<input checked="" type="checkbox"/> linear	0.X	±0.30		title	ASSEMBLY	dwg no	10067847			rev
		0.XX	±0.20								
		0.XXX	±0.10								
	angular	0°	±2°	www.fci.com	cat. no.	10067847	Product - Customer Drw			sheet 1 of 3	

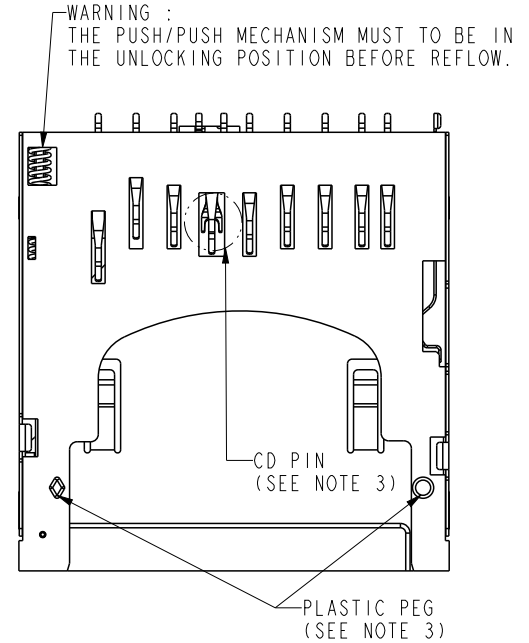
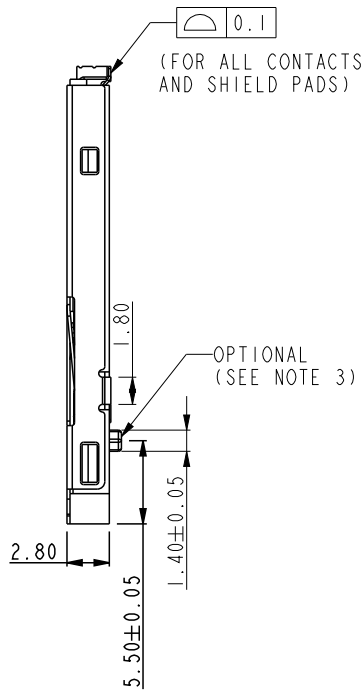
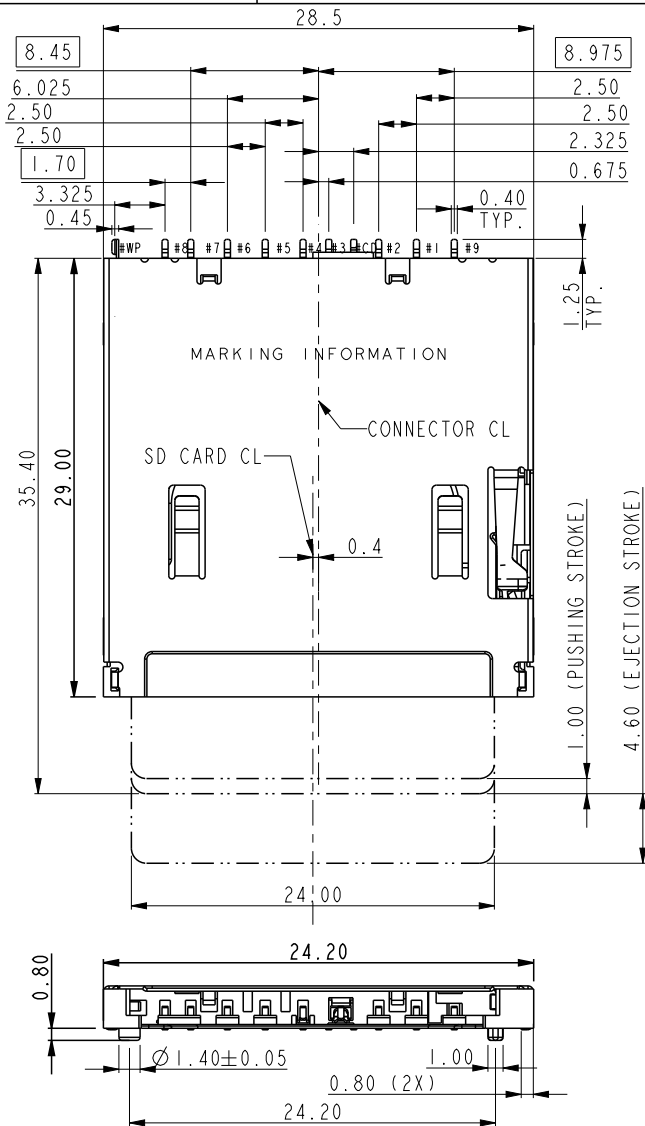

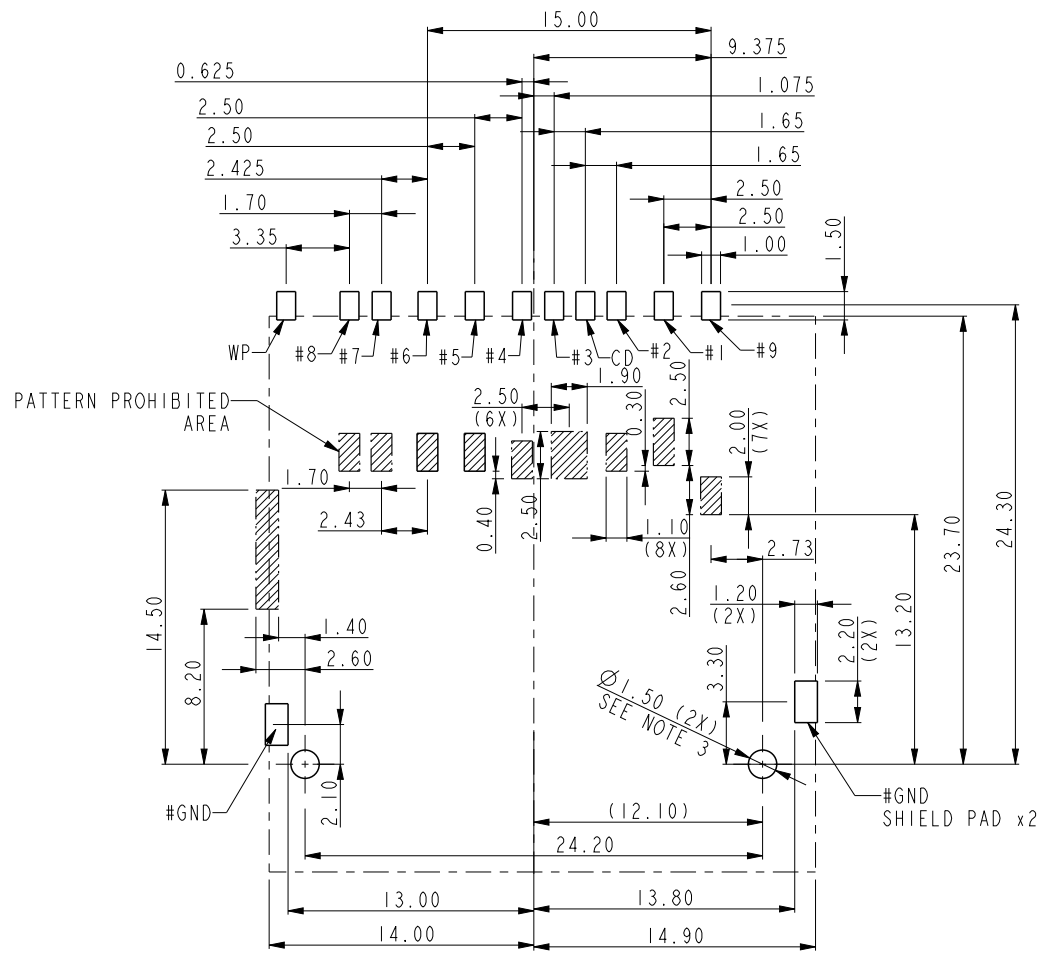

Copyright FCI.

A
B
C
D

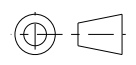

RECOMMENDED PCB LAYOUT
(FOR 10067847-0XXXLF)

dr	Bill Lin	2008/09/28	projection 	size A4	scale 1.000	
eng	Andy Lu	2012/08/28				
chr	-	-				
appr	Pei-Ming Zheng	2012/09/05	product family	SD	rel level	Released
			title ASSEMBLY SD CARD READER	dwg no 10067847	rev G	
www.fci.com		cat. no. 10067847	Product - Customer Drw		sheet 2 of 3	

NOTES:

- 1. MATERIAL
HOUSING : HIGH TEMPERATURE THERMOPLASTIC RESIN.
CONTACT : COPPER ALLOY
SHIELD : STAINLESS.
- 2 PLATING:
CONTACT : 50u" NICKEL UNDERPLATED ALL OVER.
100u" MATTE TIN ON SOLDER TAIL AREA.
GOLD PLATED ON CONTACT AREA (SEE CONTACT PLATING IN NOTE 3).

3. PART NUMBER DESCRIPTION:

10067847-X X X X X



PIN ASSIGNMENT

NO.	DESCRIPTION
#1	CD/DAT3
#2	CMD
#3	VSS
#4	VDD
#5	CLK
#6	VSS
#7	DAT0
#8	DAT1
#9	DAT2
#CD	CARD DETECTION
#WP	WRITE PROTECT
#GND	GROUND

4 MARKING INFORMATION

PXXXXXXXXXX

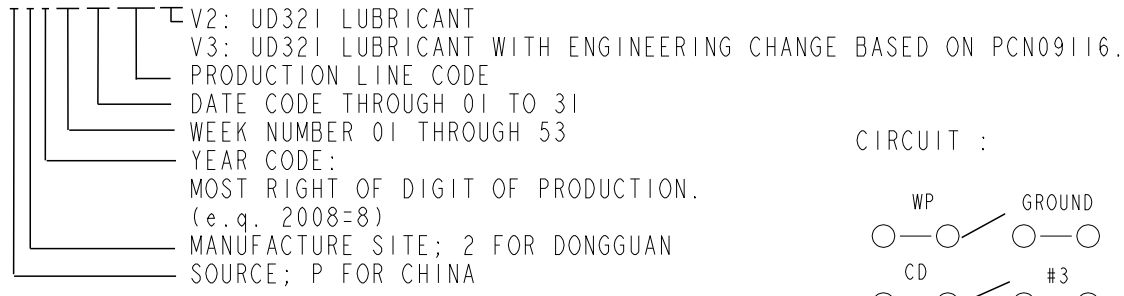

CIRCUIT :

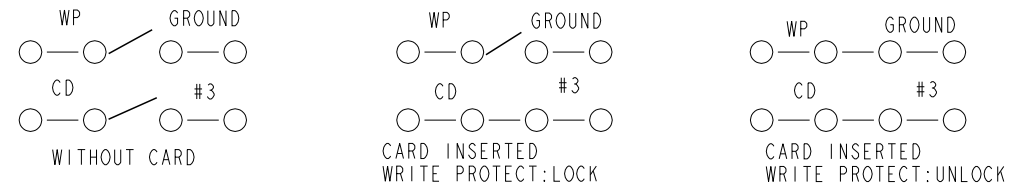

Copyright FCI.

dr	Bill Lin	2008/09/28	projection 	MM 	size	A4	scale	1.000
eng	Andy Lu	2012/08/28			ecn no	ELX-DG-012660-1		
chr	-	-			rel level	Released		
appr	Pei-Ming Zheng	2012/09/05	product family		SD		rev	
		title			ASSEMBLY		dwg no	
www.fci.com		cat. no.			10067847		10067847	
		Product - Customer Drw			sheet 3 of 3		G	