

### *ASA (6W) Isolated DC/DC Converter Module*

#### *Industry Standard Size, 1.25"x0.8"x0.4"*

#### *9-36V/18-75V Inputs, 3.3V/5V/±5V/12V/±12V/15V/±15V Outputs*

The ASA (6W) Isolated DC/DC Converter is Astec's 4:1 wide input voltage family for low power applications. With efficiency up to 81% typical for 5V module, this product is allowed to work at operating temperature range from -40°C to 71°C and a wide input voltage range of 4:1. Single-output and dual-output models are available for a wide range of applications in telecommunication, transportation equipment, etc.. Housed in small package, 1.25"x0.8"x0.4", with industry standard pinout, ASA family eases the PCB designs and mechanical designs of customers' end products.



**Industry Standard Size**  
1.25" x0.80" x 0.40"

### Special Features

- Wide 4 : 1 input range
- High efficiency, 81% @5V
- -40°C to 90°C case surface operating temperature
- Input / Output isolation 1.5KVdc
- Low output ripple and noise
- Shielded metal case with size (1.25"x0.8"x0.4")
- Industrial standard pinout
- Lead-free soldering pins
- Fixed switching frequency (200KHz)
- Built-in input filter meets EN55022 / FCC Class A without external components

### Environmental Specifications

- Operating temperature: -40°C to +71°C
- Storage temperature: -55°C to +105°C
- MTBF: >1 million hours
- RoHS Compliant

### Electrical Parameters

#### Input

|             |                           |
|-------------|---------------------------|
| Input range | 9-36 VDC; 18-75 VDC       |
| Input Surge | 50V / 100ms; 100V / 100ms |
| Efficiency  | 81% @5V (Typical)         |

#### Output

|                                  |  |
|----------------------------------|--|
| Regulation<br>(Line, Load, Temp) | <2%  |
| Ripple and noise                 | 2% typical<br>(100mV p-p max @5V)                                      |
| Transient Response               | 5% max deviation with<br>50% load to full load<br>300uS (max) recovery |
| Short Circuit Protection         | Indefinite   |

### Safety

UL, cUL 60950 Recognized (File no. E186249)  
EN 60950  
IEC 60950





## Technical Reference Note ASA (6W) Family



### ASA (6W) SERIES

THIS SPECIFICATION COVERS THE REQUIREMENTS  
FOR AN INDUSTRY STANDARD PACKAGE OF 1.25"x0.8"x0.4", 4:1 INPUT RANGE,  
6W, SINGLE OUTPUT AND DUAL OUTPUT ISOLATED DC/DC CONVERTER

#### PART NUMBERS

| MODEL NAME / SIS CODE | Nominal Vin / Range of Vin | Vout / Iout   |
|-----------------------|----------------------------|---------------|
| ASA01F18-LS           | 24V / 9-36V                | 3.3V / 1.2A   |
| ASA01A18-LS           | 24V / 9-36V                | 5V / 1A       |
| ASA00AA18-LS          | 24V / 9-36V                | ±5V / ±0.5A   |
| ASA00B18-LS           | 24V / 9-36V                | 12V / 0.5A    |
| ASA00BB18-LS          | 24V / 9-36V                | ±12V / ±0.25A |
| ASA00C18-LS           | 24V / 9-36V                | 15V / 0.4A    |
| ASA00CC18-LS          | 24V / 9-36V                | ±15V / ±0.2A  |
| ASA01F36-LS           | 48V / 18-75V               | 3.3V / 1.2A   |
| ASA01A36-LS           | 48V / 18-75V               | 5V / 1A       |
| ASA01AA36-LS          | 48V / 18-75V               | ±5V / ±0.5A   |
| ASA00B36-LS           | 48V / 18-75V               | 12V / 0.5A    |
| ASA00BB36-LS          | 48V / 18-75V               | ±12V / ±0.25A |
| ASA00C36-LS           | 48V / 18-75V               | 15V / 0.4A    |
| ASA00CC36-LS          | 48V / 18-75V               | ±15V / ±0.2A  |



## Technical Reference Note ASA (6W) Family



### ELECTRICAL SPECIFICATIONS

Unless otherwise indicated, specifications apply over all operating input voltage and temperature conditions.  
Standard test condition on a single unit:-

|            |  |
|------------|--|
| Tambient : | 25°C   |
| +Vin :     | 24V ±2% (ASAxxxx18-LS)<br>48V ±2% (ASAxxxx36-LS) |
| -Vin :     | Return pin for +Vin                              |
| +Vout :    | Connect to load                                  |
| -Vout :    | Connect to load (return)                         |

### ABSOLUTE MAXIMUM RATINGS

Stresses in excess of the absolute maximum ratings can cause permanent damage to the device. These are absolute stress ratings only. Functional operation of the device is not implied at these or any other conditions in excess of those given in the operational sections of the IPS. Exposure to absolute maximum ratings for extended periods can adversely affect device reliability.

| Parameter   | Device       | Symbol        | Min | Typ | Max  | Unit |
|---|--------------|---------------|-----|-----|------|------|
| a) Input Voltage:   |              |               |     |     |      |      |
| Continuous:   | ASAxxxx18-LS | $V_I$         | 0   | -   | 36   | Vdc  |
| Transient (100ms)   | ASAxxxx18-LS | $V_{I,trans}$ | 0   | -   | 50   | Vdc  |
| Continuous:   | ASAxxxx36-LS | $V_I$         | 0   | -   | 75   | Vdc  |
| Transient (100ms)   | ASAxxxx36-LS | $V_{I,trans}$ | 0   | -   | 100  | Vdc  |
| b) Operating Temperature  |              |               |     |     |      |      |
| Ambient   | All          | $T_A$         | -40 | -   | 71   | °C   |
| Case Surface  |              | $T_C$         | -40 | -   | 100  | °C   |
| c) Storage Temperature  | All          | $T_{STG}$     | -55 | -   | 105  | °C   |
| d) Operating Humidity   | All          | -             | -   | -   | 95   | %    |
| e) I/O Isolation<br>(Conditions : 0.5mA for 60 sec)<br>Input-Output | All          | -             | -   | -   | 1500 | Vdc  |
| f) Output Power   |              |               |     |     |      |      |
|   | 3.3V         | $P_{o,max}$   | -   | -   | 4    | W    |
|   | 5V / ±5V     | $P_{o,max}$   | -   | -   | 5    | W    |
|   | 12V / ±12V   | $P_{o,max}$   | -   | -   | 6    | W    |
|   | 15V / ±15V   | $P_{o,max}$   | -   | -   | 6    | W    |



## Technical Reference Note ASA (6W) Family



### INPUT SPECIFICATIONS

| Parameter  | Device  | Symbol          | Min             | Typ | Max | Unit     |   |
|--|---|-----------------|-----------------|-----|-----|----------|---|
| a) Operating Input Voltage   | ASAx18-LS                                       | $V_I$           | 9               | 24  | 36  | $V_{dc}$ |   |
|  | ASAx36-LS                                       | $V_I$           | 18              | 48  | 75  | $V_{dc}$ |   |
| b) Maximum Input Current<br>( $V_I = 0$ to $V_{I,max}$ ; $I_o = I_{o,max}$ ) | ASAx18-LS                                       | 3.3V            | $I_{I,max}$     | -   | -   | 1        | A |
|  |   | 5V / $\pm 5V$   | $I_{I,max}$     | -   | -   | 1.5      | A |
|  |   | 12V / $\pm 12V$ | $I_{I,max}$     | -   | -   | 2        | A |
|  |   | 15V / $\pm 15V$ | $I_{I,max}$     | -   | -   | 2        | A |
|  | ASAx36-LS                                       | 3.3V            | $I_{I,max}$     | -   | -   | 0.6      | A |
|  |   | 5V / $\pm 5V$   | $I_{I,max}$     | -   | -   | 1        | A |
|  |   | 12V / $\pm 12V$ | $I_{I,max}$     | -   | -   | 1        | A |
|  |   | 15V / $\pm 15V$ | $I_{I,max}$     | -   | -   | 1        | A |
|  | c) No Load Input Power<br>( $V_I = V_{I,nom}$ ) | All             | -               | -   | -   | 0.4      | W |
|  | d) Recommended External Fuse Ratings            | ASAx18-LS       | 3.3V            | -   | 1.5 | -        | A |
|  |   |                 | 5V / $\pm 5V$   | -   | 2   | -        | A |
|  |   |                 | 12V / $\pm 12V$ | -   | 2.5 | -        | A |
| 15V / $\pm 15V$  |   |                 | -               | 2.5 | -   | A        |   |
| ASAx36-LS  |   | 3.3V            | -               | 1   | -   | A        |   |
|  |   | 5V / $\pm 5V$   | -               | 1.5 | -   | A        |   |
|  |   | 12V / $\pm 12V$ | -               | 1.5 | -   | A        |   |
|  |   | 15V / $\pm 15V$ | -               | 1.5 | -   | A        |   |

**CAUTION: This power module is not internally fused. An input fuse must always be used.**



# Technical Reference Note ASA (6W) Family



## OUTPUT SPECIFICATIONS

| Parameter   | Device            | Symbol              | Min    | Typ    | Max    | Unit     |
|---|-------------------|---------------------|--------|--------|--------|----------|
| a) Output Voltage Setpoint<br>( $V_I = V_{I, \min}$ to $V_{I, \max}$ ; $I_o = I_{o, \max}$ ;<br>$T_A = 25^\circ\text{C}$ )  | 3.3V              | $V_{o, \text{set}}$ | 3.23   | 3.30   | 3.37   | $V_{dc}$ |
|   | 5V                | $V_{o, \text{set}}$ | 4.90   | 5.00   | 5.10   | $V_{dc}$ |
|   | 12V               | $V_{o, \text{set}}$ | 11.76  | 12.00  | 12.24  | $V_{dc}$ |
|   | 15V               | $V_{o, \text{set}}$ | 14.70  | 15.00  | 15.30  | $V_{dc}$ |
|   | ±5V               | $V_{o, \text{set}}$ | ±4.90  | ±5.00  | ±5.10  | $V_{dc}$ |
|   | ±12V              | $V_{o, \text{set}}$ | ±11.76 | ±12.00 | ±12.24 | $V_{dc}$ |
|   | ±15V              | $V_{o, \text{set}}$ | ±14.70 | ±15.00 | ±15.30 | $V_{dc}$ |
| b) Output Regulation:<br>Line ( $V_I = V_{I, \max}$ to $V_{I, \min}$ ; $I_o = I_{o, \max}$ )<br><br>Load ( $V_I = V_{I, \text{nom}}$ ; $I_o = I_{o, \min}$ to $I_{o, \max}$ )<br><br>Cross ( $V_I = V_{I, \text{nom}}$ ; $I_o = +I_{o, \max}, -I_{o, \min}$<br>or $+I_{o, \min}, -I_{o, \max}$ to $+I_{o, \max}, -I_{o, \max}$ )<br><br>Temperature<br>( $T_c = -40^\circ\text{C}$ to $+90^\circ\text{C}$ ) | All               | -                   | -      | -      | 0.5    | %        |
|   | All               | -                   | -      | -      | 0.5    | %        |
|   | ±5V/±12V/±15V     | -                   | -      | -      | 4      | %        |
|   | All               | -                   | -      | -      | 1.0    | % $V_o$  |
| c) Output Ripple and Noise<br>(Across 1 $\mu\text{F}$ @50V, X7R ceramic capacitor<br>& 10 $\mu\text{F}$ @25V tantalum capacitor)<br>See Figure 1.<br>Peak-to-Peak (5 Hz to 20 MHz)  | 3.3V/5V/±5V       | -                   | -      | -      | 100    | mVp-p    |
|   | 12V/±12V/15V/±15V | -                   | -      | -      | 120    | mVp-p    |
| d) Rated Output Current<br>Single Output<br><br>Dual Output   | 3.3V              | $I_o$               | 120    | -      | 1200   | mA       |
|   | 5V                | $I_o$               | 100    | -      | 1000   | mA       |
|   | 12V               | $I_o$               | 50     | -      | 500    | mA       |
|   | 15V               | $I_o$               | 40     | -      | 400    | mA       |
|   | ±5V               | $I_o$               | ±50    | -      | ±500   | mA       |
|   | ±12V              | $I_o$               | ±25    | -      | ±250   | mA       |
|   | ±15V              | $I_o$               | ±20    | -      | ±200   | mA       |
| e) Efficiency<br>( $V_I = V_{I, \text{nom}}$ ; $I_o, \max$ ; $T_A = 25^\circ\text{C}$ )   | 3.3V              | -                   | -      | 78     | -      | %        |
|   | 5V                | -                   | -      | 81     | -      | %        |
|   | 12V               | -                   | -      | 82     | -      | %        |
|   | 15V               | -                   | -      | 83     | -      | %        |
|   | ±5V               | -                   | -      | 82     | -      | %        |
|   | ±12V              | -                   | -      | 83     | -      | %        |
|   | ±15V              | -                   | -      | 83     | -      | %        |
| f) Switching Frequency  | All               | -                   | 180    | 200    | 220    | KHz      |

### OUTPUT SPECIFICATIONS (Cont.)

| Parameter   | Device                         | Symbol | Min | Typ | Max | Unit      |
|---|--------------------------------|--------|-----|-----|-----|-----------|
| g) Dynamic Response :<br>( $\Delta I_o/\Delta t = 0.08A/\mu s$ ;<br>$V_I = V_{I, nom}$ ; $T_A = 25^\circ C$ ) |                                |        |     |     |     |           |
| Load Change from $I_o = 50\%$ to<br>100% of $I_{o, max}$  | 3.3V/5V/ $\pm 5V$              | -      | -   | -   | 5   | % $V_o$   |
|   | 12V/ $\pm 12V$ /15V/ $\pm 15V$ | -      | -   | -   | 2   | % $V_o$   |
| Peak Deviation Settling Time<br>(to $V_{o, nom}$ )  | All                            | -      | -   | -   | 300 | $\mu sec$ |
| h) Output Voltage Overshoot<br>( $I_o = I_{o, max}$ ; $T_A = 25^\circ C$ )                                    | All                            | -      | -   | 1   | 4   | % $V_o$   |

### FEATURE SPECIFICATIONS

| Parameter  | Device       | Symbol | Min | Typ  | Max | Unit       |
|--|--------------|--------|-----|------|-----|------------|
| Undervoltage Lockout<br>Turn-on Point                          | ASAxxxx18-LS | -      | -   | -    | 9   | V          |
|  | ASAxxxx36-LS | -      | -   | -    | 18  | V          |
| Turn-off Point   | ASAxxxx18-LS | -      | -   | 5    | -   | V          |
|  | ASAxxxx36-LS | -      | -   | 10   | -   | V          |
| Isolation Capacitance  | All          | -      | -   | 1000 | -   | PF         |
| Isolation Resistance   | All          | -      | 10  | -    | -   | M $\Omega$ |
| Calculated MTBF<br>( $I_o = I_{o, max}$ ; $T_A = 25^\circ C$ ) | All          | -      | 1M  | -    | -   | Hours      |
| Weight   | All          | -      | -   | -    | 20  | g          |

## Basic Operation and Features

The ASA converters were designed specifically to address applications where high power density is required. These modules provide 1500V isolation and operate from the input ranges of 9V-36V and 18V-75V with standard features such as OCP.

## Output Overcurrent Protection

To provide protection in an output overload or short circuit condition, the converter is equipped with current limiting circuitry and can endure the fault condition for an unlimited duration. At the point of current-limit inception, the converter goes into “Hiccup Mode”, causing the output current to be limited both in peak and duration. The converter operates normally once the output current is brought back into its specified range.

## TEST SETUP

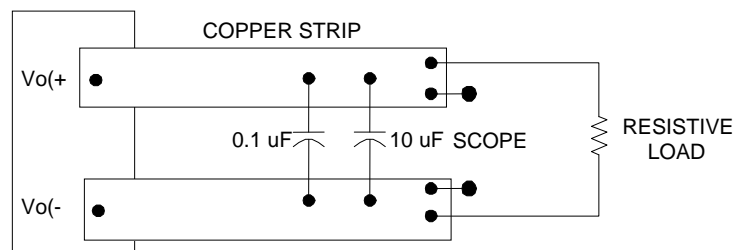

Note: Use a  $0.1 \mu\text{F}$  @50V X7R ceramic capacitor and a  $10 \mu\text{F}$  @25V tantalum capacitor. Scope measurement should be made using a BNC socket. Position the load between 51 mm and 76 mm (2 in. and 3 in.) from module.

**Figure 1 : Peak-to-Peak Output Noise Measurement Test Setup**

Performance Curves – Efficiency Curve

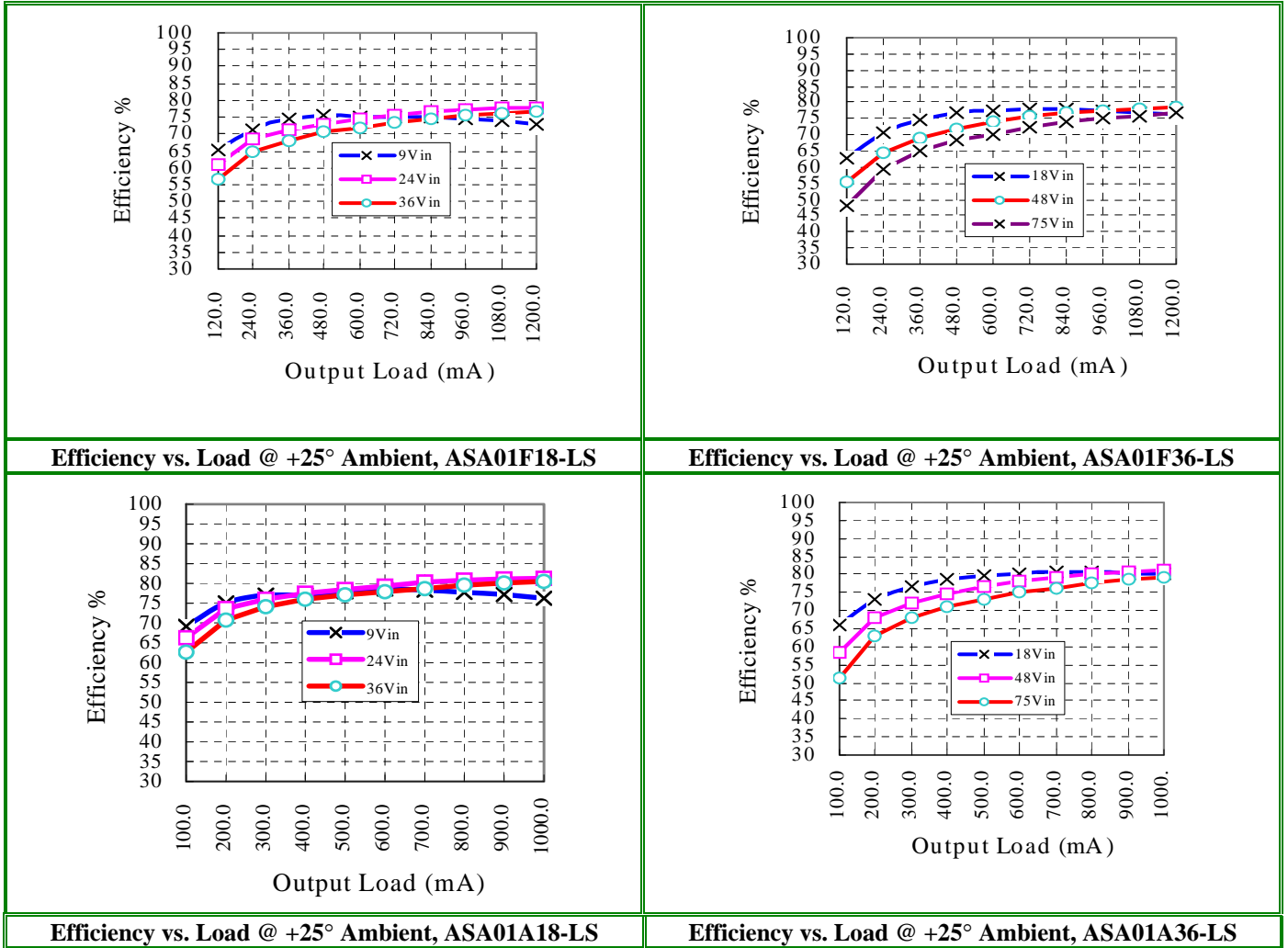



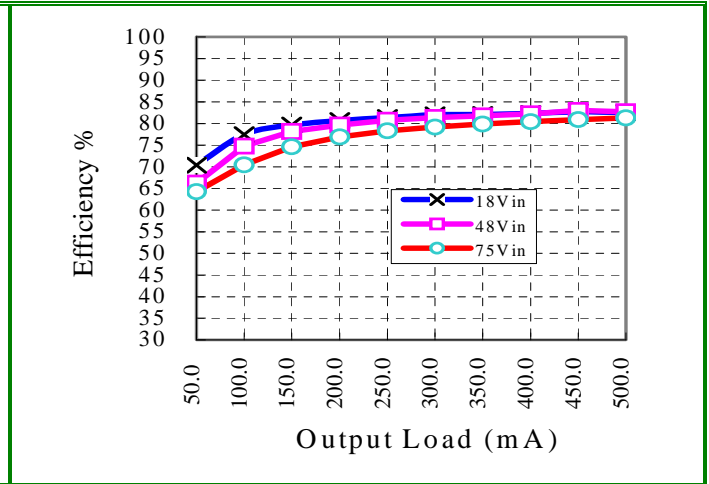
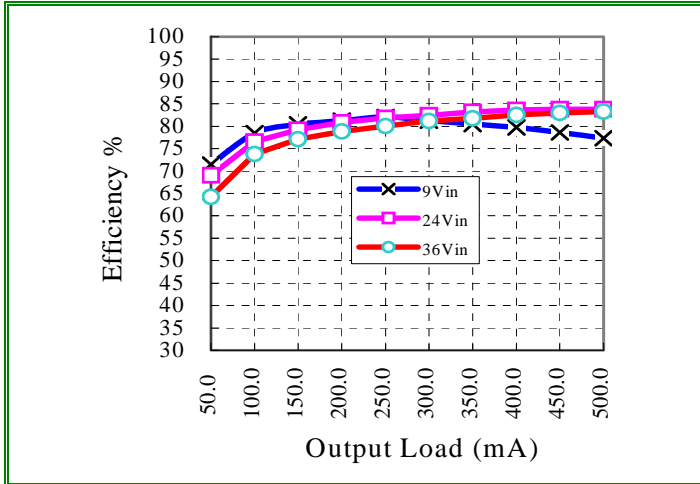

Efficiency vs. Load @ +25° Ambient, ASA00B18-LS

Efficiency vs. Load @ +25° Ambient, ASA00B36-LS

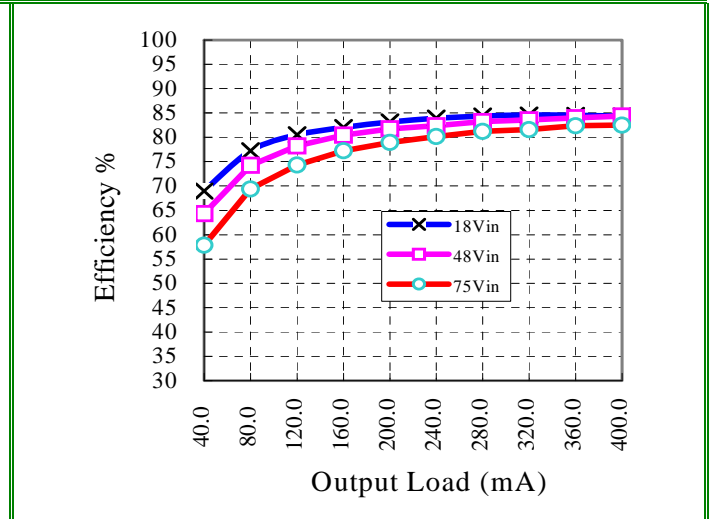
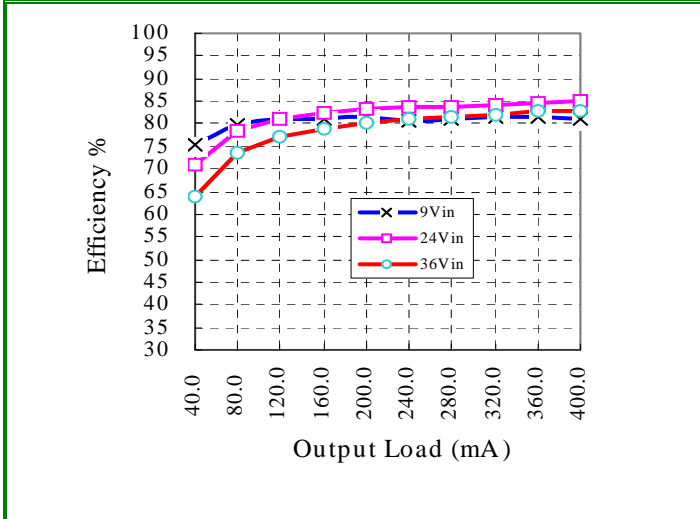

Efficiency vs. Load @ +25° Ambient, ASA00C18-LS

Efficiency vs. Load @ +25° Ambient, ASA00C36-LS



# Technical Reference Note ASA (6W) Family

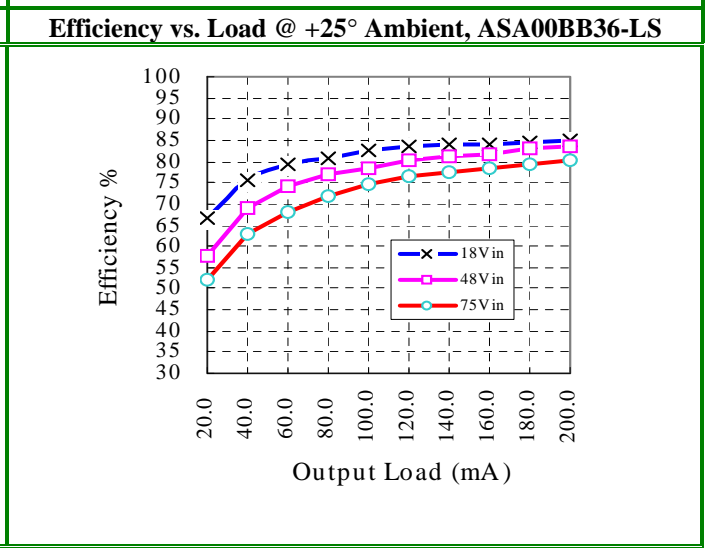
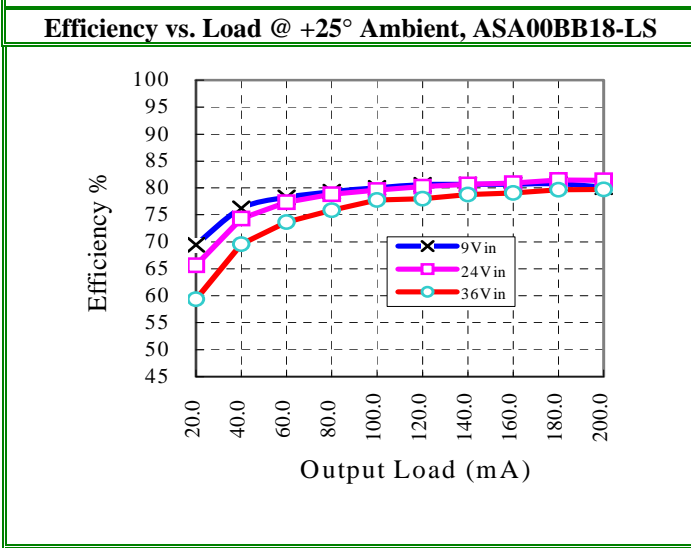
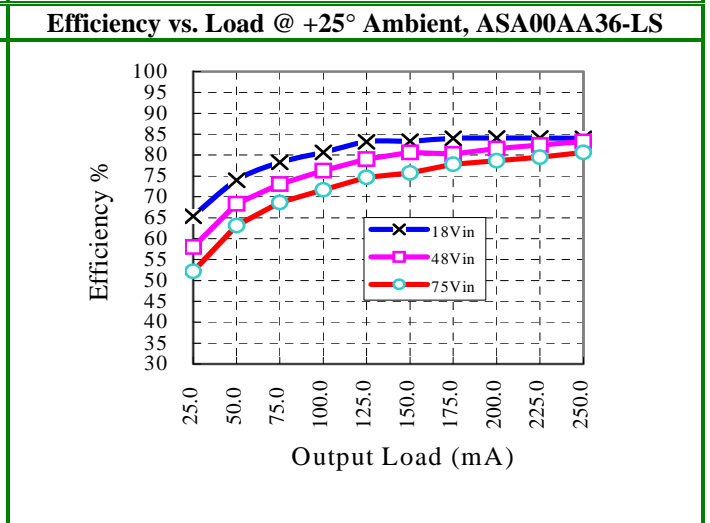
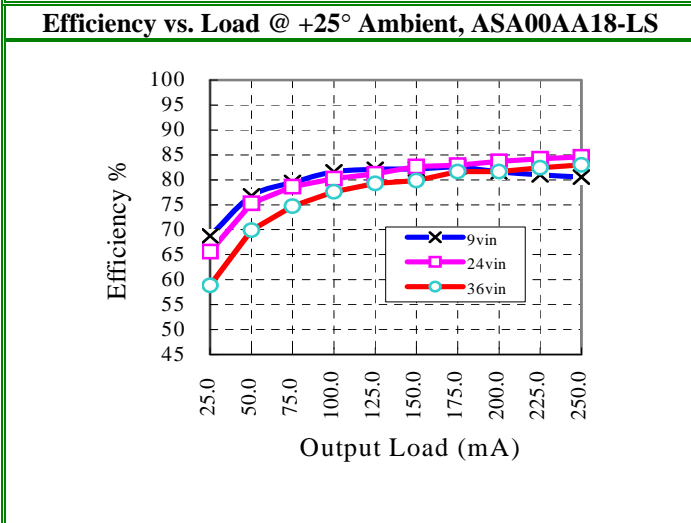
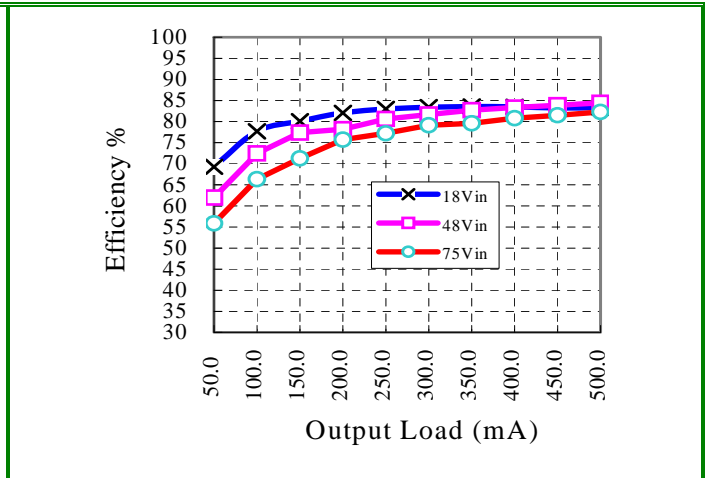
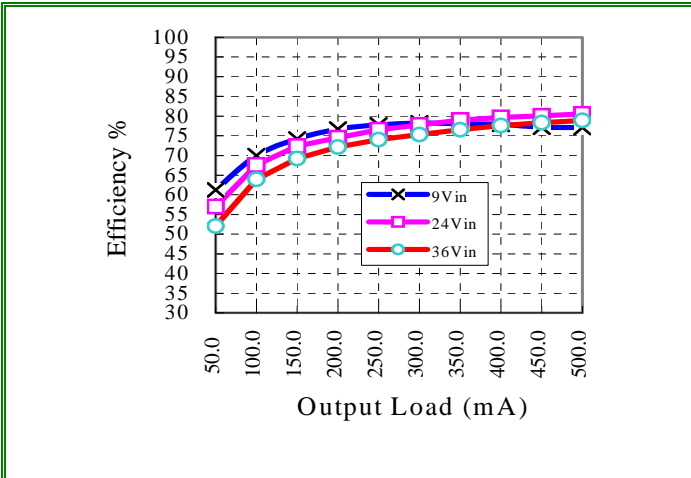

Efficiency vs. Load @ +25° Ambient, ASA00CC18-LS

Efficiency vs. Load @ +25° Ambient, ASA00CC36-LS

### Performance Curves

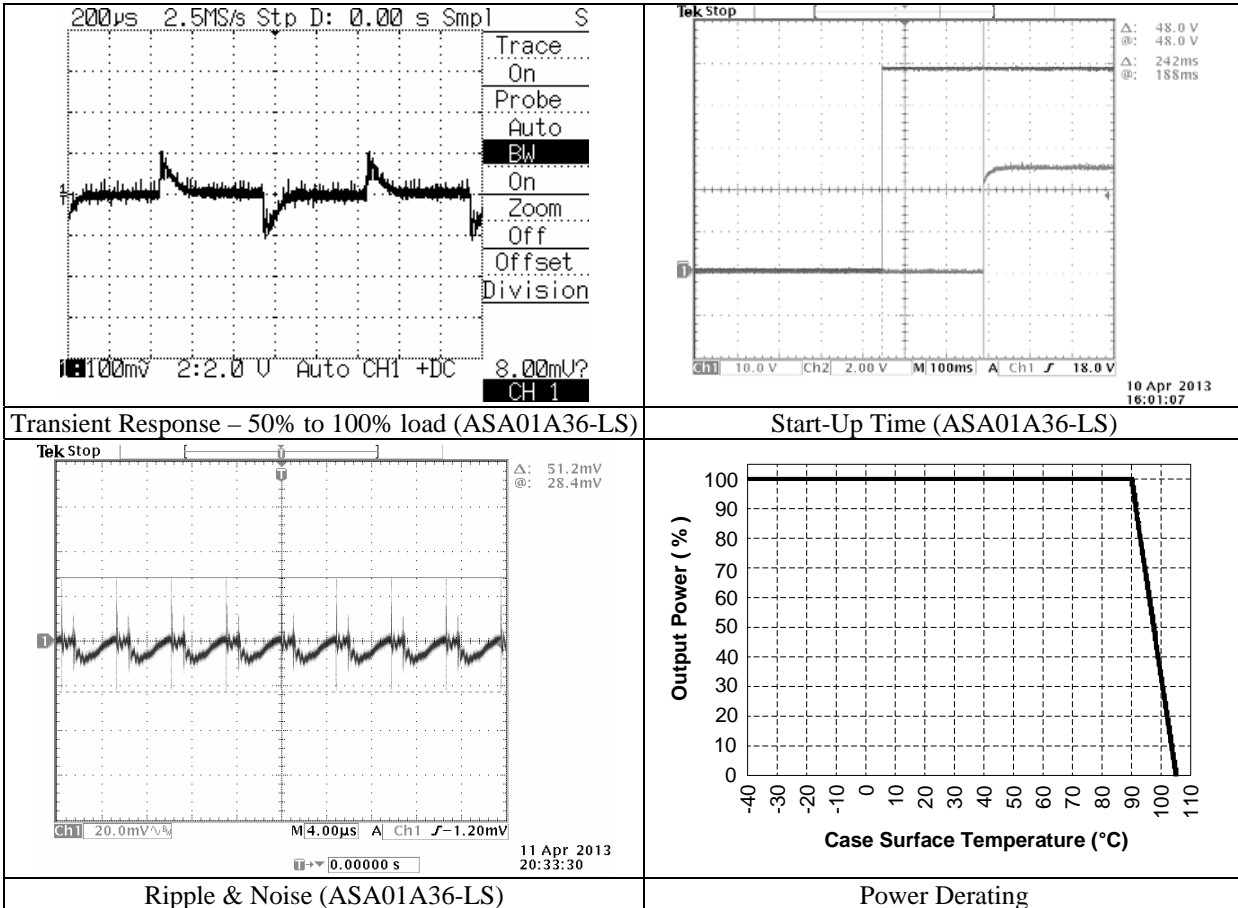



# Technical Reference Note ASA (6W) Family



## Conducted EMI Performance

EUT : Converter Power: 24Vdc  
 M/N: ASA01A18-L Test mode : FULL LOAD  
 POL: LINE ENGINEER : AGUN Temp: 24.1 Humidity : 55%

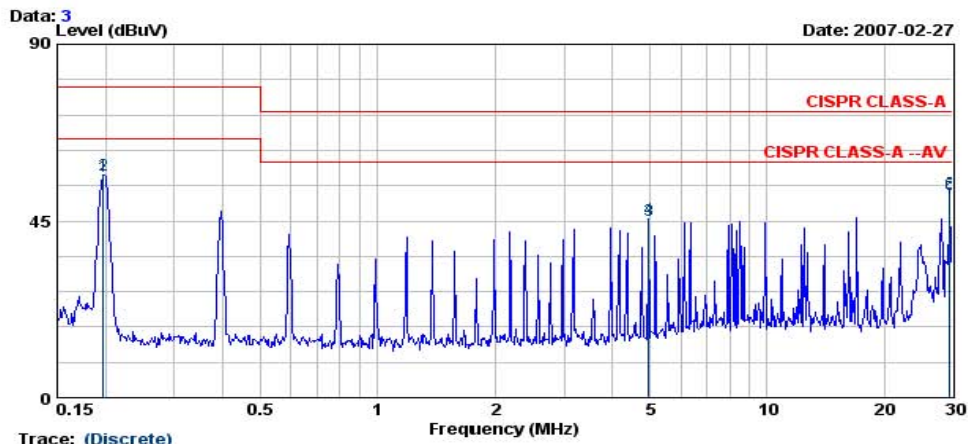

Trace: (Discrete)

| Freq. MHz | LISN Factor dB | Cable Loss dB | Meter Reading dBuV | Measured Level dBuV | Limits dBuV | Over Limits dBuV | Detector |
|-----------|----------------|---------------|--------------------|---------------------|-------------|------------------|----------|
| 0.198     | 9.80           | 0.05          | 46.37              | 56.22               | 79.00       | -22.78           | QP       |
| 0.198     | 9.80           | 0.05          | 46.75              | 56.60               | 66.00       | -9.40            | AVERAGE  |
| 4.957     | 9.82           | 0.24          | 34.97              | 45.03               | 73.00       | -27.97           | QP       |
| 4.957     | 9.82           | 0.24          | 35.35              | 45.41               | 60.00       | -14.59           | AVERAGE  |
| 29.544    | 10.09          | 0.27          | 41.66              | 52.02               | 73.00       | -20.98           | QP       |
| 29.544    | 10.09          | 0.27          | 41.49              | 51.85               | 60.00       | -8.15            | AVERAGE  |



# Technical Reference Note ASA (6W) Family



EUT : Converter Power: 24Vdc  
 M/N: ASA01A18-L Test mode : FULL LOAD  
 POL: NEUTRAL ENGINEER : AGUN Temp: 24.1 Humidity : 55%

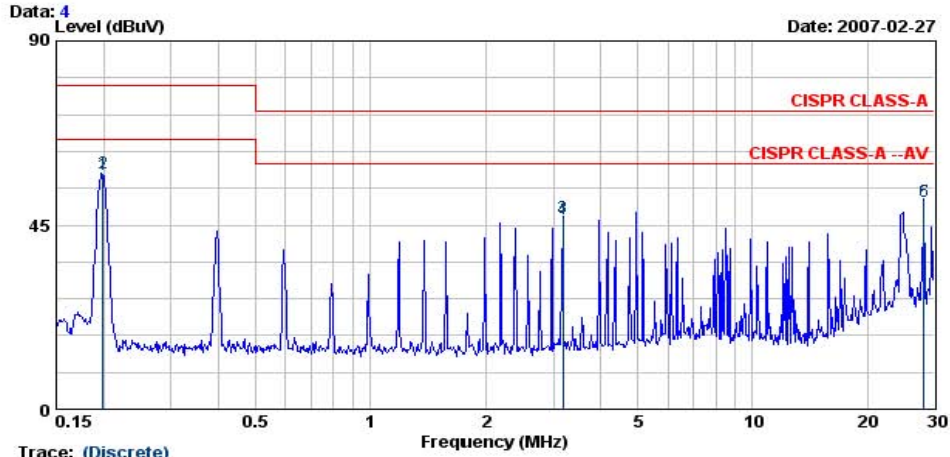

Trace: (Discrete)

| Freq.<br>MHz | LISN<br>Factor<br>dB | Cable<br>Loss<br>dB | Meter<br>Reading<br>dBuV | Measured<br>Level<br>dBuV | Limits<br>dBuV | Over<br>Limits<br>dBuV | Detector |
|--------------|----------------------|---------------------|--------------------------|---------------------------|----------------|------------------------|----------|
| 0.199        | 9.80                 | 0.05                | 47.37                    | 57.22                     | 79.00          | -21.78                 | QP       |
| 0.199        | 9.80                 | 0.05                | 47.69                    | 57.54                     | 66.00          | -8.46                  | AVERAGE  |
| 3.173        | 9.87                 | 0.10                | 36.91                    | 46.87                     | 60.00          | -13.13                 | AVERAGE  |
| 3.173        | 9.87                 | 0.10                | 36.56                    | 46.52                     | 73.00          | -26.48                 | QP       |
| 28.158       | 10.06                | 0.37                | 40.25                    | 50.69                     | 73.00          | -22.31                 | QP       |
| 28.158       | 10.06                | 0.37                | 40.22                    | 50.66                     | 60.00          | -9.34                  | AVERAGE  |

## Mechanical Dimensions and Module Pin Assignment

### Single Output

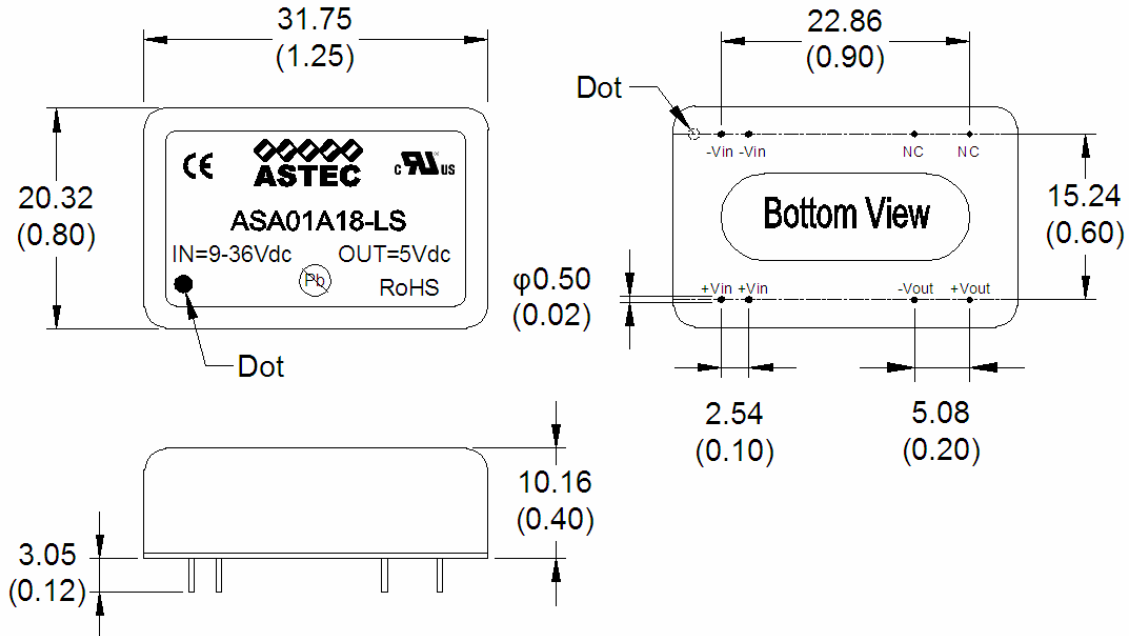

### Dual Output

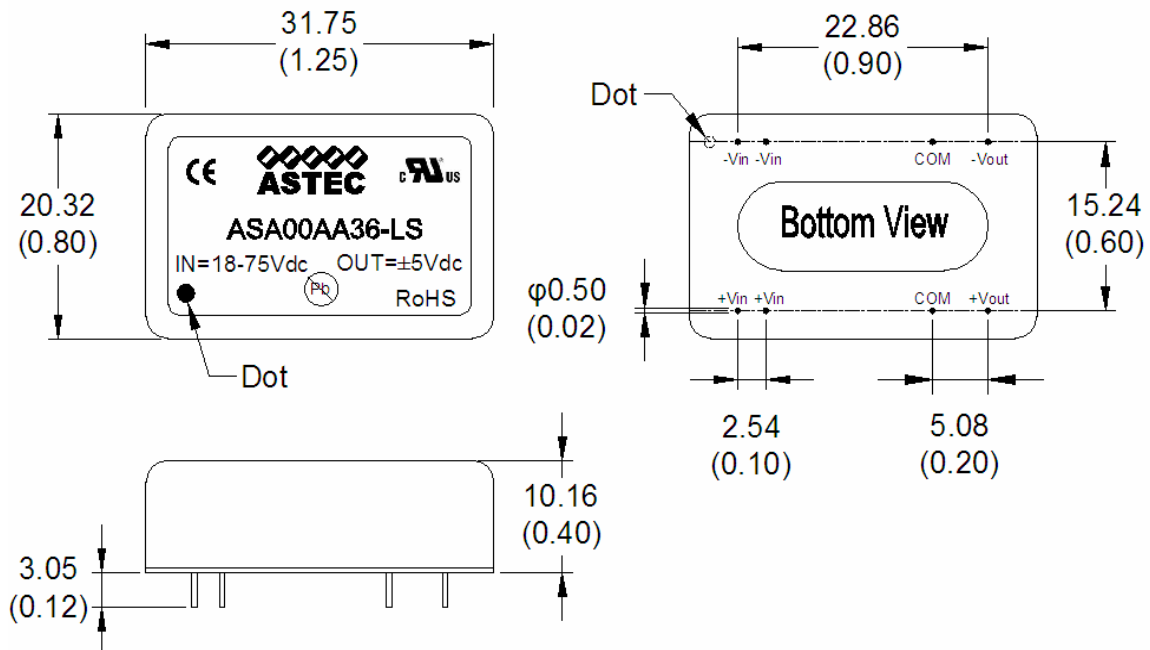

**Package Information**

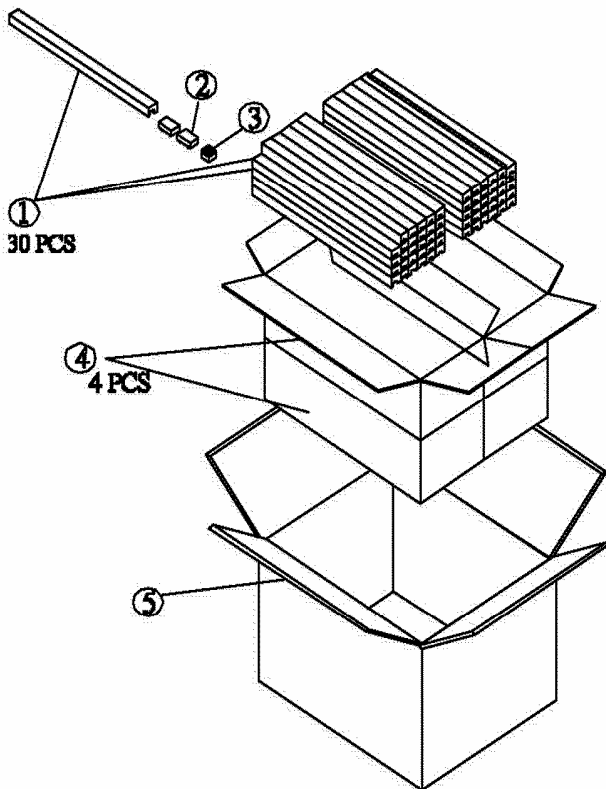

1. PACKING TUBE: 345\*22.2\*16.7mm ; ONE TUBE = 10 PCS
2. PRODUCTS: ASA SERIES
3. STOPPER
4. INNER CARTON: 388\*159\*263mm  
ONE INNER CARTON = 30 TUBES = 300PCS
5. OUTER CARTON: 405\*334\*263mm  
ONE OUTER CARTON = 4 INNER CARTONS = 1200PCS

| STANDARD TOLERANCE LIMITS<br>UNLESS OTHER SPECIFIED. |           |
|--|-----------|
| RANGE  | TOLERANCE |
| >0~3   | ±0.10     |
| >3~5   | ±0.15     |
| >5~30  | ±0.18     |
| >30~120  | ±0.20     |

### Recommended Lead-Free Wave Soldering Temperature Profile

