

# K2F003UCH

cam changeover switch - 3-pole - 45° - 20 A -  
for Ø 22 mm



## Main

Range of product	Harmony K
Product or component type	Complete cam switch
Component name	K2
[Ith] conventional free air thermal current	20 A
Product mounting	Front mounting
Fixing mode	Ø 22 mm hole
Cam switch head type	With front plate 45 x 45 mm
Type of operator	Black handle, length = 35 mm
Rotary handle padlocking	Without
Presentation of legend	With metallic legend, 2 - 0 - 1 black marking
Cam switch function	Changeover switch
Return	Without
Off position	With Off position
Poles description	3P
Switching positions	Left: 0° - 315° Right: 0° - 45°
IP degree of protection	IP65 conforming to IEC 529 IP65 conforming to NF C 20-010

## Complementary

Switching angle	45 °
[Ui] rated insulation voltage	690 V degree of pollution 3 conforming to IEC 60947-1
[Ithe] conventional enclosed thermal current	16 A
Electrical durability	200000 cycles AC-23 200000 cycles AC-3 600000 cycles AC-15 600000 cycles AC-21
Operating rate	2.5 cyc/mn AC-21 2.5 cyc/mn AC-23 2.5 cyc/mn AC-3 8.333 cyc/mn AC-15
Short-circuit current	10000 A
Short circuit protection	20 A by cartridge fuse, type gG
[Uimp] rated impulse withstand voltage	4 kV in isolating function 6 kV conforming to IEC 947-1
Contacts operation	Slow-break
Positive opening	With
Electrical connection	Captive screw clamp terminals flexible, 2 x 1.5 mm <sup>2</sup> Captive screw clamp terminals solid, 1 x 2.5 mm <sup>2</sup>
Mechanical durability	1000000 cycles
CAD overall width	45 mm
CAD overall height	50 mm
CAD overall depth	69 mm
Product weight	0.19 kg

The information provided in this documentation contains general descriptions and/or technical characteristics of the performance of the products contained herein. This documentation is not intended as a substitute for and is not to be used for determining suitability or reliability of these products for specific user applications. It is the duty of any such user or integrator to perform the appropriate and complete risk analysis, evaluation and testing of the products with respect to the relevant specific application or use thereof. Neither Schneider Electric Industries SAS nor any of its affiliates or subsidiaries shall be responsible or liable for misuse of the information contained herein.

## Environment

Standards	CENELEC EN 50013 EN 60947-3 for power circuit EN 60947-5-1 for control circuit IEC 60947-3 for power circuit IEC 60947-5-1 for control circuit
Product certifications	CSA 240 V 1 hp 1 phase CSA 240 V 3 hp 3 phases 2 -pole(s) UL 240 V 1 hp 3 phases UL 240 V 0.33 hp 1 phase 2 -pole(s)
Protective treatment	TC
Ambient air temperature for operation	-25...55 °C
Ambient air temperature for storage	-40...70 °C
Shock resistance	30 gn conforming to IEC 68-2-27
Vibration resistance	5 gn, 10...150 Hz conforming to IEC 68-2-6
Class of protection against electric shock	Class II conforming to IEC 536 Class II conforming to NF C 20-030
RoHS EUR status	Compliant
RoHS EUR conformity date	0910

---

Operating Head and Body with Plastic Base

---

Front Mounting by  $\varnothing 22$  mm/0.87 in. Hole

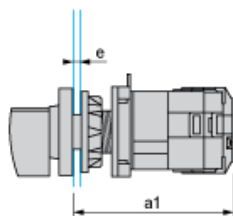

a1 90.5 mm/3.53 in.

e support panel thickness 1 mm to 6 mm./0.039 in. to 0.24 in.

Link Positions (Factory Mounted)

Diagram for 1 to 4-pole Switches

Select the number of poles according to the product characteristics.

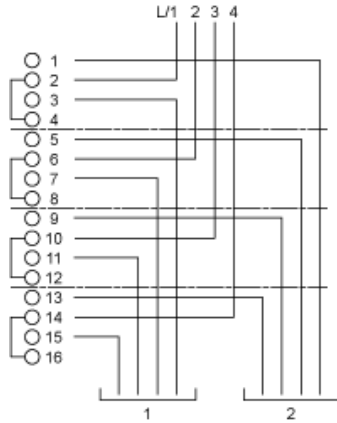

Marking

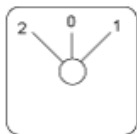

Angular Position of Switch

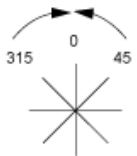

Switching Program

Diagram for 1 to 4-pole Switches

Select the number of poles according to the product characteristics.

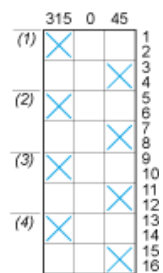



- (1) 1-pole
- (2) 2-pole
- (3) 3-pole
- (4) 4-pole

## Convention Used for Switching Program Representation

---

 Contact closed

 Contact closed in 2 positions and maintained between the 2 positions

 Sealed assembly for auto-maintain control

 Overlapping contacts

 Spring return position: for a switching angle of  $90^\circ$ , spring return is over  $30^\circ$  after the last position (for a maximum of 3 simultaneous contacts).

Example:

