

Motor Starting & Protection solutions for Conveyor Systems (UL)

Warehouse logistics



Keep conveyors up and running thanks to ABB's Motor Starting & Protection solutions that ensure continuous operation, enhanced safety and protection for your warehouse.

What are Conveyor Systems?

Conveyor systems allow safe and efficient transport from one location to another for a wide variety of materials. They are especially useful in applications involving the transport of heavy or bulky materials, which makes them very popular in the material handling and packaging industries.

Why do you need Motor Starting & Protection solutions for conveyors?

To keep conveyors in your warehouse up and running and to save your business from downtime, you need motor starting and protection solutions to be able to deliver continuity of service in any condition, and enhanced safety to avoid injury hazards.



Main benefits

Continuous Operation

Even in simple electromechanical starter combinations, ensure continuous operation to keep conveyor systems up and running in any condition thanks to ABB's solutions that enable coordination in all major network topologies.



Safety and protection

Our product specifications often exceed standard requirements, allowing you to enhance safety, reduce hazards, and prevent downtime.



Compact and easy to install

Save up to 50% space in the control panel, thanks to narrower designs in AF contactors and electronic compact starters. Save time during the installation phase using our readymade starter connection kits to make compact and safe connections.



Energy efficient system

Make your conveyor panel energy-efficient, thanks to AF coil technology that reduces contactor coil energy consumption by 80%, dissipates less heat, leading to a reduction in temperature rise. In this way, installation density in the panel can be increased.

Conveyor Systems

Typologies, standards and scope

A conveyor system is a common piece of mechanical handling equipment that moves materials from one location to another.

Conveyors allow quick and efficient transport for a wide variety of materials, but they are especially useful in applications involving the transportation of heavy or bulky materials, which makes them very popular in the material handling and packaging industries.

Why Conveyors are important:



Reliable for material handling while adding speed, efficiency, and safety.



Faster transit of products allowing quicker pick/pack/dispatch times resulting in higher volumes.



Free up resources by reducing the personnel required for material handling.



Reduce personnel movement and forklift truck traffic.



Move products smoothly from one location to another and reduce product and pallet damage.



Main typologies

- **Gravity conveyors:** Gravity conveyors are non-powered solutions that use gravity or some external force to move products. They are one of the most economical materials handling solutions and are easy to install and relocate since they do not utilize motorized parts.
- **Roller conveyors:** Roller conveyors are a series of rollers supported within a frame where objects can be moved either manually, by gravity, or by power.
- **Spiral conveyors:** The Spiral conveyor is a compact and versatile elevating solution. A spiral conveyor can be designed to carry products between floors. Designed with a uniform slope, the Spiral conveyor ensures smooth operation without disturbing the product.
- **Belt Conveyors:** A belt conveyor is a carrying medium that uses a continuous belt to transport products in a straight line or through changes in height or direction. The belt conveyor is one of the best options for handling bulky materials.
- **Flexible conveyors:** Flexible conveyors flex and change shapes to fill gaps, bridge to trucks, and more. Both power and gravity are available.
- **Sortation conveyors:** Sortation conveyors are used to direct products from one conveyor line to another. These are tailored to each operation in order to properly identify, track and transport products to expedite the order fulfillment process.
- **Incline conveyors:** Inclined Conveyors are used to bring products from one level to another via a hinged or flexible belt. Products can be controlled by cleats on the belt during elevation.
- **Extendable conveyors:** Extendable conveyors bridge the gap between the end of a conveyor system and your dock doors. They let you control the length of the conveyor so that it extends as far as needed in the trailer for loading and unloading.
- **Overhead conveyors:** These conveyors suspend loads from a powered chain with specialized carriers that gently support awkward items.
- **Pallet conveyors:** Pallet handling conveyors are designed to move pallets and other heavy-duty loads on belts, chains, skate wheels, or rollers. They carefully move large and heavy products safely, increasing system throughput for industries utilizing these large loads.



Belt Conveyor



Turntable roller

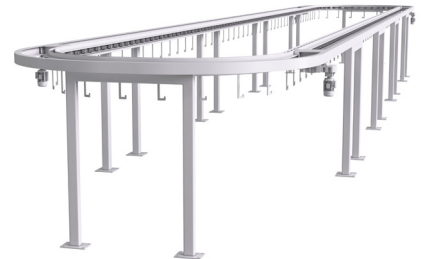

Overhead conveyor

Applicable standards

- ANSI/CEMA 402-2003 (R2015) - USA
- ASME B20.1-2018 And ANSI B11.19-2020 -
- Conveyor belts for general use - Electrical and fire safety requirements - ISO 12882:2015
- Machine Safety – ISO 13849

Scope

Main scope for conveyors systems are:

- **Mechanical design:** designing the structure of the conveyor system in terms of shape, size, and load capacity. The focus is on pulleys (head & tail), rollers, conveying material/type and other components.
- **Electrical:** Conveyors can be passive, with products moved manually over rollers, or with the help of gravity. In general, though, they are driven by AC and DC motors, either directly or through reduction gears, chains or sprockets. Here, the designer will select motors and starters depending on their need for protection functions, and whether the system uses constant or variable speed.
- **Safety:** conveyors can be secured in two different ways:
 - 1. Mechanical safety:** covers and guards serve as physical barriers and keep a safer distance from moving parts, pinch points, and other danger zones. This limited access equates to fewer accidents and injuries.
 - 2. Electrical safety:** If a conveyor needs to be stopped suddenly for any reason, all of the safety devices for example, emergency stops, light curtains, rope pulls need to be easily accessible and plainly visible so that anyone working in the area can reach them.
- **Automation:** An automated conveyor system refers to any automation that reduces or eliminates the need for human interaction to check-in, check out, sort material, loading, unload, label, and more. It uses sensors to detect material presence and then performs the designed action based on the level of automation. Automated systems may also use robots for the movement of products.

Conveyor control panels in warehouse logistics

The start-up of whole conveyor systems in a warehouse is controlled by the conveyor control panel. In case a conveyor needs to be stopped suddenly for a safety reason, the safety logic device (e.g. safety relay) in the control panel translates the input received from all of the safety products for

example, emergency stops, light curtains and rope pulls and shuts down conveyors safely using output devices like redundant safety contactors (e.g. AFS Safety Contactors) or electronic compact starters (e.g. HF range).

Electrical safety in a roll conveyor

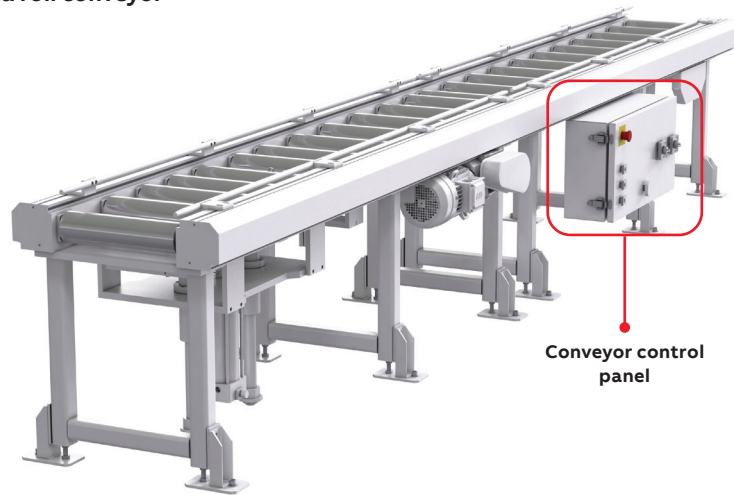

The motor size and type selection to start conveyors is done based on the product weight, dimensions (length, width, height), and flow rate/speed of the conveyor system. The starter type selection is based on the speed and accuracy needed for the type of conveyor system. Variable frequency drives can be used if a system needs speed control.

ABB's scalable and comprehensive motor starting product line provides complete flexibility to choose the right starting solution for **full-speed motor control** for any conveyor system in a warehouse.

Starter types:

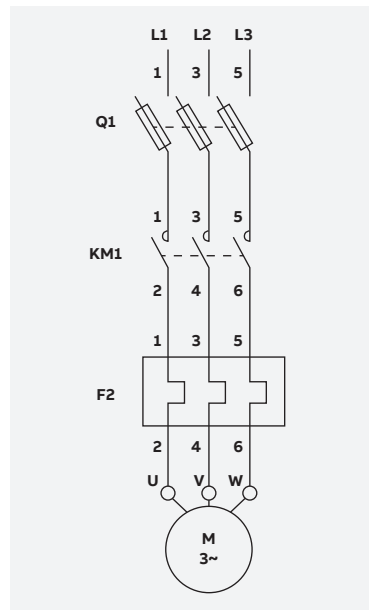

Direct-on-line starter

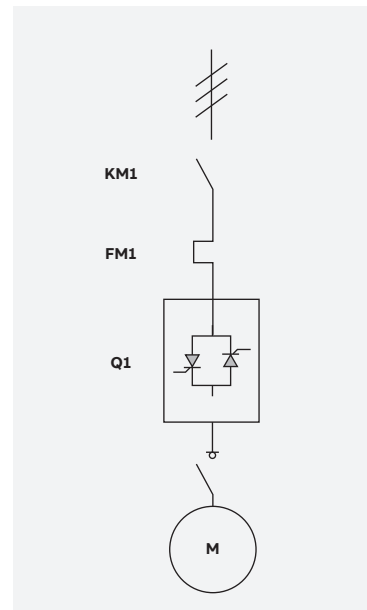

Softstarter starter

Design data requirement for conveyor control panel

Parameters for designing the starter control panel

- Motor rated voltage
- Motor rated current
- Maximum operating current
- Short circuit current rating
- Starting torque depending on the conveyor type
- Acceleration time (starting time)
- Control voltage
- Ambient temperature
- Altitude
- Starter type
- Operations - Auto / Manual & Local / remote.
- Digital connectivity (control/monitor)
- Machine safety requirements depending on risk assessment acc. to ISO 12100 (safety function, e.g. Safety relay/controller, emergency stop, light curtains)

Main protection functions

- Short-circuit protection
- Overload protection (with the adjustable current setting)
- Voltage level monitoring
- Phase loss & phase sequence – for correct direction of the conveyor
- Earth fault protection

Supporting functions

- Jammed conveyor – by locked rotor protection
- Broken belt detection – by an underload/current protection
- Thermistor motor protection - for monitoring the winding temperature.
- Digital connectivity (control, energy measurements, supervision)

Motor Starting and Protection solutions for conveyors in warehouse logistics

Discover ABB's Motor Starting and Protection solutions to safely start and stop conveyors in warehouses, where they will keep your business running.

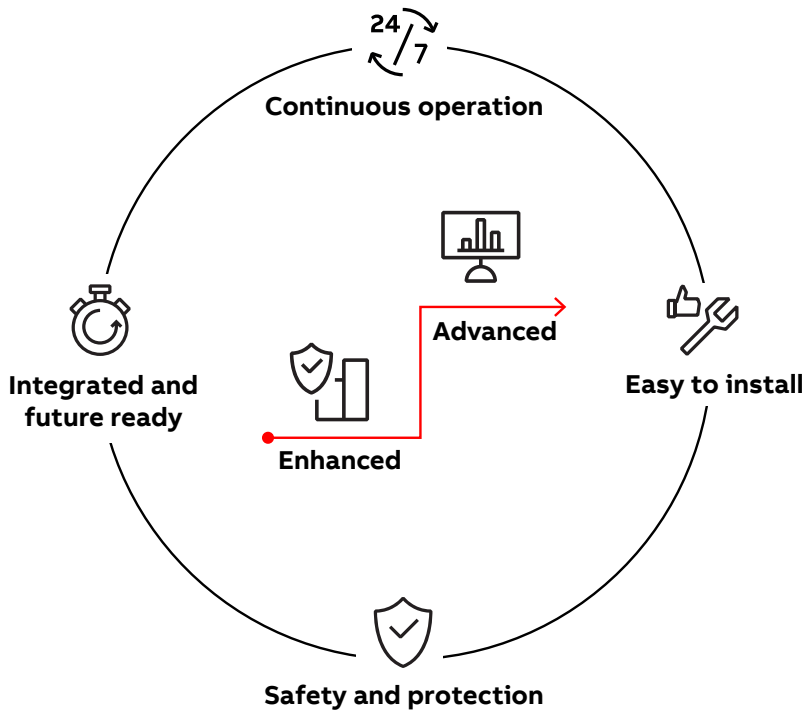

Enhanced Solution | Get robust protection with enhanced safety, control and monitoring
 With the Enhanced Solution we ensure that combinations of core power devices work in coordination, while providing enhanced control, safety and monitoring for applications in the field of discrete automation.
 The Enhanced solution for conveyor systems in warehouses includes additional protection functions like **temperature monitoring, thermistor motor protection relay, under or over voltage monitoring relay, safety relays, safety emergency stop, safety controller etc.** Based on the request, we can address any other requirements.

Advanced Solution | Get ahead with smart data and predictive applications, to keep your conveyor system running at all the time.
 The Advanced solution for conveyor system in warehouse includes integrated and future ready motor protection, flexible motor control, fault diagnostics and maintenance and supports all major communication protocols.

This table gives an overview of possible functions in different solution offerings for conveyor systems in warehouses.

Solution level	Basic protection functions	Monitoring of additional protection functions	Digital connectivity and cloud monitoring
Enhanced	●	●	
Advanced	●	●	●



ENHANCED

ABB's enhanced solution for Conveyor

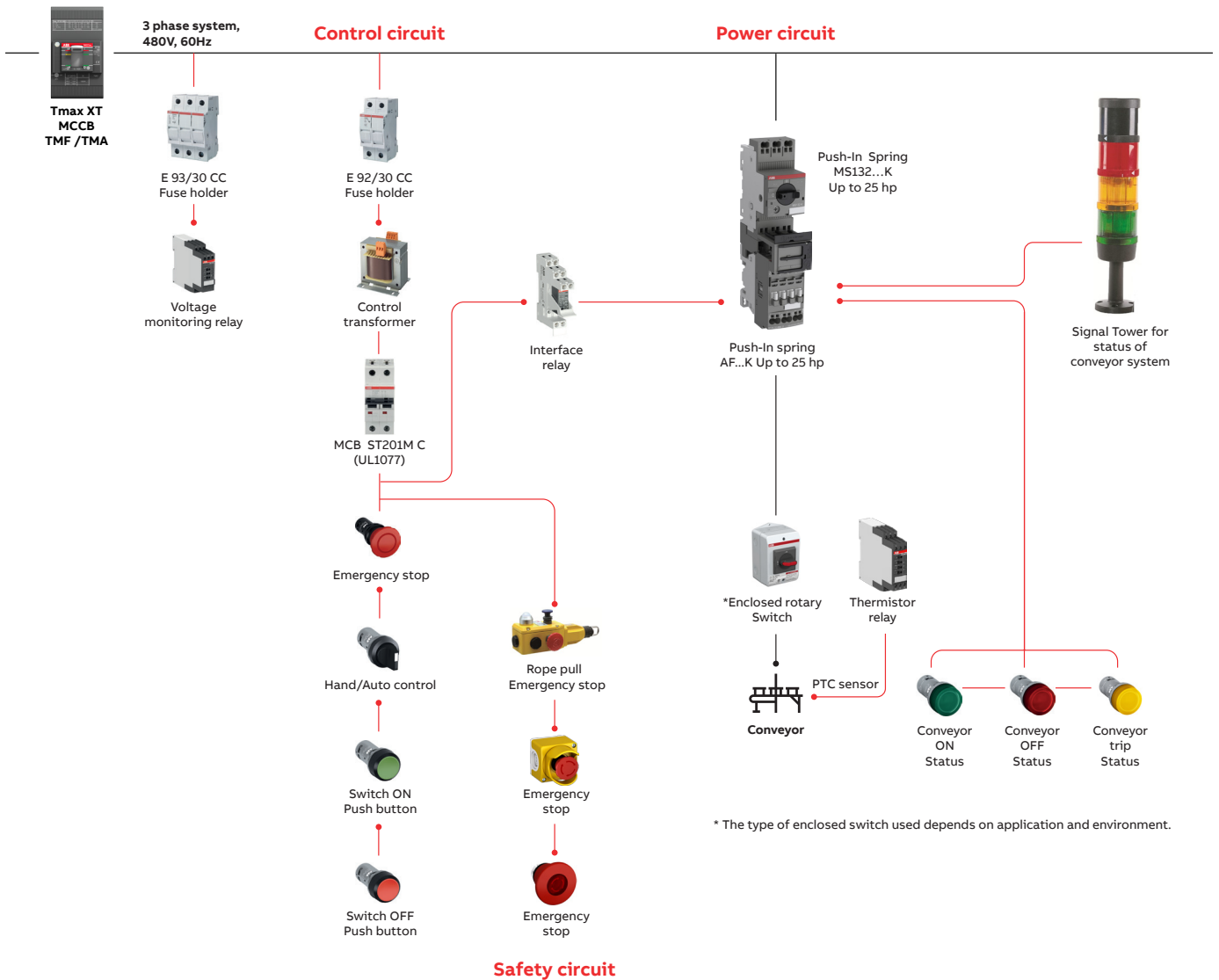

Features

- For full speed conveyor systems
- Fuseless protection with manual motor starter up to 25 hp for Push-in spring version.
- Provide basic protection for conveyor motor like overload, short circuit and enhanced protection by adding monitoring relays thermistor and under/over-voltage protection.
- Ensure basic safety circuit by adding a rope pull switch and emergency stop.

Note: MMS - Manual Motor Starter

This architecture full fills with a very low safety level because the safety circuit is connected to the standard interface relay.



ENHANCED

ABB's enhanced solution for Conveyor with Sentry safety relay

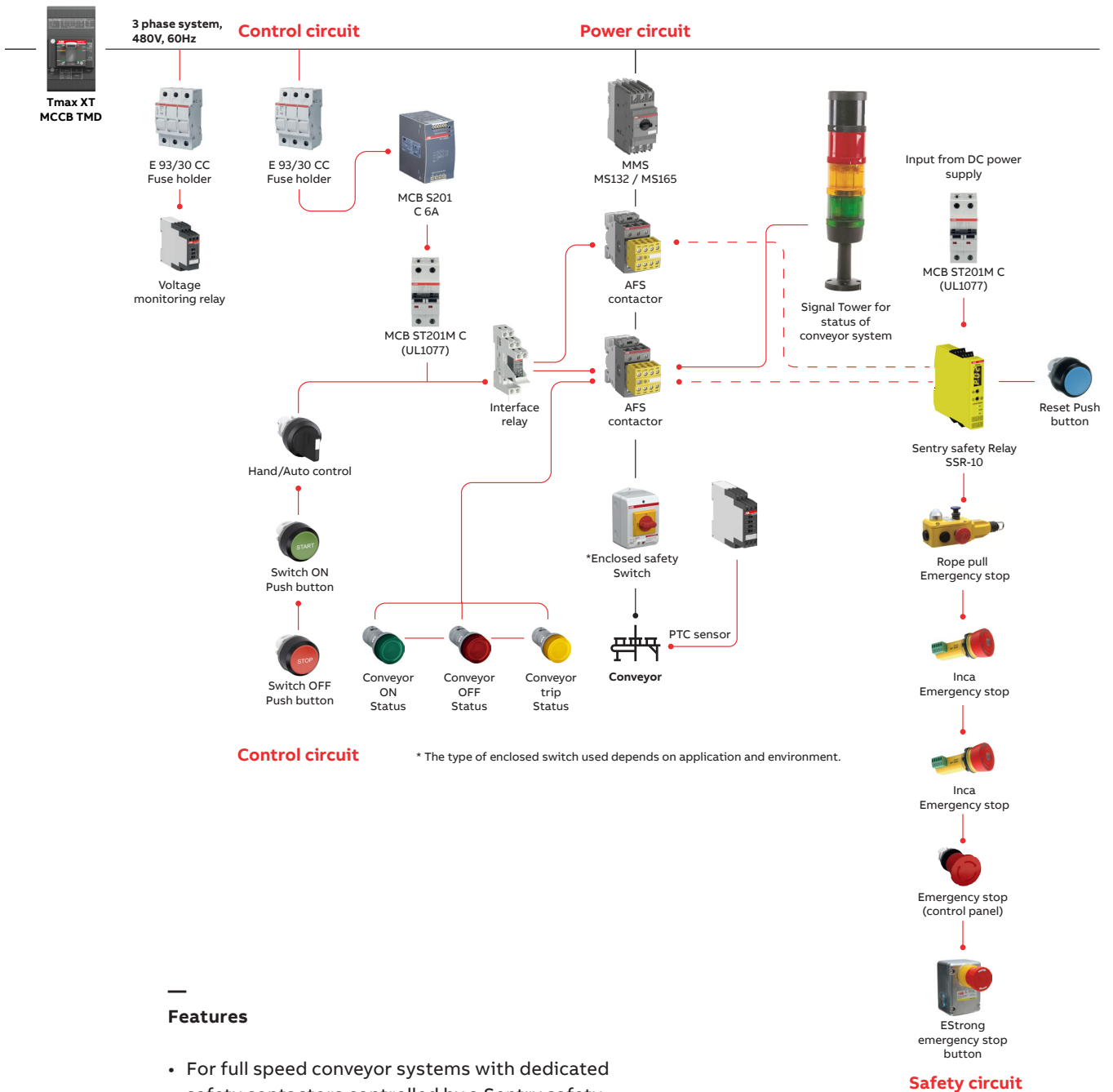

Features

- For full speed conveyor systems with dedicated safety contactors controlled by a Sentry safety relay ensure a higher level of safety and performance.
- Fuseless protection with manual motor starter up to 60 hp.
- Provide basic protection for conveyor motor like overload, short circuit and by adding monitoring relays thermistor and under/over-voltage protection.
- AFS contactor complies with main standards EN ISO 13849 and EN 62061 - guaranteeing the safe use of conveyor system.
- Mechanically linked and mirrored contacts in the AFS contactor provide the performance required in monitoring circuits.
- Safety chain easily identified by products with the yellow housing



ENHANCED

ABB's enhanced solution for Conveyor with Sentry safety relay

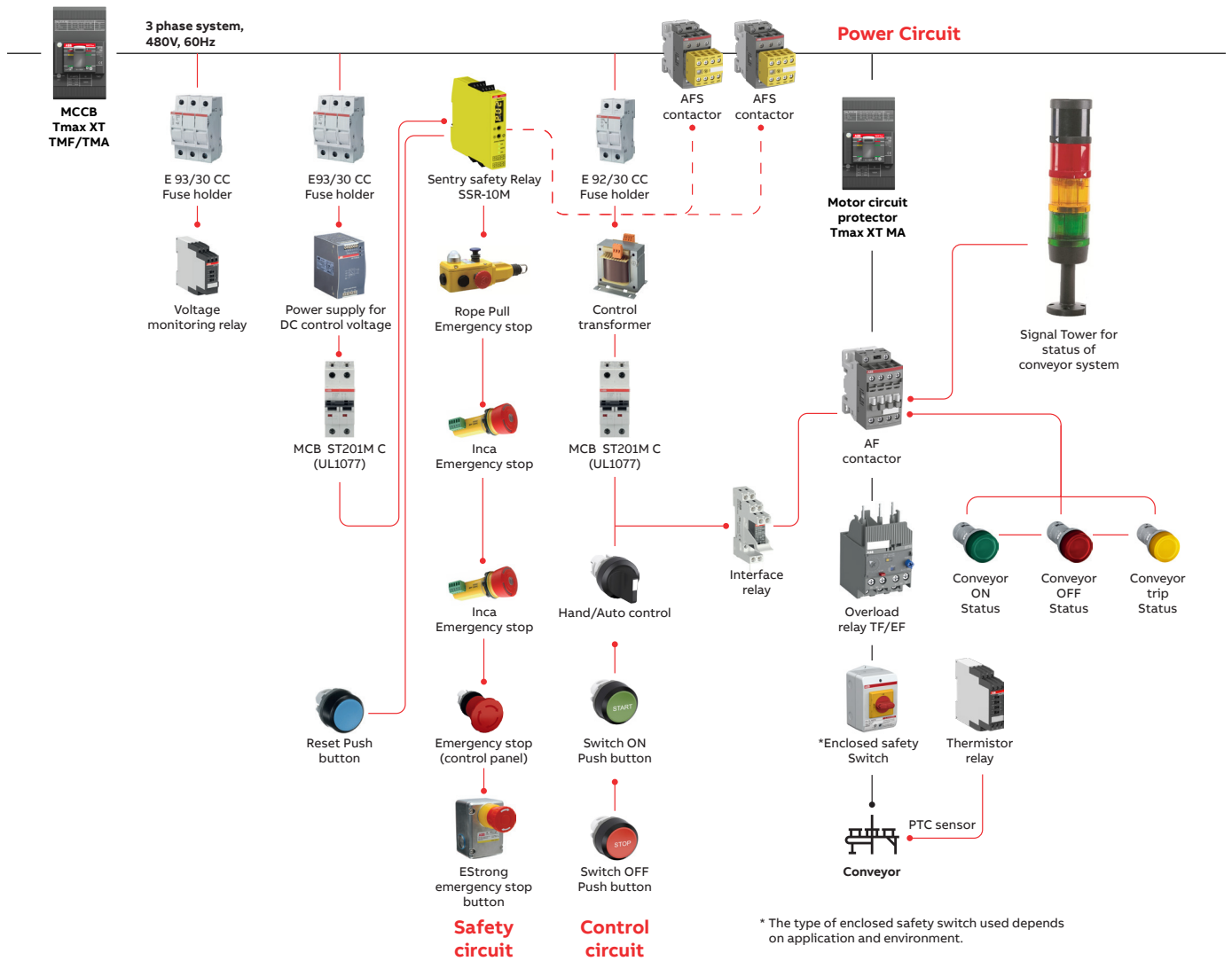

Features

- For full speed conveyor systems with dedicated safety contactors controlled by a Sentry safety relay ensure a higher level of safety and performance.
- Fuseless protection with manual motor starter up to 60 hp.
- Provide basic protection for conveyor motor like overload, short circuit and by adding monitoring relays thermistor and under/over-voltage protection.
- AFS contactor complies with main standards EN ISO 13849 and EN 62061 - guaranteeing the safe use of conveyor system.
- Mechanically linked and mirrored contacts in the AFS contactor provide the performance required in monitoring circuits.
- Safety chain easily identified by products with the yellow housing

ABB's enhanced solution for Conveyor

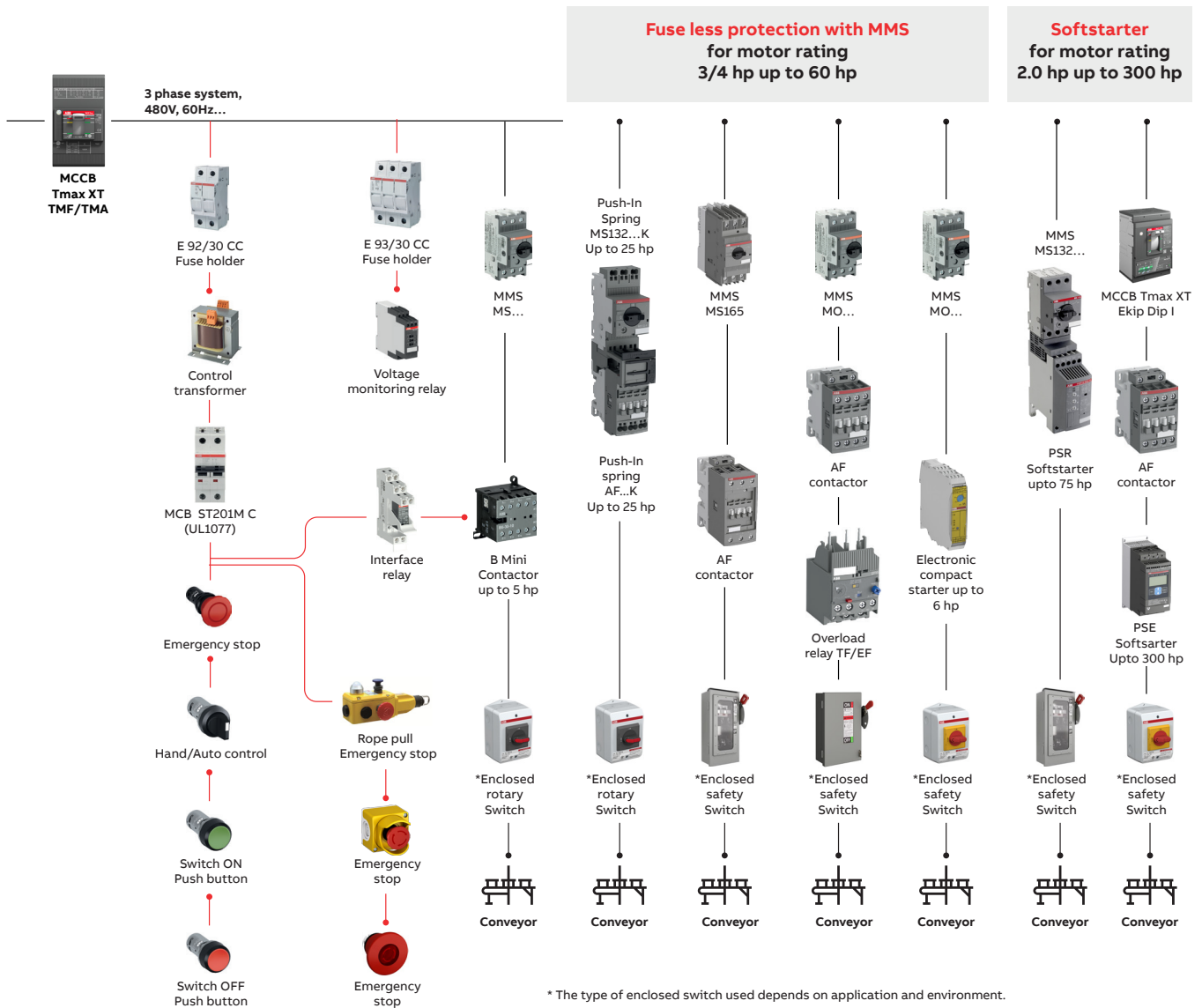

The table gives an overview of difference between the combination products offered in enhanced solution for conveyor system in warehouse

Product combination	Motor rating supports	Key Diffentiator
B Mini contactor	up to 5 hp	For efficiency and spacing saving
contactor + MMS (Push-In Spring)	up to 25 hp	For a reliable connection, faster, and easier wiring and also vibration proof
contactor + MMS + OLR(Screw version)	up to 60 hp	For standard offerings
PSR + MMS(Softstarter)	up to 75 hp	For Smooth start and stop
Switch fuse + PSE(Softstarter)	up to 300 hp	For Smooth start and stop

Note: This architecture full fills with a very low safety level because the safety circuit is connected to the standard interface relay.

ABB's advanced solution for Conveyor

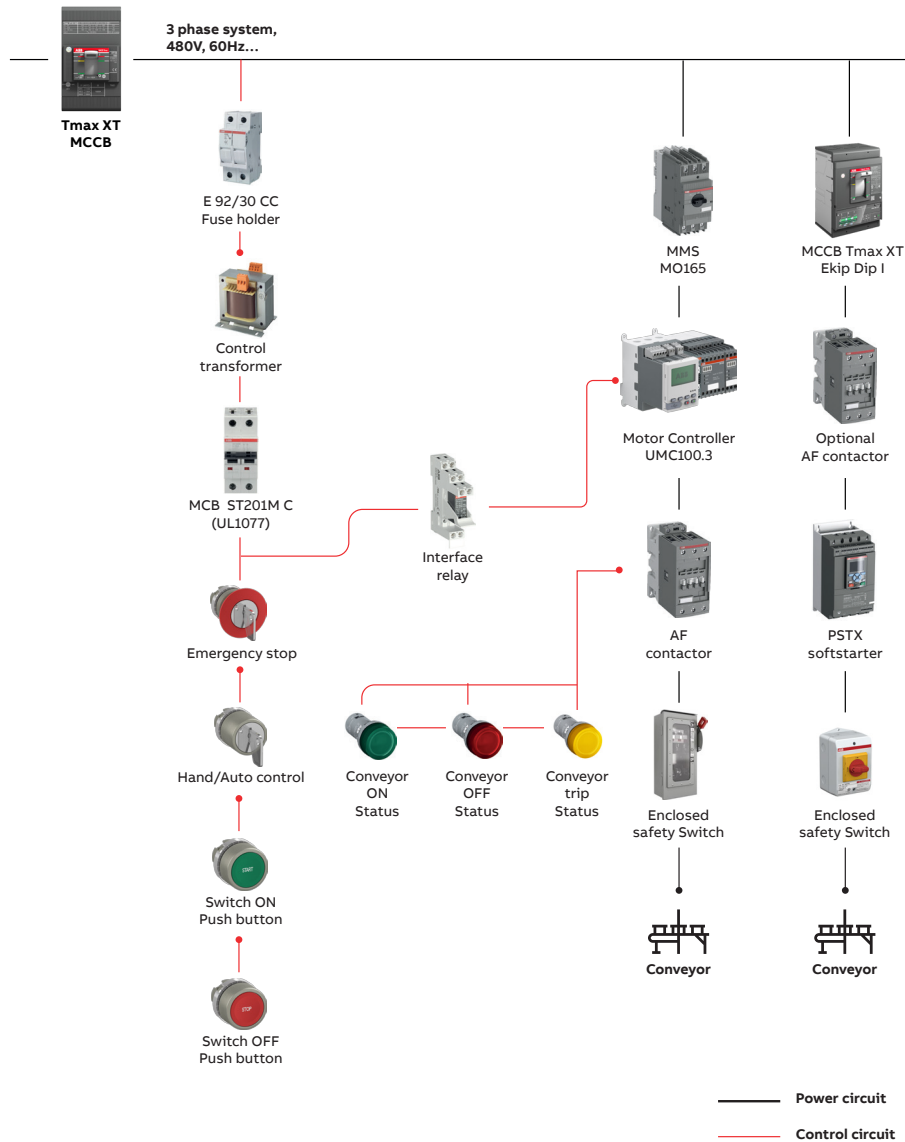

Features

- Flexible conveyor control (remote or local)
- Advanced protection functions embedded
- Status and fault diagnosis through keypad and communication
- Monitoring of all electrical parameters
- Supports all the major communication protocol.

Note: The enclosed safety switch shown will be close to the conveyor motor in case the conveyor system needs maintenance to isolate the power supply and to ensure safety for a person working close to that conveyor.

Digital offering

Discover ABB's digital offering for Smart conveyor systems, which helps conveyors run more smoothly, in terms of both operation and maintenance, thanks to smart data measurement.

ABB's advanced motor starting solution provides simple control and monitoring of the conveyor system, allowing you to identify issues with ease, which enables you to take preemptive action to reduce failures and unscheduled downtime.



Your conveyor system's data is always available, to help you predict wear, schedule maintenance, and reduce downtime.



Flexible remote control and monitoring of conveyor system.



ABB Ability™ Energy and Asset Manager, data is always quickly available via web applications, and it is possible to connect to a third-party PLC/controller.

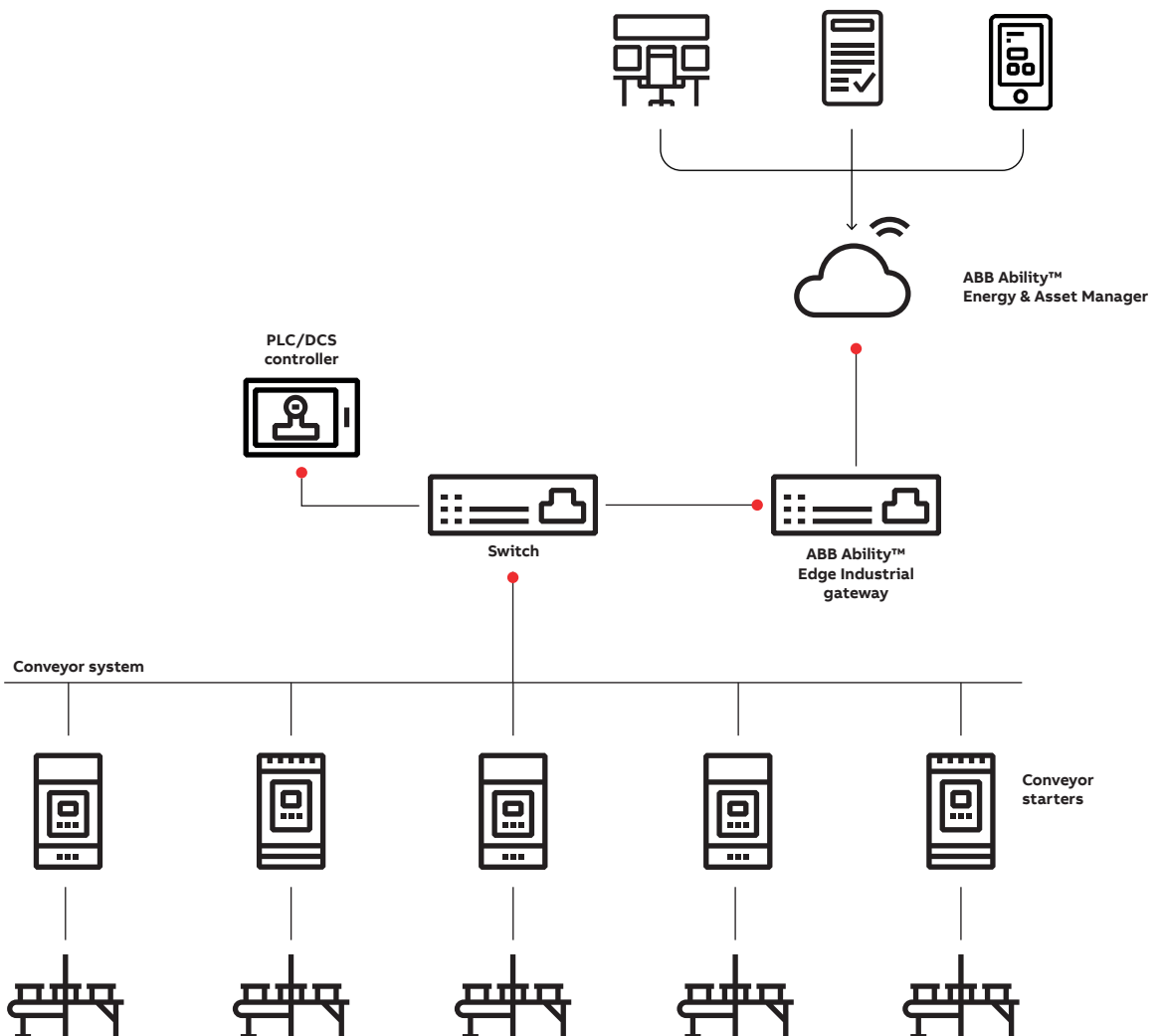



ADVANCED

ABB's advanced solution for Conveyor with Softstarter and Pluto safety controller

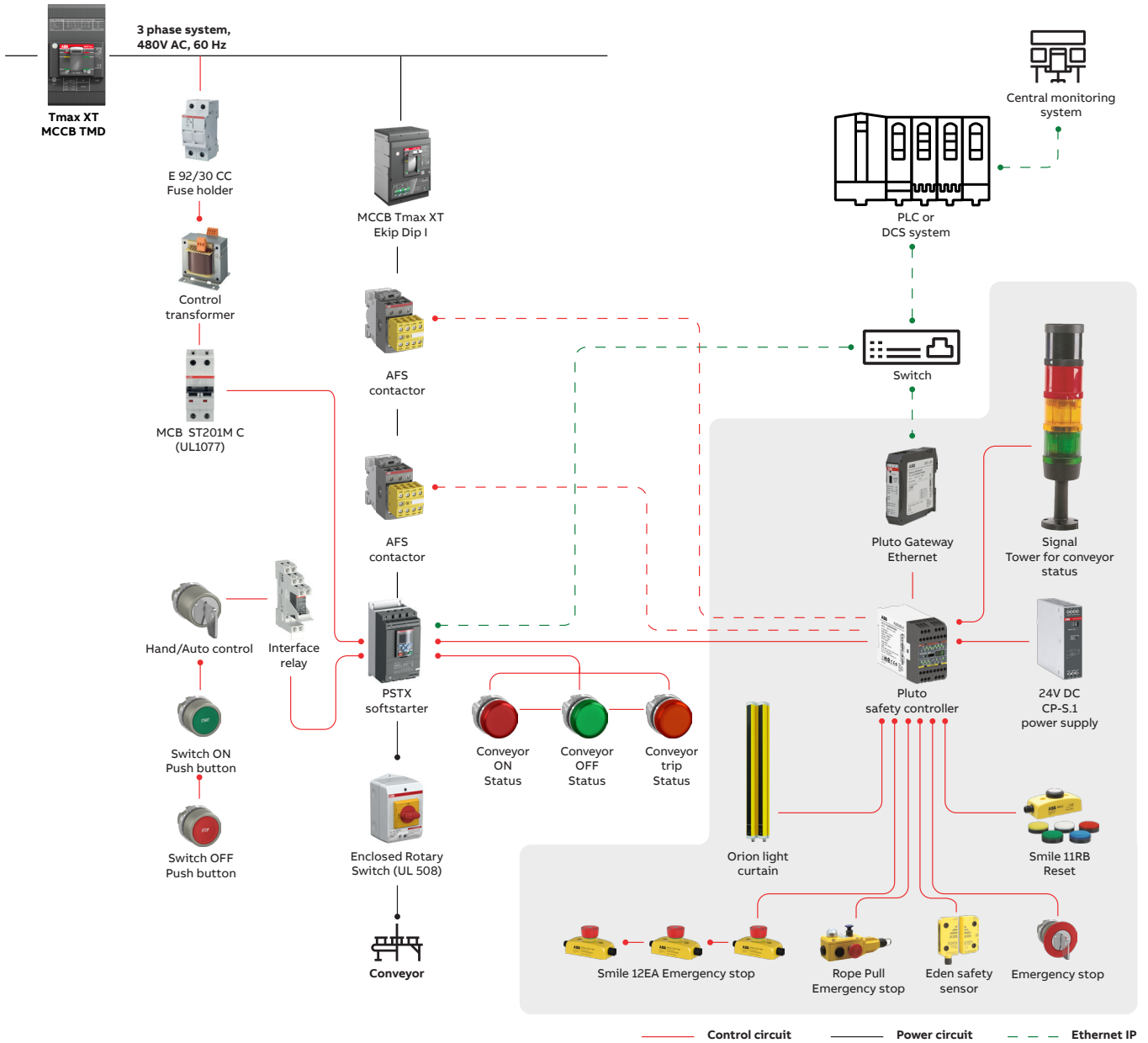

Supporting communication protocols

Industrial Ethernet

- Ethernet/IP™ (2-port)
- Modbus TCP (2-port)
- Profinet (2-port)
- EtherCAT
- BACnet MS/TP

Fieldbus

- Modbus RTU
- DeviceNet™
- Profibus DP

Note:

(1) For softstarter a separate Ethernet Anybus module to be selected.
 (2) DYNlink connection possible with Pluto safety controller:
 The DYNlink connection is a unique solution that allows up to 10 DYNlink devices to be connected in series to a Pluto input while still reaching up to Cat. 4/PL e/SIL3. This saves inputs and cabling, since to reach the same level with standard two-channel safety devices, two inputs are necessary and series connection is not possible.

Features

- Flexible conveyor control (remote or local)
- Advanced protection functions embedded
- Status and fault diagnosis through local display/communication.
- Monitoring of all electrical parameters
 - Voltage (V)
 - Current (A)
 - Power factor (Cos phi)
 - Active power (kW/HP)
 - Reactive power (kVAR)
 - Apparent power (kVArh)
 - Main frequency (Hz)
 - Total Harmonics distortion (THD)
 - Consumed Energy in kWh
 - Motor temperature
- Dedicated programmable safety controller for monitoring all the safety devices to ensure higher reliability and a safe conveyor system.

Bill of Material

Enhanced level - Motor starting and protection solution for Standalone conveyor motor in Logistics warehouses

List of parameters that were taken into consideration for the development of the bill of materials (For reference only)

Standard	UL
System Design	Main Voltage 480 / 277V AC, 3 phase, 60 Hz, 65kA, control voltage -24V DC
Starter type	Direct-online starter with standard screw solution + dedicated safety contactor
UL - CMC Type	Type-F (two components)
System Power	1x Conveyor motor -3 hp (4.80 A FLA)

BOM, conveyor, enhanced, UL, 3HP, 480V/277, 65kA, AFS contactor + SSR10 safety relay, 24VDC CTRL, type F CMC

Product Notes	Part Number	US product code	Description	Quantity
Products for Power Circuit				
MMS	1SAM350000R1009	MS132-6.3	MS132-6.3 Manual Motor Starter current range 4.0 - 6.3A	1
MS116/132 Signal/trip alarm, 1NO/1	1SAM201903R1001	SK1-11	SK1-11	1
Type e term. spacer up to MS132-10	1SAM301911R1001	TS1-M3-S1	TS1-M3-S1	1
Close coupler AF09-16/MS116/132	1SBN081306T1000	BEA16-4	BEA16-4	1
Contactor	1SBL137082R1122	AFS09-30-22-11	AFS09-30-22-11 20...60V DC / 24...60V AC Contactor	2
PI side MNT AUX 1NO1NC AF09K-96K/NF	1SBN010120R1011	CAL4-11	CAL4-11 Auxiliary Contact Block	1
3P SW 20A NF N1 safety switch (near motor)	1SCA022823R6630	EOT16U3M1-S	EOT16U3M1-S	1
Products for control Circuit				
Main Incomer MCCB	1SDA074695R1	XT1HU3020AFF000XXX	XT1H 125 TMF 20-500 3P F F UL/CSA	1
CM-MSS.13S Thermistor relay	1SVR730740R0300	1SVR730740R0300	CM-TCS.13S Temperature monitoring relay Temp.-range 0...+200°C, 24-240VAC/DC	1
CM-MPS.53S Three-phase mon.	1SVR750487R8300	1SVR750487R8300	CM-MPN.52S Three-phase monitoring relay 2c/o, 0,0.1-30s, L1-L2-L3=3x350-580VAC	1
E90 class CC FH 3P 30A for voltage monitoring relay	2CSM299932R1801	E93/30CC	E93/30CC	2
Fuse, type CC, 600V, 6A for power supply	Not provided by ABB. Example: Bussmann KTK-R-2, LP-CC-2			3
Fuse, type CC, 600V, 1A for voltage monitoring relay	Not provided by ABB. Example: Bussmann KTK-R-2, LP-CC-2			3
CP-T 24/5.0 power supply 500 V max	1SVR427054R0000	1SVR427054R0000	CP-T 24/5.0	1
MCB for power supply output DC voltage side	2CDS271335R0064	ST201M-C6NA	ST201M-C6NA Miniature Circuit Breaker - 2P - C - 6 A	1
Products for safety Circuit				
Sentry SSR10 24VDC	2TLA010050R0000	2TLA010050R0000	Sentry SSR10 Safety relay	1
INCA 1 type ABB	2TLA030054R0100	2TLA030054R0100	INCA 1 Emergency stop button	2
Linestrong2, 2NC/2NO, NPT LED	2TLA050202R0332	2TLA050202R0332	LineStrong2 - up to 80m	1
Accessory for Linestrong	2TLA050210R0520	2TLA050210R0520	Accessory 50m stainless steel rope pull kit with Allen Key	1
EstrongZ Estop 2NC/2NO M20 SS LED	2TLA050220R1222	2TLA050220R1222	Estrongz - Emergency Stop with 2 NC/2 NO, 1/2 NPT threads, SS, 24VDC LED	1

Continue →

Product Notes	Part Number	US product code	Description	Quantity
Products for command and signalling				
Interface relay 2 c/o	1SVR405601R1000	1SVR405601R1000	CR-P024DC2	1
Interface relay - socket	1SVR405650R1000	1SVR405650R1000	CR-PSS	1
Modular Plastic 40mm TW-REL RED, 1 NO & 1 NC	1SFA611523R1001	MPET4-10R	MPET4-10R Emergency Stop	1
Modular Plastic selectr 2 pos. maint. Black 1NO+1NC	1SFA611201R1006	M2SS2-10B	M2SS2-10B Selector Switch	1
Modular flush PB MOM. Green, 1NO	1SFA611100R1002	MP1-10G	MP1-10G Pushbutton	1
Modular flush PB MOM. RED 1NC	1SFA611100R1001	MP1-10R	MP1-10R Pushbutton	1
3 position holder for Modular plastic	1SFA611605R1100	MCBH-00	MCBH-00 Contact Block Holder	4
Modular NO contact Block	1SFA611610R1001	MCB-10	MCB-10 Contact Block	3
Modular NC contact Block	1SFA611610R1010	MCB-01	MCB-01 Contact Block	3
Pilot light CL2 Red 24V AC/DC	1SFA619403R5021	CL2-502R	CL2-502R	1
Pilot light CL2 Green 24V AC/DC	1SFA619403R5022	CL2-502G	CL2-502G	1
Pilot light CL2 Yellow 24V AC/DC	1SFA619403R5023	CL2-502Y	CL2-502Y	1
Blink 24V A/D INTG LED Red	1SFA616070R3061	KL70-306R	KL70-306R	1
Blink 24V A/D INTG LED Green	1SFA616070R3062	KL70-306G	KL70-306G	1
Blink 24V A/D INTG LED Yellow	1SFA616070R3063	KL70-306Y	KL70-306Y	1
Light stack audible module, 24VAC	1SFA616071R3001	KB70-3001	KB70-3001	1
Stacklight,contact box,side EX	1SFA616077R1001	KA70-1001	KA70-1001	1
Base with integrated tube	1SFA616077R1011	KA70-1011	KA70-1011	1
For tube mounting, including cap	1SFA616075R1001	KT70-1001	KT70-1001	1
Accessories for pilot devices	SK615550-44	SK 615 550-44	Legend plate "Start", 22mm	1
Accessories for pilot devices	SK615552-21	SK 615 552-21	Legend plate "Off", 22mm	1
Accessories for pilot devices	SK615552-22	SK 615 552-22	Legend plate "On", 22mm	1
Accessories for pilot devices	SK615552-31	SK 615 552-31	Legend plate "Stop", 22mm	1
Accessories for pilot devices	1SFA619930R1026	CA6-1026	Legend plate, black on yellow aluminum, "Emergency stop"	2

Note: Feeder circuit breaker rating may change if additional loads are connected

Key benefits of offered products

Reliable in all networks

The electronic system within the AF contactor continuously monitors the current and voltage applied to the coil. The contactor is safely operated in an always-optimized, hum-free condition



Wide control voltage range

The AF contactor ensures steady operation in unstable networks and signifies a major advancement in motor control and power switching, with no threat of voltage sags, dips, or surges. Prevents stoppages caused by voltage fluctuations.

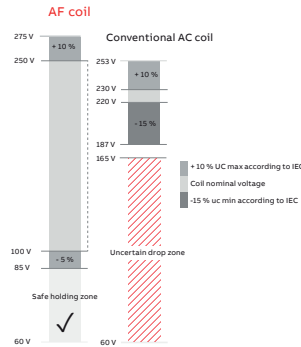

AC & DC control voltage

Thanks to AF technology, the same contactor can be used for both AC and DC control. This makes it easier to choose the type of contactor and reduces the number of parts to keep in stock.

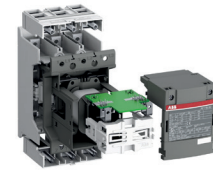

Reduced coil consumption

Thanks to AF technology contactor coil consumption is reduced by 80%, thus less heat dissipation and reduced temperature rise. This allows increased installation density in the panel, reduced control transformer rating, reduced control panel footprint and cost savings.

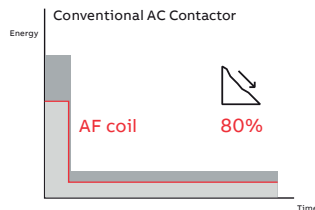

Built-in Surge suppressor

Conventional contactor technology normally requires an external surge suppressor. With AF contactor technology, surges are handled by a built-in contactor and never reach the control circuit. One less product required and no need to worry about complications causing electronics near contactors to fail.



Busbar connectors for group assembly

Three-phase busbars ensure rapid, safe connection and are therefore a cost-effective solution. In addition, up to 5 manual motor starters can be fitted next to each other with optional spacing for auxiliary contacts.

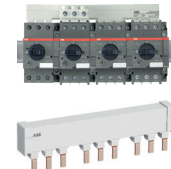

Harmonized range of accessories

MMS up to 80 A share the same main accessories like auxiliary contacts, signaling contacts, shunt trips and undervoltage releases. This significantly reduces the part list and makes selection of the right accessories easy.

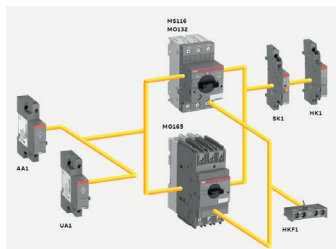

Easy to connect

Save wiring time and avoid mistakes by using a connecting link between ABB manual motor starters and soft starters or contactors. This creates harmonious and compact starter combinations that are easy to mount.



Troubleshooting made easy

Separate thermal and magnetic trip indication makes troubleshooting a lot easier and faster and reduces downtime. This allows you to easily take action based on thermal or magnetic tripping.

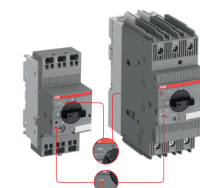

Key benefits of offered products

Motor heating option in softstarters

Keep your motor running reliably even in cold and damp environments.

- Removes condensation from idle motors.
- Prevents the motor from freezing.
- Perfect for damp installations and cold environments.



Detachable keypad

Control your process and softstarter safely. The detachable keypad makes safe installation possible and there is no need to buy accessories, thus cost savings for the customer.

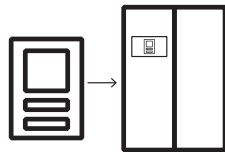

Limp mode in softstarter

Plan stops for increased productivity.

- Keep running even when one thyristor has shorted.
- Service your plant when you have the time.
- Protections and main features continue to function.

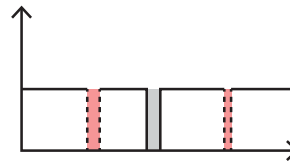

Coated PCBA

Longer lifetime and enhanced reliability for your Softstarter, thereby reducing the risk of unwanted stops. This is a **standard feature for PSE and PSTX**, so there is no risk of ordering a unit without coated PCBAs and no additional cost.



PT100 input for motor protection

The Softstarter has a **3-wire PT100** input. The trip temperature is set by the user. The highest trip temperature is 250° while the lowest is -25°. **PT100 measurement accuracy** must be +/- 3° with 3 wires measuring if the 3 connecting cables have the same resistance.



Flexible soft logic possible with UMC100.3

Flexible in creating the soft logic for switching ON the motor based on temperature monitoring input.

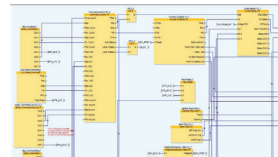

LEDs and display for sentry safety relay

LEDs allow for more status messages and simplify troubleshooting. Models with displays offer preset configurations and extensive fault information on both safety sentry relay and Pluto controller.

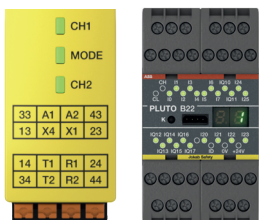

Detachable terminal blocks for sentry safety relay

Detachable terminal blocks speed up connection and replacement both in sentry safety relay & pluto controller. No tools are required for connecting a cable in the push-in style terminals. Just use the cable to push into the opening in the sentry safety relay.



Communication with external networks

Pluto gateways provide a two-way, non-safe communication between the Pluto safety bus and other field buses. This is mainly used to exchange information between the safety system and the other systems.



Easy programming - Pluto Manager

Ready-made TÜV approved blocks for safety functions make it easy to reach PL e/SIL3. More advanced functions can be designed and complete machines controlled thanks to ladder logic and text programming.



LED diagnostics for emergency stops

Models with integrated LED diagnostics help reduce downtime when troubleshooting since the visual status is easily seen from a distance.



Functional safety design tool - FSDT-01

This tool supports both standards: EN ISO 13849-1:2015 and IEC 62061 ed.1.2 (2015). It has been created to simplify the process of safety function design and verification, and to generate documentation to support compliance with the requirements laid down by the aforementioned standards and the European Directives on safety.



Pull wire emergency stop switch

Simplifies cable tensioning and adjustment. Tension to mid-position as indicated by the green arrows in the viewing window of each switch.



Product offering



Contactors:



 WEB PAGE
 CATALOG

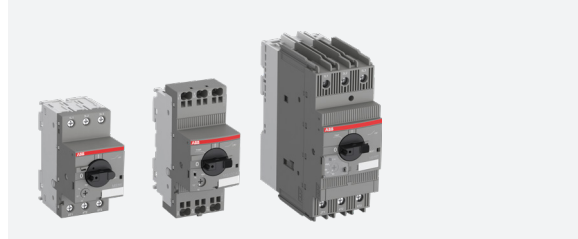

Manual motor starters:

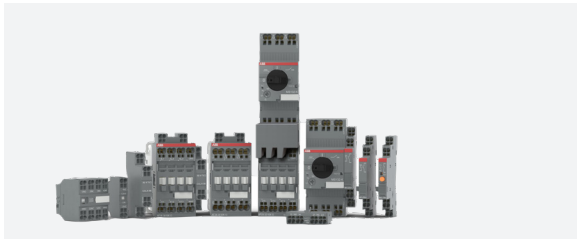

 WEB PAGE
 CATALOG

Push-In Spring Motor Starting solution:



 WEB PAGE
 CATALOG



Softstarters:



 WEB PAGE
 CATALOG



Electronic compact starter:



 WEB PAGE
 CATALOG



Intelligent Motor controller UMC100.3:



 WEB PAGE
 CATALOG



Three phase monitoring relays:

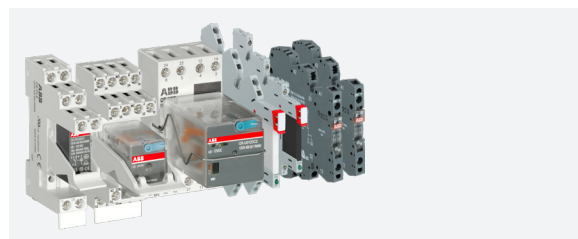

 WEB PAGE
 CATALOG

Pluggable Interface Relays:



 WEB PAGE
 CATALOG

Primary switched mode power supplies:



 WEB PAGE
 CATALOG

Time relays:



 WEB PAGE
 CATALOG

Temperature monitoring relay:

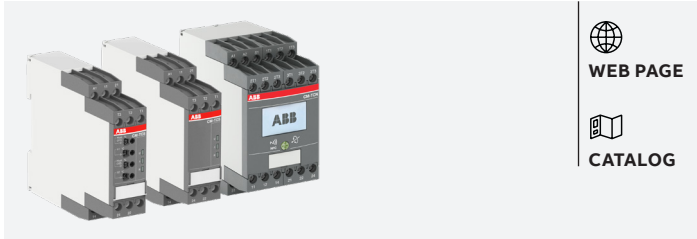

 WEB PAGE
 CATALOG

Tmax XT:



 WEB PAGE
 CATALOG

Switch Fuse Units & Switch Disconnectors:



 WEB PAGE
 CATALOG

Safety relays:



 WEB PAGE
 CATALOG

System pro M compact - MCB:



 WEB PAGE
 CATALOG

Pilot devices:

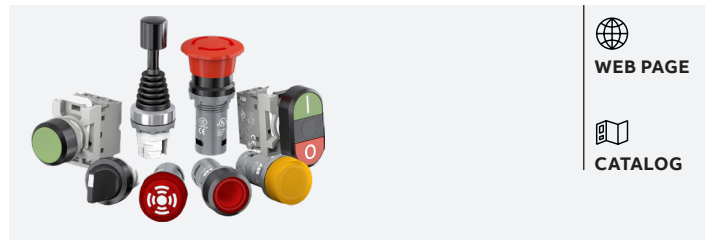

 WEB PAGE
 CATALOG

Enclosed safety switch:

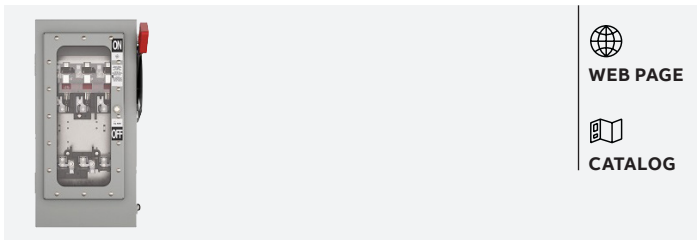

 WEB PAGE
 CATALOG

Enclosed safety switch (EOT series):



 WEB PAGE
 CATALOG

Pluto Safety controller:



 WEB PAGE
 CATALOG

Optical safety devices (Light curtain):

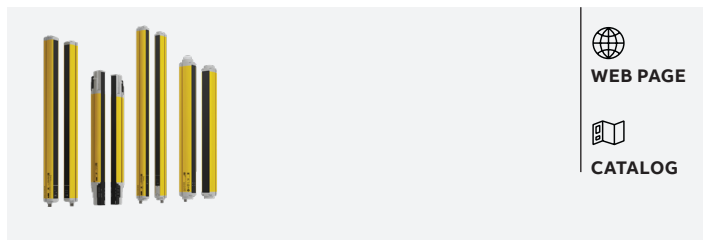

 WEB PAGE
 CATALOG

Functional safety design tool:



 WEB PAGE
 CATALOG



Emergency stop:



 WEB PAGE
 CATALOG

Safety sensors, switches and locks:



 WEB PAGE
 CATALOG



ABB Ability™ Energy and Asset Manager
is a state-of-the-art cloud solution that integrates energy and asset management in a single intuitive dashboard.

[Discover more](#)

[Rate this document](#)



ABB S.p.A.
Electrification Business Area
Smart Power Division
5, Via Pescaria
I-24123 Bergamo - Italy
Phone: +39 035 395.111

new.abb.com/low-voltage

We reserve the right to make technical changes and modify the contents of this document without prior notice. With regard to purchase orders, the agreed particulars shall prevail. ABB AG declines all and every liability for potential errors or possible lack of information in this document.

We reserve all rights to this document and to the subject matter and illustrations contained therein. All reproduction, disclosure to third parties or utilization of these contents – in whole or in part – is forbidden without the prior written consent of ABB AG. Copyright © 2022 ABB
All rights reserved