



WTB26I-24161120A00

W26

COMPACT PHOTOELECTRIC SENSORS

SICK
Sensor Intelligence.



Illustration may differ

Ordering information

Type	Part no.
WTB26I-24161120A00	1218667

Other models and accessories → www.sick.com/W26



Detailed technical data

Features

Device type	Photoelectric sensors
Sensor/ detection principle	Photoelectric proximity sensor, Background suppression
Dimensions (W x H x D)	24.6 mm x 82.5 mm x 53.3 mm
Housing design (light emission)	Rectangular
Sensing range max.	30 mm ... 2,000 mm ¹⁾
Type of light	Infrared light
Light source	LED ²⁾
Light spot size (distance)	Ø 14 mm (1,000 mm)
Wave length	850 nm
Adjustment	
Teach-Turn adjustment	BluePilot: For setting the sensing range
IO-Link	For configuring the sensor parameters and Smart Task functions
Indication	
LED blue	BluePilot: sensing range indicator
LED green	Operating indicator Static: power on Flashing: IO-Link mode
LED yellow	Status of received light beam

¹⁾ Object with 90 % reflectance (referred to standard white, DIN 5033).

²⁾ Average service life: 100,000 h at T_J = +25 °C.

	Static on: object present Static off: object not present
Pin 2 configuration	External Input (test), Teach-in, switching signal

¹⁾ Object with 90 % reflectance (referred to standard white, DIN 5033).

²⁾ Average service life: 100,000 h at T_U = +25 °C.

Mechanics/electronics

Supply voltage	10 V DC ... 30 V DC ¹⁾
Ripple	< 5 V _{pp}
Current consumption	30 mA ²⁾ 50 mA ³⁾
Switching output	Push-pull: PNP/NPN
Output: Q_{L1} / C	Switching output or IO-Link mode
Output function	Factory setting: Pin 2 / white (MF): NPN normally open (light switching), PNP normally closed (dark switching), Pin 4 / black (QL1 / C): NPN normally closed (dark switching), PNP normally open (light switching), IO-Link
Switching mode	Light/dark switching
Signal voltage PNP HIGH/LOW	Approx. V _S - 2.5 V / 0 V
Signal voltage NPN HIGH/LOW	Approx. V _S / < 2.5 V
Output current I_{max.}	≤ 100 mA
Response time	≤ 500 μs ⁴⁾
Switching frequency	1,000 Hz ⁵⁾
Connection type	Male connector M12, 4-pin
Circuit protection	A ⁶⁾ B ⁷⁾ C ⁸⁾ D ⁹⁾
Protection class	III
Weight	80 g
Housing material	Plastic, VISTAL®
Optics material	Plastic, PMMA
Enclosure rating	IP66 (According to EN 60529) IP67 (According to EN 60529) IP69 (According to EN 60529) ¹⁰⁾
Ambient operating temperature	-40 °C ... +60 °C
Ambient temperature, storage	-40 °C ... +75 °C
UL File No.	NRKH.E181493 & NRKH7.E181493

¹⁾ Limit values.

²⁾ 16 V DC ... 30 V DC, without load.

³⁾ 10 V DC ... 16 V DC, without load.

⁴⁾ Signal transit time with resistive load in switching mode. Different values possible in COM2 mode.

⁵⁾ With light/dark ratio 1:1 in switching mode. Different values possible in IO-Link mode.

⁶⁾ A = V_S connections reverse-polarity protected.

⁷⁾ B = inputs and output reverse-polarity protected.

⁸⁾ C = interference suppression.

⁹⁾ D = outputs overcurrent and short-circuit protected.

¹⁰⁾ Replaces IP69K with ISO 20653: 2013-03.

Safety-related parameters

MTTF_D	629 years
DC_{avg}	0 %

Communication interface

Communication interface	IO-Link V1.1
Communication Interface detail	COM2 (38,4 kBaud)
Cycle time	2.3 ms
Process data length	16 Bit
Process data structure	Bit 0 = switching signal Q _{L1} Bit 1 = switching signal Q _{L2} Bit 2 ... 15 = empty
VendorID	26
DeviceID HEX	0x800184
DeviceID DEC	8388996

Smart Task

Smart Task name	Base logics
Logic function	Direct AND OR Window Hysteresis
Timer function	Deactivated On delay Off delay ON and OFF delay Impulse (one shot)
Inverter	Yes
Switching frequency	SIO Direct: 1000 Hz ¹⁾ SIO Logic: 800 Hz ²⁾ IOL: 650 Hz ³⁾
Response time	SIO Direct: 500 μs ¹⁾ SIO Logic: 600 μs ²⁾ IOL: 750 μs ³⁾
Repeatability	SIO Direct: 150 μs ¹⁾ SIO Logic: 300 μs ²⁾ IOL: 400 μs ³⁾
Switching signal	
Switching signal Q _{L1}	Switching output
Switching signal Q _{L2}	Switching output

¹⁾ SIO Direct: sensor operation in standard I/O mode without IO-Link communication and without using internal sensor logic or time parameters (set to "direct"/"deactivated").

²⁾ SIO Logic: Sensor operation in standard I/O mode without IO-Link communication. Sensor-internal logic or timing parameters plus Automation Functions used.

³⁾ IOL: Sensor operation with full IO-Link communication and usage of logic, timing and Automation Function parameters.

Diagnosis

Status information	
Device status	Yes
Quality of teach	Yes

Classifications

ECl@ss 5.0	27270904
ECl@ss 5.1.4	27270904
ECl@ss 6.0	27270904
ECl@ss 6.2	27270904
ECl@ss 7.0	27270904
ECl@ss 8.0	27270904
ECl@ss 8.1	27270904
ECl@ss 9.0	27270904
ECl@ss 10.0	27270904
ECl@ss 11.0	27270904
ETIM 5.0	EC002719
ETIM 6.0	EC002719
ETIM 7.0	EC002719
ETIM 8.0	EC002719
UNSPSC 16.0901	39121528

Connection diagram

Cd-390

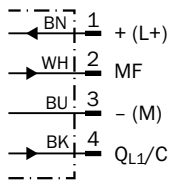

Characteristic curve

WTB26I-xxxxx1xx

Minimum distance in mm (y) between the set sensing range and background (white, 90%)

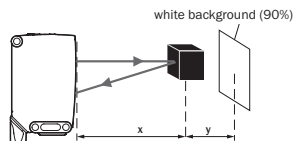
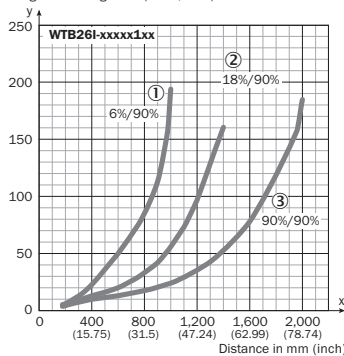

Example:
 Sensing range on black, 6%,
 x = 800 mm, y = 85 mm

- ① Sensing range on black, 6% remission
- ② Sensing range on gray, 18% remission
- ③ Sensing range on white, 90% remission

Light spot size

WTB26I-xxxxx1xx

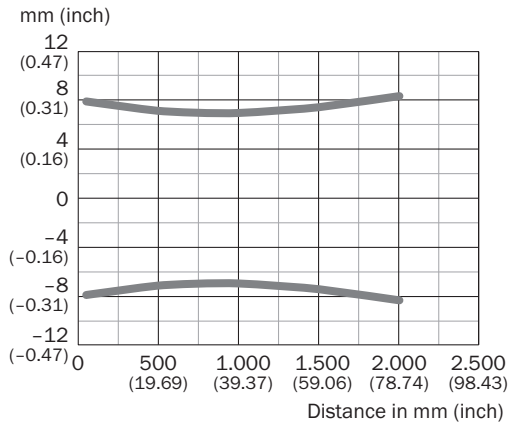

Sensing range diagram

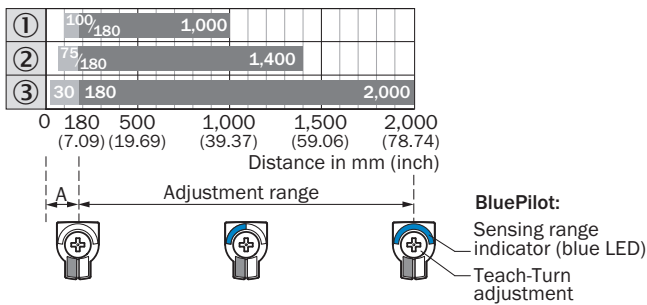

A = Detection distance (depending on object remission)

- ① Sensing range on black, 6% remission
- ② Sensing range on gray, 18 % remission
- ③ Sensing range on white, 90% remission

Adjustments

Display and adjustment elements

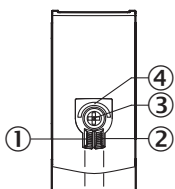

- ① LED indicator green
- ② LED indicator yellow
- ③ Teach-Turn adjustment
- ④ LED blue

Dimensional drawing (Dimensions in mm (inch))

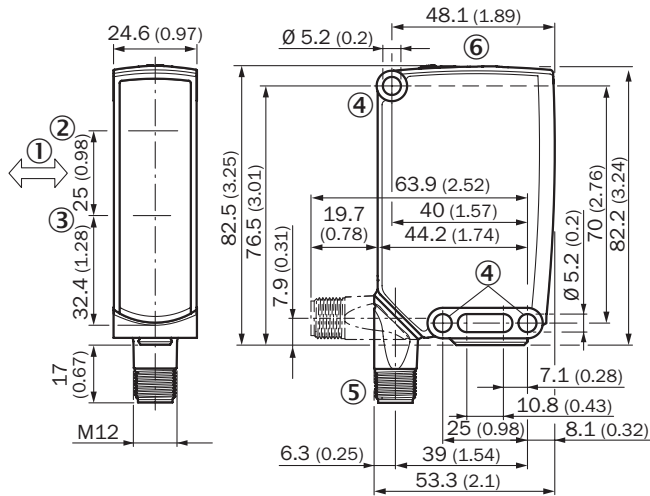

WTB26, WTL26, WTF26, connector



- ① Standard direction of the material being detected
- ② Center of optical axis, sender
- ③ Center of optical axis, receiver
- ④ Mounting hole, \varnothing 5.2 mm
- ⑤ Connection
- ⑥ Display and adjustment elements

Recommended accessories

Other models and accessories → www.sick.com/W26

	Brief description	Type	Part no.
Universal bar clamp systems			
	Plate N12 for universal clamp. For mounting PL30A, P250 reflectors, W27 and WTR2 sensors., Zinc plated steel (sheet), Zinc die cast (clamping bracket), Universal clamp (2022726), mounting hardware	BEF-KHS-N12	2071950
Plug connectors and cables			
	Head A: female connector, M12, 4-pin, straight, A-coded Head B: Flying leads Cable: Sensor/actuator cable, PVC, unshielded, 5 m	YF2A14-050VB3XLEAX	2096235
	Head A: male connector, M12, 4-pin, straight Head B: - Cable: unshielded	STE-1204-G	6009932

Recommended services

Additional services → www.sick.com/W26

	Type	Part no.
Function Block Factory		
<ul style="list-style-type: none">Description: The Function Block Factory supports common programmable logic controllers (PLCs) from various manufacturers, such as Siemens, Beckhoff, Rockwell Automation and B&R. More information on the FBF can be found here.	Function Block Factory	On request

SICK AT A GLANCE

SICK is one of the leading manufacturers of intelligent sensors and sensor solutions for industrial applications. A unique range of products and services creates the perfect basis for controlling processes securely and efficiently, protecting individuals from accidents and preventing damage to the environment.

We have extensive experience in a wide range of industries and understand their processes and requirements. With intelligent sensors, we can deliver exactly what our customers need. In application centers in Europe, Asia and North America, system solutions are tested and optimized in accordance with customer specifications. All this makes us a reliable supplier and development partner.

Comprehensive services complete our offering: SICK LifeTime Services provide support throughout the machine life cycle and ensure safety and productivity.

For us, that is “Sensor Intelligence.”

WORLDWIDE PRESENCE:

Contacts and other locations –www.sick.com