



ELWIKA 5012 PG7

Circular Connectors E-series M12/FIXCON:with screw locking:Angled cable socket, self-assembled

Product description

Description	Angled cable socket, unassembled, strain relief by means of clamping cage
Type	ELWIKA 5012 PG7
Order No.	933 175-100
Type of contact	female
Number of contacts	5
Cable gland	PG 7
Conductor size	max. 0.75 mm ²
Standard	IEC 61076-2-101 (Ed. 1)/ IEC 60947-5-2
Housing Color	black

Drawing

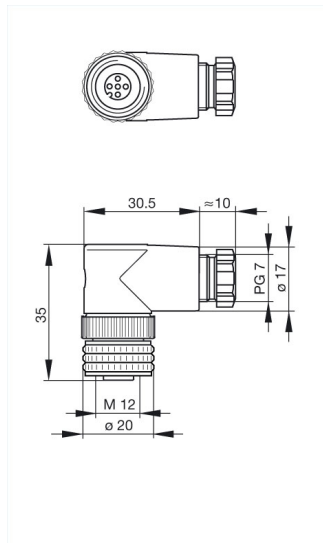

Technical data

Rated voltage	50 V AC/DC
Rated current	4 A
Type of termination	screw
Suitable cables	diameter 4 mm to 6 mm

Material

Contact material	Cu Zn
Contact surface material	Sn
Contact bearer material	PA
Housing material	PA
Coupling nut material	Zn Al/Ni
O-Ring	NBR

Environmental conditions

Protection class (IEC 60529)	IP 67
Pollution severity	3
Temperature range	-25 °C to +90 °C
Inflammability class	
Housing	94 V-2
Contact bearer	94 V-2
Approvals	
UL	UL pending
Packaging unit	
Packaging unit	100 pieces
Scope of delivery and accessories	
Accessories to order separately	protective cap M12 VS, order no. 734 209-100