

# Antistatic One-touch Fittings

Applicable Tubing: Metric Size/Connection Thread: M, Rc, G, NPT, NPTF

## Series KA

RoHS

One-touch fitting with antistatic prevention.

One-touch IN/OUT connection.

Possible to use from vacuum (-100 kPa).

Can be used in copper-free application.

Flame resistance (Equivalent to UL-94 standard, material V-0)

Surface resistance  $10^4$  to  $10^7 \Omega$

Conductive resin is used for body and seals in fittings and tubing.



### Principal Parts Material

Body	C3604, PBT
Stud	C3604
Chuck	Stainless steel 304
Guide	Stainless steel 304, C3604, PBT
Collet, Release button	PBT
Seal, O-ring	NBR
Gasket	Stainless steel 304, NBR

- C3604 is all electroless nickel plated.
- PBT parts have conductive ( $10^4$  to  $10^7 \Omega$ ) and flame resistant applications. (UL-94 standard, V-0)
- Conductive NBR ( $10^4$  to  $10^7 \Omega$ ) is used for seals.

### Gasket (Thread portion)

Model M-5G2 (For M5 thread)  
M-6G (For M6 thread)  
KQG-U□□ (For Uni thread)

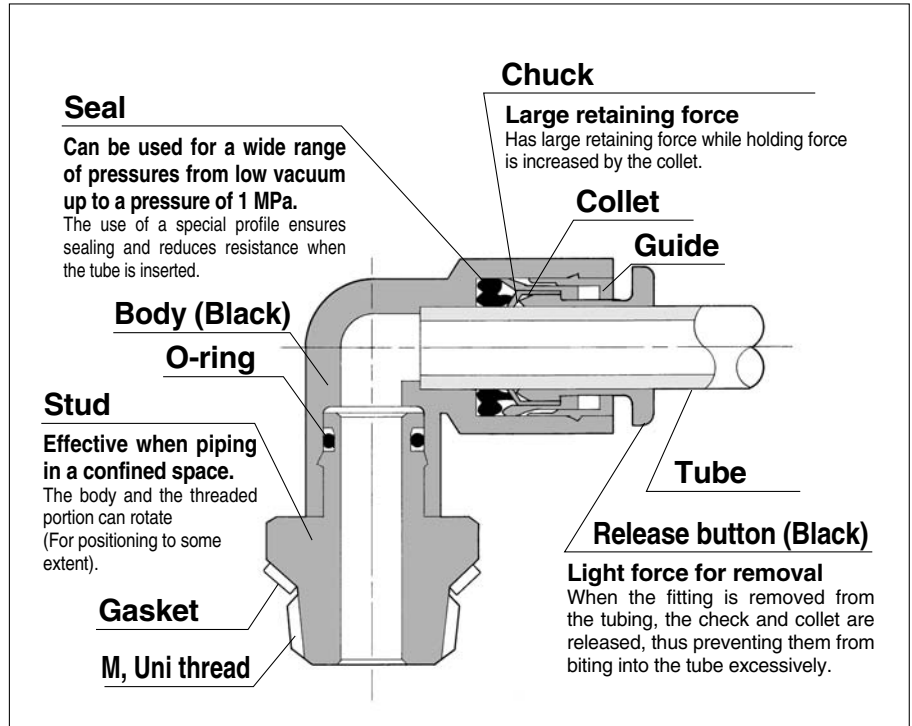

### Applicable Tubing

Tubing material	Antistatic soft nylon, Antistatic polyurethane
Tubing O.D.	ø3.2, ø4, ø6, ø8, ø10, ø12

### Specifications

Fluid	Air
Operating pressure range	-100kPa to 1MPa
Proof pressure	3MPa
Ambient and fluid temperature	0 to 40°C
Thread	Uni thread JIS B 0209 (Metric coarse thread)
Seal (Thread portion)	Gasket
Copper-free	Brass parts are all electroless nickel plated.
Surface resistance	$10^4$ to $10^7 \Omega$

### How to Order Gasket for Uni Thread







**KQG-U01**

Gasket for Uni thread

Applicable port size

U01	Uni 1/8
U02	Uni 1/4
U03	Uni 3/8
U04	Uni 1/2

## Male Connector: KAH

<M5, M6>	Applicable tubing O.D. (mm)	Connection thread M thread Uni thread	Model	H (width across flats)	øD	L	A*	M	Effective area (mm <sup>2</sup> )		Mass (g)	
									Soft nylon	Urethane		
	3.2	M5 x 0.8	KAH23-M5	7	8.5	17	14	13	3.4	2.9	2.1	
		M6 x 1	KAH23-M6	8		17.5						
		1/8	KAH23-U01	10		12.5						8.5
	4	M5 x 0.8	KAH04-M5	8	9.5	17	14	13	4	4	2	
		M6 x 1	KAH04-M6	8		17.5						
		1/8	KAH04-U01	10		18.5						13.5
		1/4	KAH04-U02	14		16.5						10.5
	6	M5 x 0.8	KAH06-M5	10	11.5	18.5	15	14	4	4	3	
		M6 x 1	KAH06-M6	10		19						
		1/8	KAH06-U01	12		19.5						14.5
		1/4	KAH06-U02	14		13						17
	8	1/8	KAH08-U01	14	14	25	20.5	18.5	18.0	18.0	11	
		1/4	KAH08-U02	14		21.5						15.5
		3/8	KAH08-U03	17		19.5						13.5
	10	1/8	KAH10-U01	17	17	28	23	21	29.5	29.5	17	
		1/4	KAH10-U02	17		24						18
		3/8	KAH10-U03	17		22						14
		1/2	KAH10-U04	22		22						14
	12	1/4	KAH12-U02	19	19	30.5	24.5	22	46.1	46.1	22	
		3/8	KAH12-U03	19		25.5						19.5
		1/2	KAH12-U04	22		24.5						16.5
		1/2	KAH12-U04	22		24.5						16.5

\* Reference dimensions after Uni thread installation.

<M5, M6>

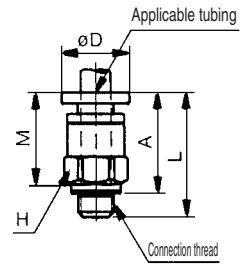



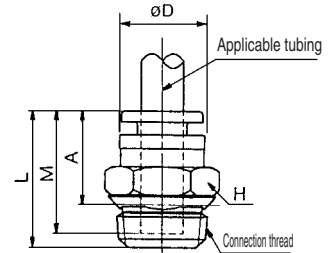

<Uni thread>



- K
- M
- H
- KK
- D
- MS
- LQ
- MQR
- T

## Male Elbow: KAL

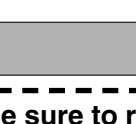
<M5, M6>	Applicable tubing O.D. (mm)	Connection thread M thread Uni thread	Model	H (width across flats)	øD1	øD2	L1	L2	A*	M	Effective area (mm <sup>2</sup> )		Mass (g)	
											Soft nylon	Urethane		
	3.2	M5 x 0.8	KAL23-M5	8	9.6	8	17.5	15	16	15.5	3.4	2.9	6	
		M6 x 1	KAL23-M6	8				15.5						
		1/8	KAL23-U01	10				19.5						21
	4	M5 x 0.8	KAL04-M5	8	10.4	8	18	15.5	16	16	3.5	3.5	4	
		M6 x 1	KAL04-M6	8				16						
		1/8	KAL04-U01	10				20						20.5
		1/4	KAL04-U02	14				22						21.5
	6	M5 x 0.8	KAL06-M5	8	12.8	8	20	16	18	17	3.5	3.5	6	
		M6 x 1	KAL06-M6	8				16.5						
		1/8	KAL06-U01	10				21.5						23.5
		1/4	KAL06-U02	14				23						24.5
	8	1/8	KAL08-U01	12	15.2	12	23	22.5	25.5	18.5	14.9	14.9	11	
		1/4	KAL08-U02	14				24.5						26
		3/8	KAL08-U03	17				25.5						27
	10	1/8	KAL10-U01	17	18.5	17	26.5	25	29.5	21	14.9	14.9	24	
		1/4	KAL10-U02	17				26.5						30
		3/8	KAL10-U03	17				27						30.5
		1/2	KAL10-U04	22				30						31.5
	12	1/4	KAL12-U02	17	20.9	17	28.5	27	31.5	22	39.7	39.7	27	
		3/8	KAL12-U03	17				28						32.5
		1/2	KAL12-U04	22				31						33.5

\* Reference dimensions after Uni thread installation.

<M5, M6>

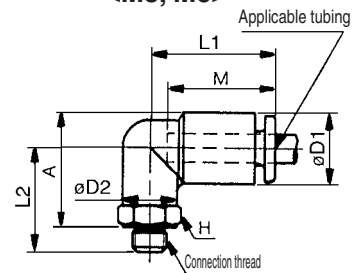

<Uni thread>

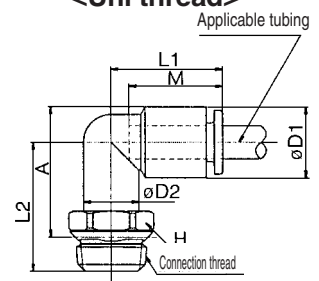

## ⚠ Precautions

**Be sure to read before handling.**  
**Refer to front matters 58 and 59 for Safety Instructions and pages 13 to 16 for Fittings and Tubing Precautions.**

### ⚠ Caution

- Female thread portion connected with fitting must be grounded, otherwise static electricity will remain in the fittings and tubes.

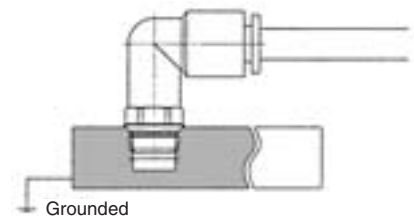

# Series KA

## Male Branch Tee: KAT

<M5, M6>	Applicable tubing O.D. (mm)	Connection thread M thread Uni thread	Model	H (width across flats)	øD1	øD2	L1	L2	A*	M	Effective area (mm <sup>2</sup> )		Mass (g)	
											Soft nylon	Urethane		
	3.2	M5 x 0.8	KAT23-M5	8	9.6	8	17.5	15	16	15.5	3.4	2.9	8	
		M6 x 1	KAT23-M6	10				15.5						19.5
		1/8	KAT23-U01	10				19.5						21
<b>&lt;Uni thread&gt;</b>	4	M5 x 0.8	KAT04-M5	8	10.4	8	18	15.5	16	16	4.3	4.3	6	
		M6 x 1	KAT04-M6	10				16						20
		1/8	KAT04-U01	10				20						21.5
		1/4	KAT04-U02	14				22						24.5
6	6	M5 x 0.8	KAT06-M5	8	12.8	8	20	16	17	17	4.3	4.3	7	
		M6 x 1	KAT06-M6	10				16.5						21.5
		1/8	KAT06-U01	10				21.5						23.5
		1/4	KAT06-U02	14				23						24.5
8	8	1/8	KAT08-U01	12	15.2	12	23	22.5	18.5	18.2	18.2	14		
		1/4	KAT08-U02	14				24.5					27	
		3/8	KAT08-U03	17				25.5					27	
10	10	1/8	KAT10-U01	12	18.5	17	26.5	25	21	29.0	29.0	30		
		1/4	KAT10-U02	17				26.5					30	
		3/8	KAT10-U03	17				27					30.5	
		1/2	KAT10-U04	22				30					31.5	
12	12	1/4	KAT12-U02	17	20.9	17	28.5	27	22	45.2	45.2	31		
		3/8	KAT12-U03	17				28					32.5	
		1/2	KAT12-U04	22				31					33.5	

\* Reference dimensions after Uni thread installation.

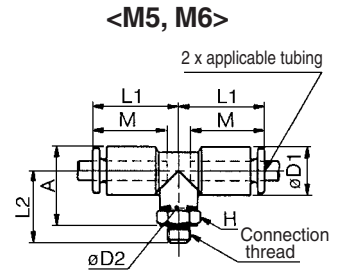

### <Uni thread>

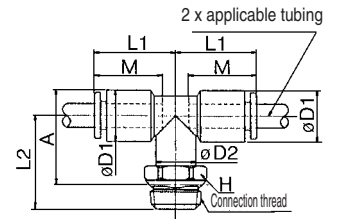

## Male Run Tee: KAY

<M5, M6>	Applicable tubing O.D. (mm)	Connection thread M thread Uni thread	Model	H (width across flats)	øD1	øD2	L1	L2	A*	M	Effective area (mm <sup>2</sup> )		Mass (g)	
											Soft nylon	Urethane		
	3.2	M5 x 0.8	KAY23-M5	8	9.6	8	17.5	15	28.5	15.5	3.4	2.9	8	
		M6 x 1	KAY23-M6	10				15.5						19.5
		1/8	KAY23-U01	10				19.5						33
<b>&lt;Uni thread&gt;</b>	4	M5 x 0.8	KAY04-M5	8	10.4	8	18	15.5	16	16	4.6	4.6	6	
		M6 x 1	KAY04-M6	10				16						20
		1/8	KAY04-U01	10				20						34
		1/4	KAY04-U02	14				22						34.5
6	6	M5 x 0.8	KAY06-M5	8	12.8	8	20	16	17	17	4.6	4.6	7	
		M6 x 1	KAY06-M6	10				16.5						21.5
		1/8	KAY06-U01	10				21.5						37.5
		1/4	KAY06-U02	14				23						37
8	8	1/8	KAY08-U01	12	15.2	12	23	22.5	18.5	17.7	17.7	14		
		1/4	KAY08-U02	14				24.5					41.5	
		3/8	KAY08-U03	17				25.5					42.5	
10	10	1/8	KAY10-U01	12	18.5	17	26.5	25	21	28.4	28.4	30		
		1/4	KAY10-U02	17				26.5					47.5	
		3/8	KAY10-U03	17				27					48	
		1/2	KAY10-U04	22				30					49	
12	12	1/4	KAY12-U02	17	20.9	17	28.5	27	22	45.4	45.4	31		
		3/8	KAY12-U03	17				28					50.5	
		1/2	KAY12-U04	22				31					51.5	

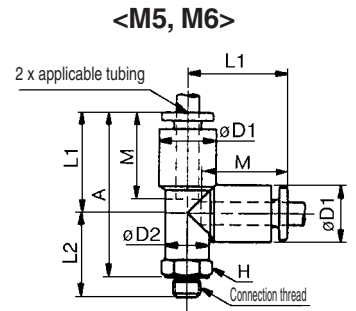

\* Reference dimensions after Uni thread installation.

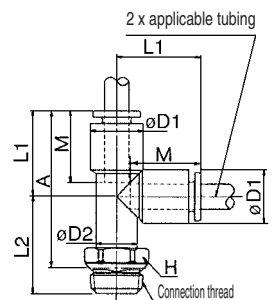

### <Uni thread>



## Branch "Y": KAU

	Applicable tubing O.D. (mm)	Connection thread M thread Uni thread	Model	H (width across flats)	øD	L	P	A*	M	Effective area (mm <sup>2</sup> )		Mass (g)	
										Soft nylon	Urethane		
<b>&lt;M5, M6&gt;</b> 	3.2	M5 x 0.8	<b>KAU23-M5</b>	10	9.6	38	9.6	34.5	15.5	2.2	2.2	9	
		M6 x 1	<b>KAU23-M6</b>	11		38.5				3.4	2.9	11	
		1/8	<b>KAU23-U01</b>										
<b>&lt;Uni thread&gt;</b> 	4	M5 x 0.8	<b>KAU04-M5</b>	11	10.4	39.5	10.4	36	16	2.2	2.2	4	
		M6 x 1	<b>KAU04-M6</b>			40				4.2	4.2	10	
		1/8	<b>KAU04-U01</b>										
		1/4	<b>KAU04-U02</b>	14	42								11
6	M5 x 0.8	<b>KAU06-M5</b>	13	12.8	12.8	42.5	39	17	13.4	13.4	2.2	2.2	12
		<b>KAU06-M6</b>				43							
	1/8	<b>KAU06-U01</b>											13
	1/4	<b>KAU06-U02</b>	14	45									17
	3/8	<b>KAU06-U03</b>	17	46									25
8	1/8	<b>KAU08-U01</b>	17	15.2	15.2	50.5	46.5	18.5	17.7	17.7			26
		<b>KAU08-U02</b>				52							
	3/8	<b>KAU08-U03</b>											27
10	1/4	<b>KAU10-U02</b>	19	18.5	18.5	57.5	51.5	21	28.4	28.4			38
		<b>KAU10-U03</b>				59							
	1/2	<b>KAU10-U04</b>	22	59									51
12	1/4	<b>KAU12-U02</b>	22	20.9	20.9	61	55	22	45.4	45.4			53
		<b>KAU12-U03</b>				62.5							

\* Reference dimensions after Uni thread installation.

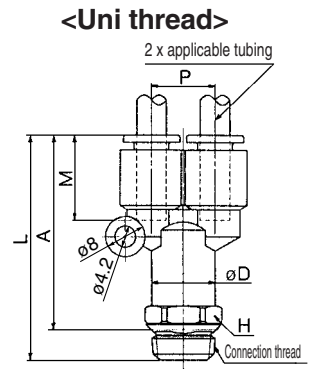
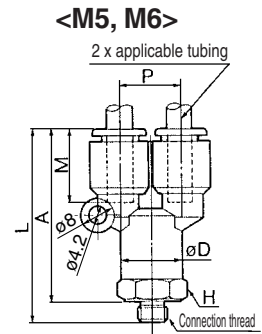

- K
- M
- H
- KK
- D
- MS
- LQ
- MQR
- T

## Straight Union: KAH



Applicable tubing O.D. (mm)	Model	øD	L	M	Effective area (mm <sup>2</sup> )		Mass (g)
					Soft nylon	Urethane	
3.2	<b>KAH23-00</b>	9.6	31.5	15.5	3.4	2.9	3
4	<b>KAH04-00</b>	10.4	32.5	16	5.6	5.6	3
6	<b>KAH06-00</b>	12.8	34.5	17	13.1	13.1	4
8	<b>KAH08-00</b>	15.2	38.5	18.5	18.0	18.0	6
10	<b>KAH10-00</b>	18.5	42.5	21	29.5	29.5	11
12	<b>KAH12-00</b>	20.9	44.5	22	46.1	46.1	14

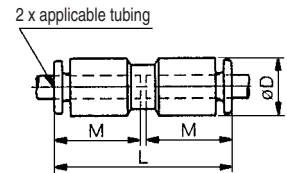

## Different Diameter Straight: KAH



Applicable tubing O.D. (mm)		Model	øD	L	M1	M2	Effective area (mm <sup>2</sup> )		Mass (g)
Ⓐ	Ⓑ						Soft nylon	Urethane	
3.2	4	<b>KAH23-04</b>	10.4	32.5	15.5	16	3.2	2.7	3
4	6	<b>KAH04-06</b>	12.8	34.5	16	17	4.2	4.2	4
6	8	<b>KAH06-08</b>	15.2	38.5	17	18.5	10.7	10.7	6
8	10	<b>KAH08-10</b>	18.5	42	18.5	21	16.7	16.7	11
10	12	<b>KAH10-12</b>	20.9	44.5	21	22	28.2	28.2	14

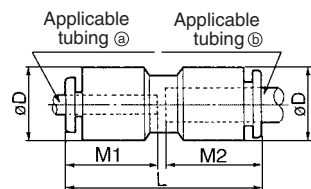

# Series KA

## Union Elbow: KAL



Applicable tubing O.D. (mm)	Model	øD	L	Q	M	Effective area (mm <sup>2</sup> )		Mass (g)
						Soft nylon	Urethane	
3.2	KAL23-00	9.6	17.5	4.3	15.5	3.4	2.9	3
4	KAL04-00	10.4	18	4.5	16	4.2	4.2	6
6	KAL06-00	12.8	20	5.3	17	11.4	11.4	6
8	KAL08-00	15.2	23	6	18.5	14.9	14.9	10
10	KAL10-00	18.5	26.5	6.8	21	25.0	25.0	17
12	KAL12-00	20.9	28.5	7.5	22	39.7	39.7	21

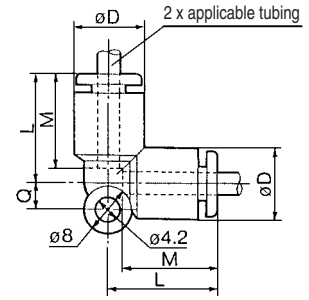

## Union Tee: KAT



Applicable tubing O.D. (mm)	Model	øD	L	Q	M	Effective area (mm <sup>2</sup> )		Mass (g)
						Soft nylon	Urethane	
3.2	KAT23-00	9.6	17.5	4.3	15.5	3.4	2.9	5
4	KAT04-00	10.4	18	4.5	16	6.4	6.9	7
6	KAT06-00	12.8	20	5.3	17	13.4	13.4	10
8	KAT08-00	15.2	23	6	18.5	17.7	17.7	15
10	KAT10-00	18.5	26.5	6.8	21	28.4	28.4	25
12	KAT12-00	20.9	28.5	7.5	22	45.4	45.4	29

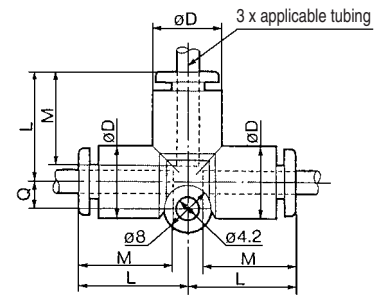

## Union "Y": KAU



Applicable tubing O.D. (mm)	Model	øD	L1	L2	P	Q	M	Effective area (mm <sup>2</sup> )		Mass (g)
								Soft nylon	Urethane	
3.2	KAU23-00	9.6	33	17.5	9.6	9	15.5	3.4	2.9	5
4	KAU04-00	10.4	34	18	10.4	9.7	16	4.2	4.2	7
6	KAU06-00	12.8	37	20	12.8	11.7	17	13.4	13.4	9
8	KAU08-00	15.2	42.5	24.5	15.2	13.7	18.5	17.7	17.7	11
10	KAU10-00	18.5	48	27.5	18.5	16.1	21	28.4	28.4	16
12	KAU12-00	20.9	51	30	20.9	18.1	22	45.4	45.4	23

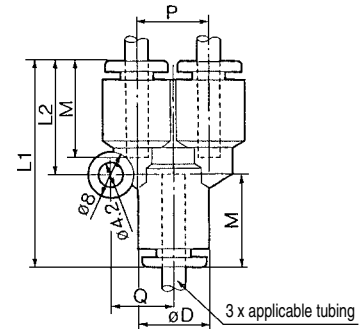

## Plug-in Reducer: KAR



Applicable tubing O.D. (mm)	Applicable fitting size ød	Model	øD	L	A	M	Effective area (mm <sup>2</sup> )		Mass (g)
							Soft nylon	Urethane	
3.2	4	KAR23-04	9.6	33.5	18.5	15.5	3.4	2.9	5
	6	KAR04-06	10.4	34.5	17.5	16	5.6	5.6	1.8
	8	KAR04-08		36.5	18				2.0
10	KAR04-10	39.5	18.5	3.3					
6	8	KAR06-08	12.8	37	18.5	17	13.1	13.1	2.5
	10	KAR06-10		39.5					20
	12	KAR06-12	42	20	4.7				
8	10	KAR08-10	15.2	41	20	18.5	18.0	18.0	4.0
	12	KAR08-12		42					20
10	12	KAR10-12	18.5	44.5	23	21	32.8	32.8	33

