

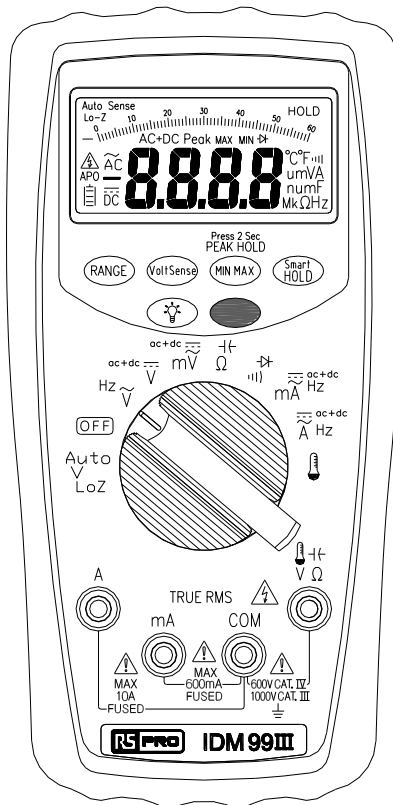

Instruction Manual
IDM 98-III & IDM 99-III
Digital Multimeter

EN



SECTION 1 –SAFETY INFORMATION

Safety Information

Understand and follow operating instructions carefully. Use the instrument only as specified in this manual; otherwise, the protection provided by the instrument may be impaired.

WARNING

Identifies hazardous conditions and actions that could cause **BODILY HARM** or **DEATH**



CAUTION

Identifies conditions and actions that could **DAMAGE** the instrument or equipment under test











WARNING

- Examine the instrument and probes before use. Do not use the instrument if it is wet or damaged
- When using test leads or probes, keep your fingers behind the finger guards.
- Remove the test lead from the instrument before opening the battery cover or instrument case.
- Always use the correct terminals, switch position and range for measurements.
- Never attempt a voltage measurement with the test leads inserted into the "A" input terminals.
- Verify the instrument is operating correctly by measuring a known voltage before use. If in doubt, have the instrument serviced.
- Do not apply more than the rated voltage, as marked on the instrument, between terminals or between any terminal and earth ground.
- Do not attempt a current measurement when the open-circuit voltage is above the fuse protection rating.
- Only replace a fuse with the correct type and rating as specified in this instruction manual.
- Use caution when measuring voltages above 30 Vac rms, 42 Vac peak or 60 Vdc. These voltages pose a shock hazard.
- To avoid false readings that can lead to electric shock, replace the battery as soon as the low battery indicator appears in the display.
- Disconnect the circuit power and discharge all high-voltage capacitors before making resistance, current, continuity, diode or capacitance measurements.
- Do not use the instrument in a hazardous area or around explosive gasses or vapours.
- Wear suitable personal protective equipment when working around or near hazardous live conductors which could be accessible.

CAUTION

- Disconnect the test leads from the test points before changing the position of the function rotary switch.
- Never connect a source of voltage with the function rotary switch in the "Ω", "", "°C", "mA", or "A" position.
- Do not expose the instrument to extremes in temperature or high humidity.
- Never set the instrument in the "Ω", "", "°C", "mA", or "A" position to measure the voltage of a circuit, this could result in damage the instrument and the equipment under test.
- If possible, do not work alone, so assistance can be given if required

The following symbols may appear on the instrument and this instruction manual:

	Risk of electric shock
	See instruction manual
	DC measurement
	Equipment protected by double or reinforced Insulation
	Battery
	Fuse
	Earth
	AC measurement
	Conforms to EU directives
	Dispose of in accordance with local regulations.

Unsafe Voltage

To alert you to the presence of a potentially hazardous voltage, when the instrument detects a voltage ≥ 30 V or a voltage overload (OL) in V, mV . The  symbol is displayed.

Maintenance

Do not attempt to repair this instrument. It contains no user-serviceable parts. Repair or servicing should only be performed by qualified personnel. This instrument should be calibrated yearly, or more frequently if used in harsh conditions or if it is suspected of being inaccurate.

Cleaning

Periodically wipe the case with a dry cloth and detergent.
Do not use abrasives or solvents.

SECTION 2 - METER DESCRIPTION

Instrument Description

Front Panel Illustration

1. LCD display : 6000 counts
2. Push-buttons.
3. Rotary switch for turn the Power On / Off and select the function.
4. Input terminal for "A" (current measurement)
5. Input terminal for "V", " Ω ", " μ C", Hz, and $^{\circ}$ C functions.
6. Common (ground reference) input terminal.
7. Input terminal for mA current measurement.

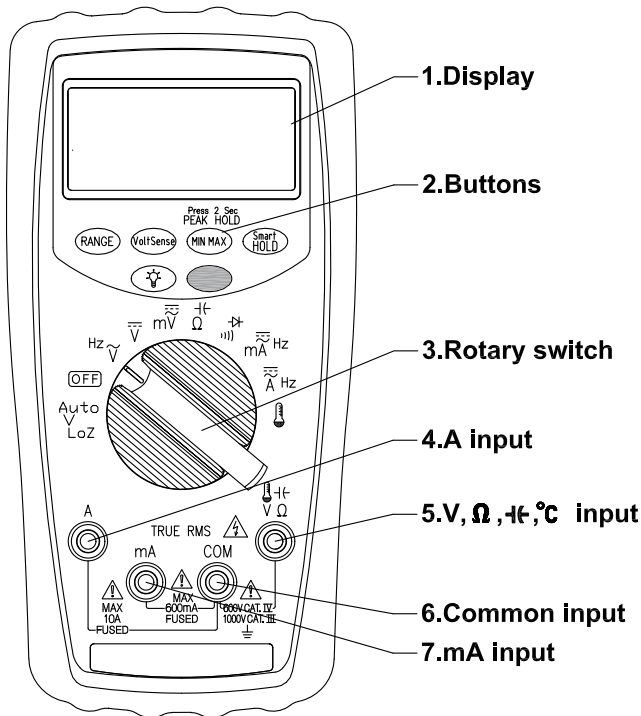

Features

- 6000 count digital display.
- 62 segment bar graph .
- Extra large scale white backlit display
- True RMS
- 0.08% basic DCV accuracy
- Automatic AC/DC Voltage detect with low impedance (Auto-V LoZ)
- VoltSense (Non-contact voltage detection)
- Smart Data Hold
- Peak Hold (1ms) (IDM99-III only)
- Min/ Max function
- AC+DC function
- Frequency counter on AC mode
- Capacitance measurement
- Temperature measurement (IDM99-III only)
- Low battery indicator with segments
- Auto Power Off (20 minutes)
- Shock proof from 4 feet drop
- CAT IV 600V/CAT III 1000V Safety standard

Unpacking and Inspection

Upon removing the instrument from its packaging you should have the following items.

1. IDM98-III or IDM99-III digital multimeter.
2. Test leads set (one black, one red)
3. Temperature probe (IDM99-III only)
4. User manual
5. Protective holster
6. Battery (installed)

SECTION 3 – MEASUREMENTS

Preparation and caution before measurement

Observe all warnings and cautions

When connecting the test leads to the device under test connect the common test lead before connecting the live test lead ; when removing the test leads remove the test live lead before removing the common test lead.

The figures on the following pages show how to make basic measurements.

Measuring AC / DC Voltage

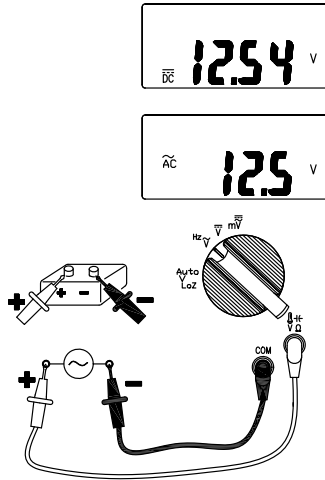

Rotate the switch and press the Function button to select the measuring function.
See "Using the Function Buttons"

Measuring AC/DC Current

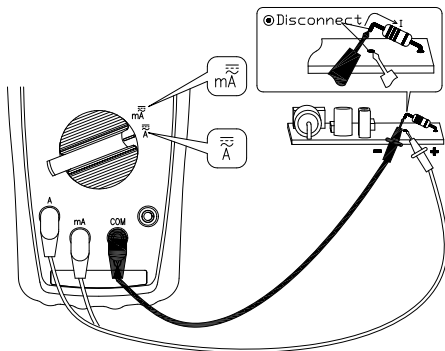

Rotate the switch and press the Function button to select the measuring function.
See "Using the Function Buttons"

Measuring Frequency

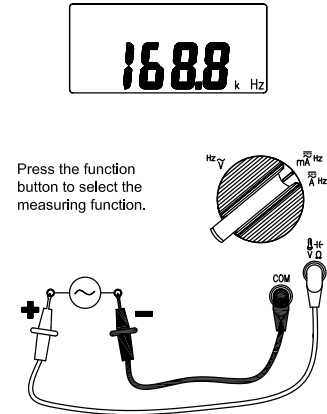

Press the function button to select the measuring function.

Rotate the switch and press the Function button to select the measuring function.
See "Using the Function Buttons"

Measuring Resistance/Capacitance

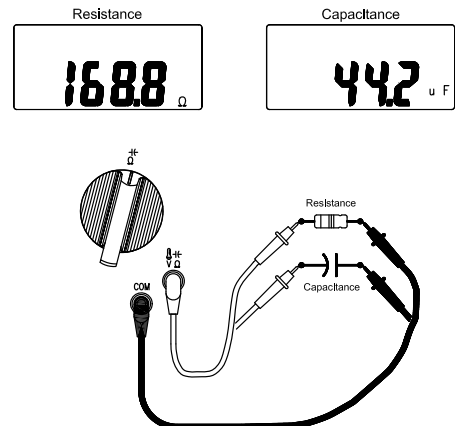

Rotate the switch and press the Function button to select the measuring function.
See "Using the Function Buttons"

Measuring Continuity / Diode

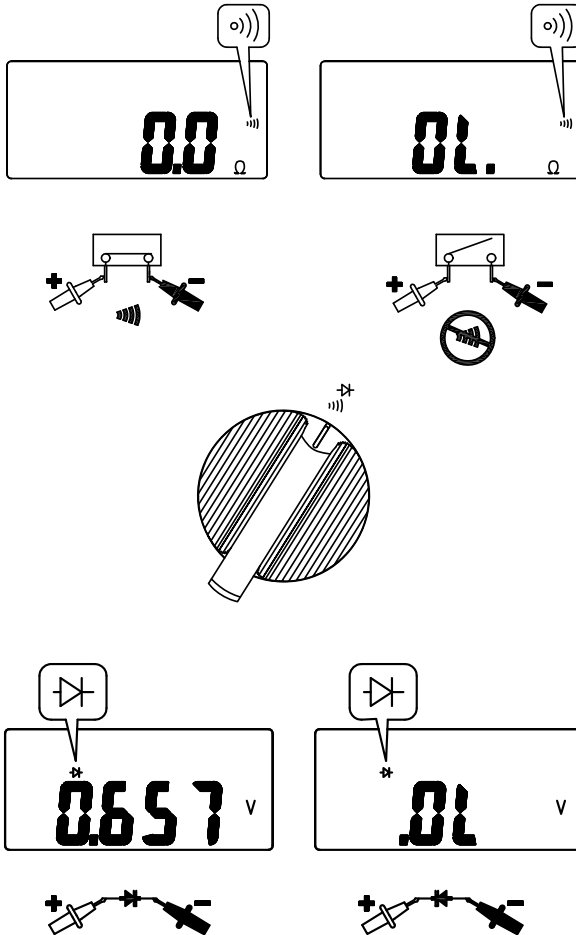

Rotate the switch and press the Function button to select the measuring function.
See "Using the Function Buttons"

Measuring Temperature °C / °F (for IDM99-III only)

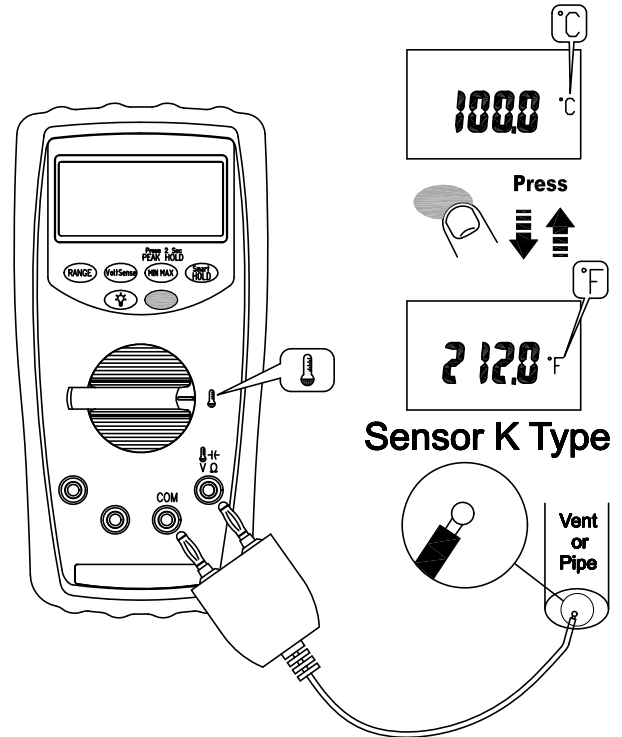

Rotate the switch and press the Function button to select the measuring function.

See "Using the Function Buttons" (°C / °F)

Using The Function Buttons

Function Button

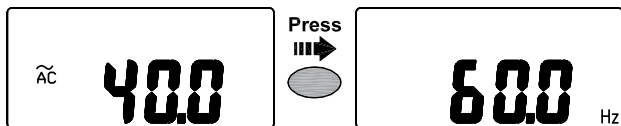

Switch Position	Function
Hz \tilde{V}	$\tilde{V} \Rightarrow$ Hz
mV \tilde{V}	$m\tilde{V} \Rightarrow m\tilde{V}$
Ω	$\Omega \Rightarrow \Omega$
μA	$\mu A \Rightarrow \mu A$
mA Hz	$m\tilde{A} \Rightarrow$ Hz $\Rightarrow m\tilde{A}$
A Hz	$\tilde{A} \Rightarrow$ Hz $\Rightarrow \tilde{A}$
	$^{\circ}C \Rightarrow$ $^{\circ}F$

Press the Function button to change the function on the same switch position.

RANGE Button

Auto Range Mode

Manual Range Mode

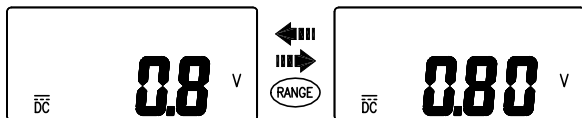

Press button to select the display range.

MIN/MAX Button

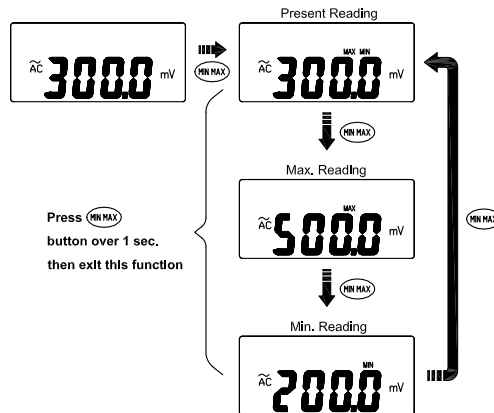

The MAX/MIN mode records the min. and max. input values. When the input goes below the recorded min. value or above the recorded max. value, the meter records the new value. Press "HOLD" button to pause the recording.

Peak HOLD (for IDM99-III only)

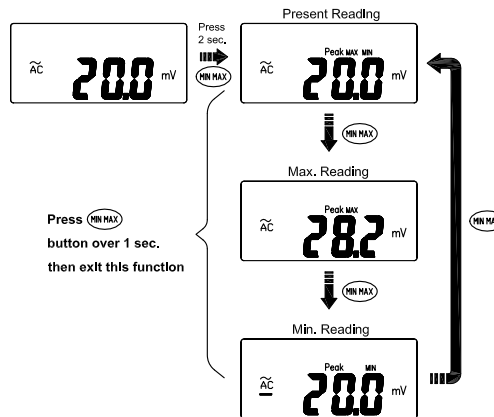

In the Peak HOLD function, the meter records the peak min. value and the peak max. value; when the inputs goes below the recorded peak min. value or above the recorded peak max. value, the meter records the new value. Press "HOLD" button to pause the recording.

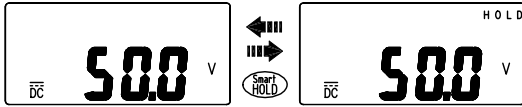
Smart HOLD

The meter will beep continuously and the display will flash if the measured signal is larger than the display reading by 50 counts. Smart Hold will not be activated if the hold value is not scrolled over 50 counts when measuring AC or DC Voltage /Current with Auto-V(LoZ) Range.

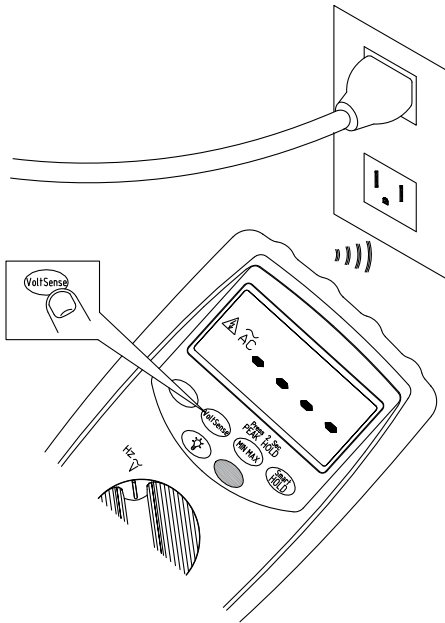
VoltSense

Press and hold down the "VoltSense" button down to activate the VoltSense function.

⚠ CAUTION

The number of dashes displayed indicates the electric field strength. Be aware, if no indication, voltage could still be present

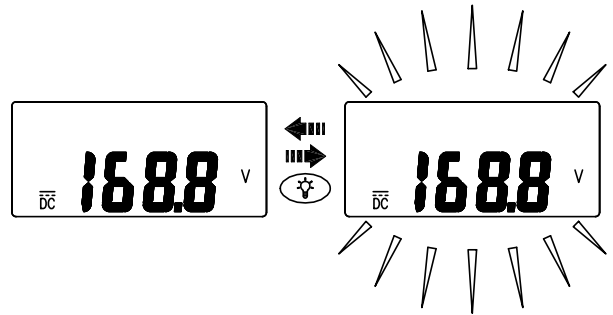
Backlight

Press the Backlight button to turn the backlight on/off.

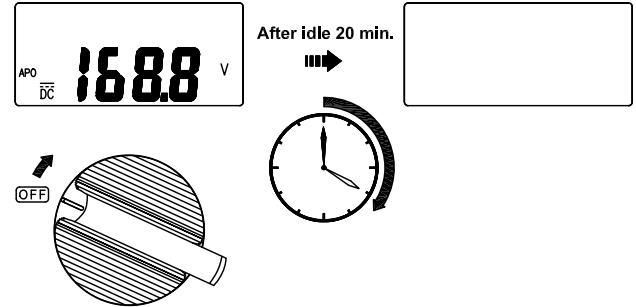
Disable Auto Power Off

Reactivate the instrument by rotating the switch or by pressing any button.

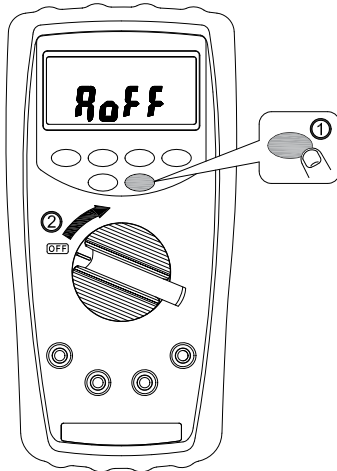
Auto Power Off Disable

Rotate the switch to the "OFF" position, Press and hold down the Function button and turn the instrument on.

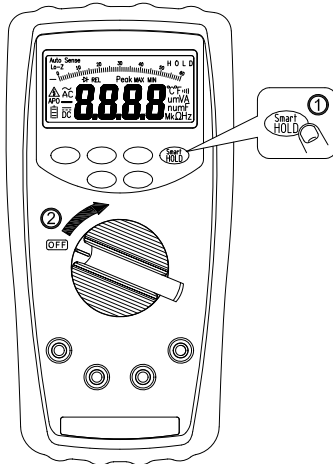
Testing the LCD Display

Rotate the switch to the "OFF" position, Press and hold down the Smart-HOLD button and turn the instrument on.

SECTION 4 – BATTERY AND FUSE REPLACEMENT**⚠ CAUTION**

The following safety information must be observed to ensure maximum personal safety during the operation of this instrument.

1. To avoid electric shock, disconnect the test leads before replacing the instrument fuses or batteries.
2. When replacing the instrument batteries, do not mix batteries of different types or old and new batteries.
3. Check the battery polarity carefully when inserting the batteries.
4. Do not short-circuit used batteries, disassemble them, or throw them in a fire. Doing so may cause the batteries to explode.
5. Dispose of the used batteries in accordance with local regulations.

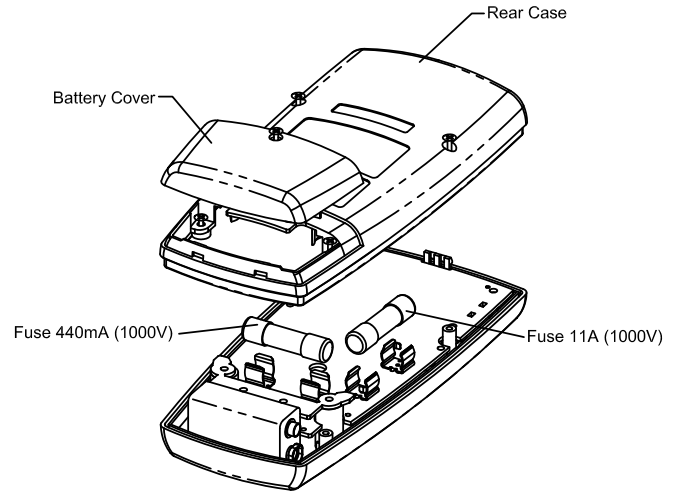
Fuse Replacement**⚠ Caution**

Use only fuses with the following fuse rating:

- 440mA, 1000V IR 10KA Fast acting fuse (size 35 x 10mm)
DMM-B-44/100 – 10,000A, 1000 VAC, unity power factor and 10,000A, 1000 VDC with time constant of 2.2ms
- 11A, 1000V IR 20KA Fast acting fuse (size 38 x 10mm)
DMM-B-11A – 20,000A, 1000 VAC, power factor ≤ 0.2 ; 20,000A, 1000 VDC, time constant ≥ 10 ms. (size 38 x 10mm)

Low battery and Battery Replacement

Replace the battery as soon as the low battery indicator appears to avoid false reading.

Refer to the following figure to replace the batteries

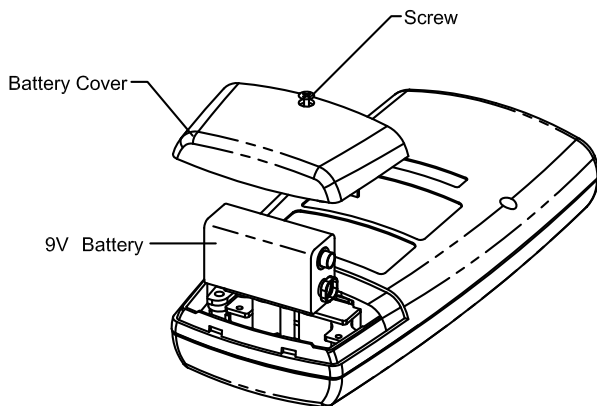

SECTION 5 - SPECIFICATIONS

General Specifications

Maximum voltage applied to any terminal : 1000 Vac rms or 1000 Vdc. rms

Display : 6000 counts.

Polarity Indication : Automatic, positive implied, negative indicated.

Overrange Indication : OL

Batteries Life : 150hours alkaline battery (No backlight)

Low Batteries Indication : Voltage drops below operating voltage, "⏻" will flash.

Power Requirement : PP3 9V battery

Auto Power Off : 20 minutes.

Operating Temperature : -10 ~10°C

10°C ~ 30°C (≅80% RH),

30°C ~ 40°C (≅75% RH),

40°C ~ 50°C (≅45%RH)

Storage Temperature : -20°C to 60°C , 0 to 80% R.H. (batteries not fitted)

Temperature Coefficient : 0.15 x (Spec.Accy) / °C, < 18°C or > 28°C .

Measure : Samples 3 times per second .

Altitude : 6561.7 ft (2000m)

Safety : Complies with EN61010-1, UL61010-1, IEC 61010-1, CAT IV 600V, CAT III 1000V

Measurement Category	Application
I	Measurements on circuits not directly connected to mains. Examples include: Measurements on battery powered equipment and specially protected (internal) mains-derived circuits.
II	Measurements on circuits directly connected to the low voltage installation. Examples include: Household appliances, portable tools and similar equipment.
III	Measurements performed in the building installation. Examples include measurements on distribution boards, junction boxes, socket-outlets and wiring and cables in the fixed installation.
IV	Measurements performed at the source of the low-voltage installation. Examples include measurements on primary overcurrent protection devices and electricity Instruments

Weight : 460g (including battery)

Dimensions (W x H x D) : 94mm x190mm x 48mm with holster.

Pollution degree : 2

EMC : EN 61326-1

Shock vibration : Sinusoidal vibration per MIL-PRF- 28800F (5 ~ 55 Hz, 3g max.)

Drop Protection : 4 feet drop to hardwood on concrete floor.

Indoor use only.

Electrical Specifications

Accuracy is \pm (% reading + number of digits) at 23°C \pm 5°C < 80%RH.

(1) Voltage

IDM98-III/IDM99-III			
Range	Resolution	IDM98-III Accuracy	IDM99-III Accuracy
60.00mV _{DC}	0.01mV	–	\pm (0.08% + 10d)
600.0mV _{DC}	0.1mV	\pm (0.1% + 2d)	\pm (0.08% + 2d)
6.000V _{DC}	0.001V	\pm (0.09% + 2d)	\pm (0.08% + 2d)
60.00V _{DC}	0.01V	\pm (0.09% + 2d)	\pm (0.08% + 2d)
600.0V _{DC}	0.1V	\pm (0.09% + 2d)	\pm (0.08% + 2d)
1000V _{DC}	1V	\pm (0.09% + 2d)	\pm (0.08% + 2d)
60.00mV _{AC}	0.01mV	–	\pm (1.20% + 5d)
600.0mV _{AC}	0.1mV	\pm (1.5% + 5d)	\pm (1.20% + 5d)
6.000V _{AC}	0.001V	\pm (1.0% + 3d)	\pm (0.80% + 5d)
60.00V _{AC}	0.01V	\pm (1.0% + 3d)	\pm (0.80% + 5d)
600.0V _{AC}	0.1V	\pm (1.0% + 3d)	\pm (0.80% + 5d)
1000V _{AC}	1V	\pm (1.0% + 3d)	\pm (0.80% + 5d)

Input Protection : 1000VDC or 1000VAC rms

AC Frequency Response : 50Hz ~ 1KHz

Input Impedance : 10M Ω , <100pF

AC Conversion Type :

AC conversions are ac-coupled, true rms responding, calibrated to the sine wave input.

For non-sine wave add the following Crest Factor corrections:

For Crest Factor of 1.4 to 2.0, add 1.0% to accuracy.

For Crest Factor of 2.0 to 2.5, add 2.5% to accuracy.

For Crest Factor of 2.5 to 3.0, add 4.0% to accuracy.

(2) Auto-V

IDM98-III/IDM99-III			
Range	Resolution	IDM98-III Accuracy	IDM99-III Accuracy
600.0V _{DC}	0.1V	\pm (1.0% + 3d)	\pm (0.80% + 3d)
1000V _{DC}	1V		
600.0V _{AC}	0.1V		
1000V _{AC}	1V		

Input Protection : 1000V_{DC} or 1000V_{AC} rms

AC Frequency Response : 50Hz ~ 1KHz

Input Impedance : Approx. 3k Ω .

AC Conversion Type :

Conversion type and additional specification are same as voltage function.

(3) Current

IDM98-III/IDM99-III			
Range	Resolution	IDM98-III Accuracy	IDM99-III Accuracy
60.00mA _{DC}	0.01mA	\pm (1.0% + 3d)	\pm (0.8% + 3d)
600.0mA _{DC}	0.1mA	\pm (1.0% + 3d)	\pm (0.8% + 3d)
6.000A _{DC}	0.001A	\pm (1.0% + 3d)	\pm (0.8% + 3d)
10.00A _{DC}	0.01A	\pm (1.0% + 3d)	\pm (0.8% + 3d)
60.00mA _{AC}	0.01mA	\pm (1.5% + 3d)	\pm (1.2% + 3d)
600.0mA _{AC}	0.1mA	\pm (1.5% + 3d)	\pm (1.2% + 3d)
6.000A _{AC}	0.001A	\pm (1.5% + 3d)	\pm (1.2% + 3d)
10.00A _{AC}	0.01A	\pm (1.5% + 3d)	\pm (1.2% + 3d)

Input Protection : Protected by high energy fuses.

440mA, 1000V AC/DC 10KA Fast acting fuse for mA input. 11A, 1000V AC/DC 20KA Fast acting fuse for A input

Max. Measuring Time : 3 minutes for "A" input, 10 minutes for "mA" input.

Rest time 20 minutes min.

AC Conversion Type : Conversion type and additional specification are same

as voltage function.

AC Frequency Response : 50Hz ~ 1KHz

(4) Peak HOLD (For IDM99-III only)Specified accuracy $\pm 150d$.**(5) Resistance**

IDM98-III/IDM99-III		
Range	Resolution	Accuracy
600.0 Ω	0.1 Ω	$\pm (0.8\% + 5d)$
6.000K Ω	0.001K Ω	$\pm (0.8\% + 2d)$
60.00K Ω	0.01K Ω	
600.0K Ω	0.1K Ω	
6.000M Ω	0.001M Ω	
40.00M Ω^*	0.01M Ω	$\pm (1.0\% + 5d)$

Input Protection : 1000V_{DC} or 1000V_{AC} rms**Max. Open Circuit Voltage** : Approx. 2.5V for 600 Ω & 6k Ω Range.
Approx. 0.6V for others.**Max. Test Current** : Approximately 0.1mA.* There is a little rolling less than ± 50 digits when measuring $> 10.00M\Omega$.**(6) Continuity Check**

IDM98-III/IDM99-III		
Range	Resolution	Accuracy
600.0 Ω	0.1 Ω	$\pm (0.8\% + 5d)$

Input Protection : 1000V_{DC} or 1000V_{AC} rms**Max. Open Circuit Voltage** : Approx. 2.5V**Max. Test Current** : Approx. 0.1mA**Continuity Threshold** : $< 30\Omega$ Beep On.
 $> 100\Omega$ Beep OFF.**Continuity Indicator** : 2.7kHz Tone Buzzer**(7) Diode Test**

IDM98-III/IDM99-III		
Range	Resolution	Accuracy
2.000V	1mV	$\pm (1.5\% + 2d)$

Input Protection : 1000V_{DC} or 1000V_{AC} rms**Max. Open Circuit Voltage** : Approximately. 2.5V**Max. Test Current** : Approximately 0.4mA**(8) Capacitance**

IDM98-III/IDM99-III		
Range	Resolution	Accuracy
1.000 μ F	0.001 μ F	$\pm (1.2\% + 2d)$
10.00 μ F	0.01 μ F	
100.0 μ F	0.1 μ F	
1.000mF	0.001mF	
10.00mF	0.01mF	

Input Protection : 1000V_{DC} or 1000V_{AC} rms**Max. Measuring Time** : 0.7 sec for 1nF~1mF

3 sec for 1mF~10mF

(9) Frequency Counter

IDM98-III/IDM99-III		
Range	Resolution	Accuracy
100.00Hz	0.01Hz	$\pm (0.1\% + 2d)$
1000.0Hz	0.1Hz	
10.000KHz	0.001KHz	
100.00KHz	0.01KHz	

Input Protection : 1000V_{DC} or 1000V_{AC} rms**Min. Frequency** : 1Hz**Sensitivity** : $> 5.0Vp-p$ (for ACV 1Hz ~ 10kHz).
 $> 10Vp-p$ (for ACV 10kHz ~ 100kHz).
 $> 2mAp-p$ (for AC mA).
 $> 0.2Ap-p$ (for ACA).

(10) Temperature (For IDM99-III only)

IDM99-III		
Range	Resolution	Accuracy
-40.0°C ~ 400°C	0.1°C	± (1.0% + 10d)
-40.0°F ~ 752°F	0.1°F	± (1.0% + 18d)

Input Protection : 1000V_{DC} or 1000V_{AC} rms

* Does not include accuracy of the thermocouple probe.

* Accuracy specification assumes surrounding temperature stable to ± 1°C. For surrounding temperature changes of ± 5°C, rated accuracy applies after 2 hours.

(11) AC+DC Voltage

Note: When measuring AC+DC, the AC signal may contain a DC level, the AC+DC True RMS value might not be accurate if the peak voltage of AC+DC value is over full scale.

IDM98-III/IDM99-III			
Range	Resolution	IDM98-III Accuracy	IDM99-III Accuracy
6.000V	0.001V	± (2.5% + 5d)	± (2% + 5d)
60.00V	0.01V		
600.0V	0.1V		
1000V	1V		

Additional specification are same as voltage function.

(12) AC+DC mV

IDM98-III/IDM99-III			
Range	Resolution	IDM98-III Accuracy	IDM99-III Accuracy
60.00mV	0.01mV	–	± (2% + 10d)
600.0mV	0.1mV	± (2.5% + 5d)	

Additional specification are same as voltage function.

(13) AC+DC mA

IDM98-III/IDM99-III			
Range	Resolution	IDM98-III Accuracy	IDM99-III Accuracy
60.00mA	0.01mA	± (2.5% + 5d)	± (2% + 10d)
600.0mA	0.1mA		

Additional specification are same as voltage function.

(14) AC+DC A

IDM98-III/IDM99-III			
Range	Resolution	IDM98-III Accuracy	IDM99-III Accuracy
6.000A	0.001A	± (2.5% + 5d)	± (2% + 5d)
10.00A	0.01A		

Additional specification are same as voltage function.

Africa

RS Components SA

P.O. Box 12182,
Vorna Valley, 1686
20 Indianapolis Street,
Kyalami Business Park,
Kyalami, Midrand
South Africa

www.rs-components.com

Asia

RS Components Pte Ltd.

31 Tech Park Crescent
Singapore 638040

www.rs-components.com

China

RS Components Ltd.

Suite 23 A-C
East Sea Business Centre
Phase 2
No. 618 Yan'an Eastern Road
Shanghai, 200001
China

www.rs-components.com

Europe

RS Components Ltd.

PO Box 99, Corby,
Northants.
NN17 9RS
United Kingdom

www.rs-components.com

Japan

RS Components Ltd.

West Tower (12th Floor),
Yokohama Business Park,
134 Godocho, Hodogaya,
Yokohama, Kanagawa 240-0005
Japan

www.rs-components.com

U.S.A

Allied Electronics

7151 Jack Newell Blvd. S.
Fort Worth,
Texas 76118
U.S.A.

www.alliedelec.com

South America

RS Componentes Limitada

Av. Pdte. Eduardo Frei M. 6001-71
Centro Empresas El Cortijo
Conchali, Santiago, Chile

www.rs-components.com