

MARKING:

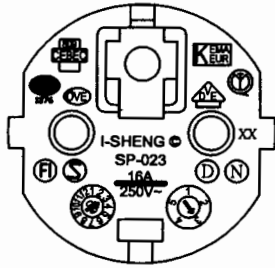

MARKING:

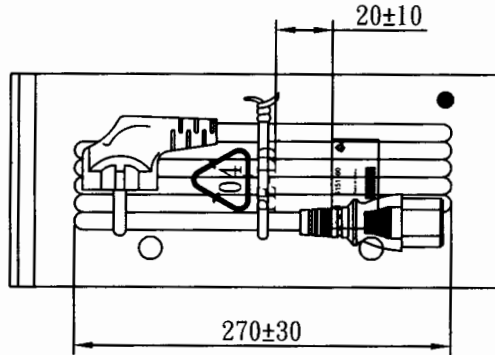
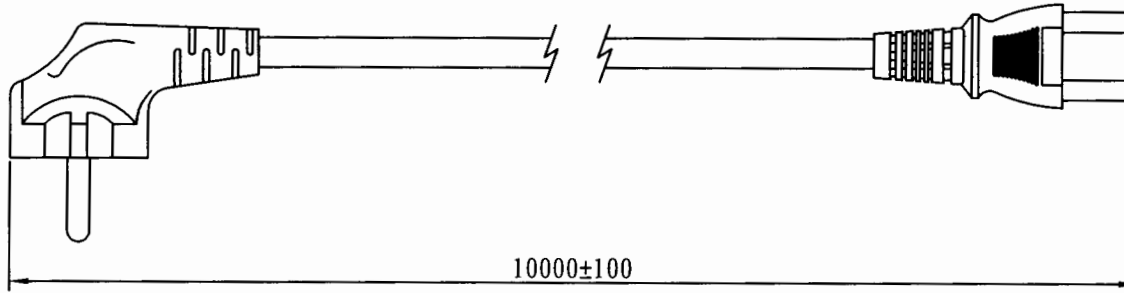
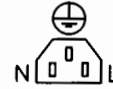
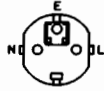
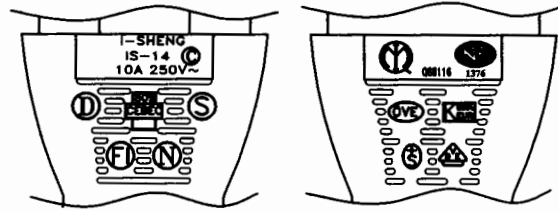

WIRING COLOR:

- E: Yellow/Green
- N: Blue
- L: Brown

LENGED ON CORD: (206-14)

I-SHENG SGIS <VDE> KEMA-KEUR <VDE> △ CEPEC 809  
 NF-USE 1346 IEMMEQU H05VV-F 3G 1.5mm<sup>2</sup> 60227 IEC 53 RVV 300/500V  
 A003083 3ASL/150 4V-75 V-75 (75°C) 250/440V ORDINARY DUTY Q96257 -LF- CE



No	BOM ITEM	Q' TY	P/N
1	SP-023 INSERT(BLACK)	1 PCS	MB023012
2	PVC 45P (SA87, SP-023)	45 g	RPP04512
3	KPR-14 TERMINAL	3 pcs	BBB14000
4	IS-14 INNER BODY	1 set	MI014000
5	PVC 45P (SA87, IS-14)	22 g	RPP04512
6	PE TIE (BLACK, 12 inch)	1 pcs	KBB10012
7	PE BAG(370*200*0.06)	1 pcs	KPR1100R
8	LABLE	1 pcs	

NOTE : 1. CORD : EAN-128C

2 : SCAN CONTENT : 6151160

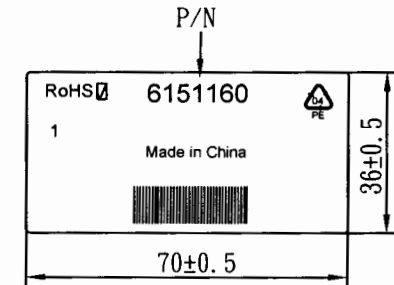

CABLE H05VV-F 3G 1.5 DENT PRINT CT-12 (BLACK)						
PLUG		SP-023 + IS-14	LENGTH	10000	UNIT	mm
CLIENT	NAME	First Connectivity	N/W	1.227895	UNIT	kg
	P/N	6151160	SG DWG	SR-142461-2	VER.	A
				Design. by	楊望春	
				Review. by		
				Approval. by	15/11/2016	
Y34 6E3016 12 10M 01						