

PCB LAYOUT - COMPONENT VIEW

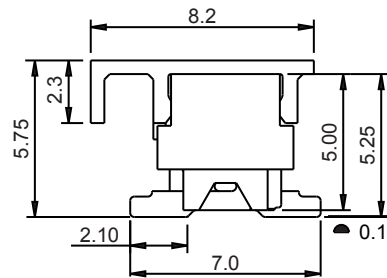
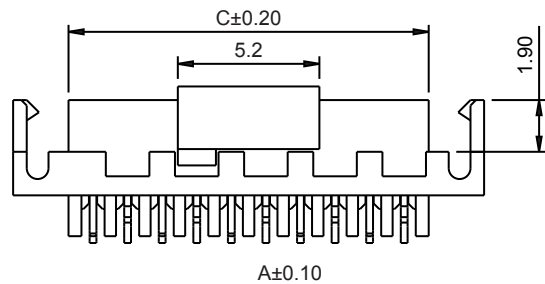

MATERIAL:  
 HOUSING MATERIAL: PA6T  
 FLAMABILITY RATING: UL94-V0  
 COLOR: RED  
 CONTACT MATERIAL: PHOSPHOR BRONZE  
 CONTACT TYPE: STAMPED  
 CONTACT PLATING: MATT TIN OVER NICKEL  
 QUALITY CLASS: 25 MATING CYCLES  
 PITCH; 2.54 MM PER ROW

ENVIRONMENTAL:  
 OPERATING TEMPERATURE: -40°C UP TO 105°C  
 COMPLIANCE: LEAD FREE AND ROHS

ELECTRICAL:  
 CURRENT RATING: 1.5A PER PIN (PCB PIN)  
 WORKING VOLTAGE: 100VAC  
 INSULATION RESISTANCE: >1000MOHM  
 DIELECTRIC WITHSTANDING VOLT.: 500VAC/MN  
 CONTACT RESISTANCE: 10mOHM MAX

STANDARD  
 RoHS CERTIFIED: E323964 / MOD. NUMBER 69036729xx7x

SOLDERING:  
 REFLOW PROCESS ONLY

DIMENSION:  
 DIM.A= 1.27 x (Nb PIN -1)  
 DIM.B= DIM.A + 5.87  
 DIM.C= DIM.A + 1.80

AVAILABLE  
 xx : 4 TO 26 CIRCUITS

PACKAGING:  
 TAPE & REEL

RoHS Compliant			
G			
F	07-APR-10	PINNING	JP
E	09-MAR-10	STANDARD	JP
D	17-NOV-09	DIMENSION	JP
C	10-AUG-09	LATCH SHAPE	CH
B	27-NOV-07	MODIFICATIONS	EC
A	03-NOV-06	PDF	JP
REV	DATE	FILE	BY

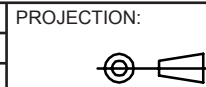

GENERAL TOLERANCE  
 .X = +/- 0.2  
 .XX = +/- 0.15



APPROVAL: RJ

UNIT: MM

DESCRIPTION: MM FEMALE SMT CONNECTOR WITH LATCH AND POLARIZATION

SIZE

SCALE:

WERI PART NO: 690 367 29 xx 76

**A4**

SHEET: 1/2

DRAW: EAGER

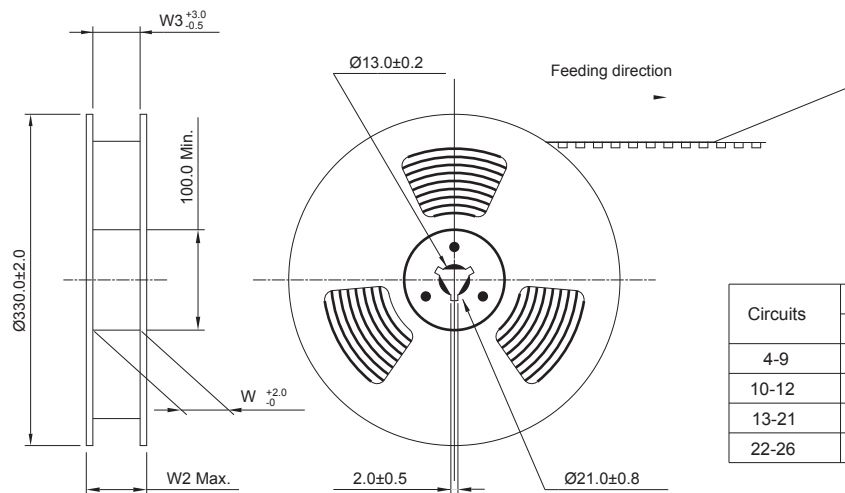

NOTE :

- \* Reel Material : HIPS
- \* Carrier Material : Transparent Anti-static Polysyrene.
- \* Cover Tape Material : Polyester
- \* Cover Tape Peel Strength : 0.1N - 1.3N
- \* Carrier camber is within 1mm in 250mm
- \* All dimensions meet EIA-481-2 requirements.
- \* Quantity : 600 PCS/Reel

Circuits	Dimension					Packing (Reel/Caton)
	E	F	W1	W2	W3	
4-9	24.0(.945)	-	24.5(.965)	30.5(1.200)	24.5(.965)	8
10-12	32.0(1.260)	28.40(1.118)	32.5(1.280)	38.5(1.516)	32.5(1.280)	6
13-21	44.0(1.732)	40.40(1.596)	44.5(1.752)	50.5(1.988)	44.5(1.752)	5
22-26	56.0(2.205)	52.40(2.063)	56.5(2.224)	62.5(2.460)	56.5(2.224)	4

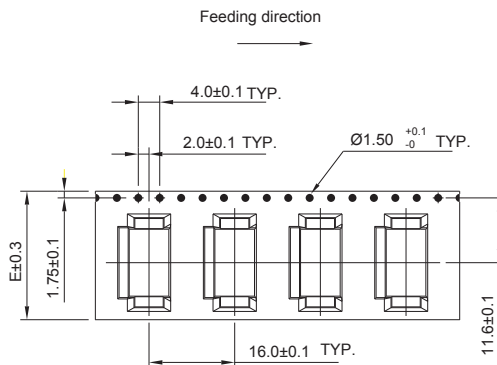
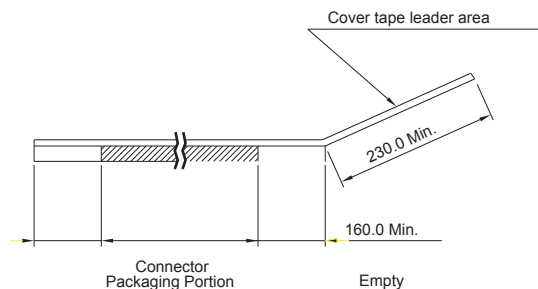

WIDTH : 24 mm Carrier

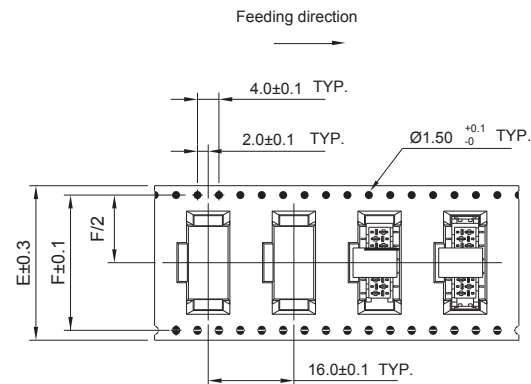

WIDTH : 32,44,56 mm Carrier

RoHS Compliant			
G			
F			
E			
D			
C			
B			
A			
REV	DATE	FILE	BY

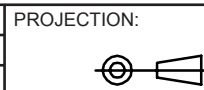

GENERAL TOLERANCE  
 .X = +/- 0.2  
 .XX = +/- 0.15



APPROVAL: RJ

UNIT: MM

DESCRIPTION: MM FEMALE SMT CONNECTOR WITH LATCH AND POLARIZATION

SCALE:

SHEET: 2/2

WERI PART NO: 69036729 xx 76

DRAW: EAGER

SIZE  
**A4**