

Cree® PLCC6 3 in 1 SMD LED CLP6B-WKW&MKW

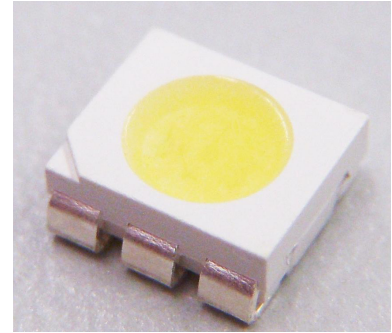

PRODUCT DESCRIPTION

These SMD LEDs are packaged in an industry-standard PLCC6 package. These high-reliability and high-brightness LEDs are designed to work in a wide range of environmental conditions and are ideally suited for use in illumination applications.

Their wide viewing angle makes these LEDs ideally suited for channel letters or general backlighting and illumination applications. The flat-top emitting surface makes it easy for these LEDs to mate with light pipes.

FEATURES

- Size (mm):6.0 x 5.0
- Color Temperatures (K):
CLP6B-WKW:
Min.(4600), Typical.(6800)
CLP6B-MKW:
Min.(2500), Typical.(3200)
- Luminous Intensity (mcd):
Cool White(9000-22400)
Warm White (7100-18000)
- CRI:
Typical CRI for Cool White (4600-15000k) is 72.
Typical CRI for Warm White (2500-4600k) is 80.
- Lead-Free
- RoHS Compliant

APPLICATIONS

- Light Strip
- Channel Letter
- Backlight

ABSOLUTE MAXIMUM RATINGS ($T_A = 25^\circ\text{C}$)

Items	Symbol	Absolute Maximum Rating	Unit
		Cool/Warm	
Forward Current	I_F	3 x 50	mA
Peak Forward Current ^{Note}	I_{FP}	3 x 100	mA
Reverse Voltage	V_R	5	V
Power Dissipation	P_D	3 x 220	mW
Operation Temperature	T_{opr}	-40 ~ +100	$^\circ\text{C}$
Storage Temperature	T_{stg}	-40 ~ +100	$^\circ\text{C}$
Junction Temperature	T_J	110	$^\circ\text{C}$
Junction/Ambient	R_{THJA}	3 x 300	$^\circ\text{C}/\text{W}$
Junction/Solder Point	R_{THJS}	3 x 160	$^\circ\text{C}/\text{W}$

Notes: Pulse width ≤ 0.1 msec, duty $\leq 1/10$.

TYPICAL ELECTRICAL & OPTICAL CHARACTERISTICS ($T_A = 25^\circ\text{C}$)

Characteristics	Color	Symbol	Condition	Unit	Minimum	Typical	Maximum
Forward Voltage	Cool/Warm	V_F	$I_F = 50$ mA	V		3.8	4.4
Reverse Current	Cool/Warm	I_R	$V_R = 5$ V	μA			10
Luminous Flux	Cool	Φ_V	$I_F = 3 \times 50$ mA	mlm		32000	
	Warm	Φ_V	$I_F = 3 \times 50$ mA	mlm		30000	
Luminous Intensity	Cool	I_V	$I_F = 3 \times 50$ mA	mcd	9000	14000	
	Warm	I_V	$I_F = 3 \times 50$ mA	mcd	7100	12000	
Chromaticity Coordinates	Cool	x	$I_F = 3 \times 50$ mA			0.3100	
	Warm	y	$sI_F = 3 \times 50$ mA			0.3200	

INTENSITY BIN LIMIT ($I_F = 3 \times 50 \text{ mA}$)

Cool White

Bin Code	Min. (mcd)	Max. (mcd)
C0	9000	11200
D0	11200	14000
E0	14000	18000
F0	18000	22400

Warm White

Bin Code	Min. (mcd)	Max. (mcd)
B0	7100	9000
C0	9000	11200
D0	11200	14000
E0	14000	18000

- Tolerance of measurement of luminous intensity is $\pm 10\%$

VF BIN LIMIT ($I_F = 50 \text{ mA}$)

Cool White

Bin Code	Min. (V)	Max. (V)
29	3.2	3.4
2a	3.4	3.6
2b	3.6	3.8
2c	3.8	4.0
2d	4.0	4.2
2e	4.2	4.4

Warm White

Bin Code	Min. (V)	Max. (V)
29	3.2	3.4
2a	3.4	3.6
2b	3.6	3.8
2c	3.8	4.0
2d	4.0	4.2
2e	4.2	4.4

- Tolerance of measurement of VF is $\pm 0.05\text{V}$.

COLOR BIN LIMIT ($I_F = 3 \times 50 \text{ mA}$)

Cool White

Bin Code	Sub-bin	x	y
W1	Wa1	0.2449	0.2288
		0.2497	0.2384
		0.2543	0.2356
		0.2497	0.2267
	Wa2	0.2497	0.2267
		0.2543	0.2356
		0.2589	0.2328
		0.2545	0.2245
	Wa3	0.2497	0.2384
		0.2545	0.2480
		0.2589	0.2445
		0.2543	0.2356
	Wa4	0.2543	0.2356
		0.2589	0.2445
		0.2633	0.2410
		0.2589	0.2328
	Wb1	0.2545	0.2245
		0.2589	0.2328
		0.2635	0.2299
		0.2593	0.2223
	Wb2	0.2593	0.2223
		0.2635	0.2299
		0.2680	0.2270
		0.2640	0.2200
	Wb3	0.2589	0.2328
		0.2633	0.2410
		0.2677	0.2375
		0.2635	0.2299
	Wb4	0.2635	0.2299
		0.2677	0.2375
		0.2720	0.2340
		0.2680	0.2270

Bin Code	Sub-bin	x	y
W1	Wc1	0.2545	0.2480
		0.2593	0.2575
		0.2635	0.2534
		0.2589	0.2445
	Wc2	0.2589	0.2445
		0.2635	0.2534
		0.2677	0.2493
		0.2633	0.2410
	Wc3	0.2593	0.2575
		0.2640	0.2670
		0.2680	0.2623
		0.2635	0.2534
	Wc4	0.2635	0.2534
		0.2680	0.2623
		0.2720	0.2575
		0.2677	0.2493
	Wd1	0.2633	0.2410
		0.2677	0.2493
		0.2718	0.2451
		0.2677	0.2375
	Wd2	0.2677	0.2375
		0.2718	0.2451
		0.2760	0.2410
		0.2720	0.2340
	Wd3	0.2677	0.2493
		0.2720	0.2575
		0.2760	0.2528
		0.2718	0.2451
Wd4	0.2718	0.2451	
	0.2760	0.2528	
	0.2800	0.2480	
	0.2760	0.2410	

Bin Code	Sub-bin	x	y
W2	We1	0.2640	0.2670
		0.2688	0.2765
		0.2726	0.2711
		0.2680	0.2623
	We2	0.2680	0.2623
		0.2726	0.2711
		0.2764	0.2658
		0.2720	0.2575
	We3	0.2688	0.2765
		0.2735	0.2860
		0.2772	0.2800
		0.2726	0.2711
	We4	0.2726	0.2711
		0.2772	0.2800
		0.2808	0.2740
		0.2764	0.2658
	Wf1	0.2720	0.2575
		0.2764	0.2658
		0.2802	0.2604
		0.2760	0.2528
	Wf2	0.2760	0.2528
		0.2802	0.2604
		0.2840	0.2550
		0.2800	0.2480
	Wf3	0.2764	0.2658
		0.2808	0.2740
		0.2844	0.2680
		0.2802	0.2604
Wf4	0.2802	0.2604	
	0.2844	0.2680	
	0.2880	0.2620	
	0.2840	0.2550	

- Tolerance of measurement of the color coordinates is ± 0.01 .

COLOR BIN LIMIT ($I_f = 3 \times 50 \text{ mA}$)

Cool White

Bin Code	Sub-bin	x	y
W2	Wg1	0.2735	0.2860
		0.2783	0.2955
		0.2817	0.2889
		0.2772	0.2800
	Wg2	0.2772	0.2800
		0.2817	0.2889
		0.2852	0.2823
		0.2808	0.2740
	Wg3	0.2783	0.2955
		0.2830	0.3050
		0.2863	0.2978
		0.2817	0.2889
	Wg4	0.2817	0.2889
		0.2863	0.2978
		0.2895	0.2905
		0.2852	0.2823
	Wh1	0.2808	0.2740
		0.2852	0.2823
		0.2886	0.2756
		0.2844	0.2680
	Wh2	0.2844	0.2680
		0.2886	0.2756
		0.2920	0.2690
		0.2880	0.2620
	Wh3	0.2852	0.2823
		0.2895	0.2905
		0.2928	0.2833
		0.2886	0.2756
Wh4	0.2886	0.2756	
	0.2928	0.2833	
	0.2960	0.2760	
	0.2920	0.2690	

Bin Code	Sub-bin	x	y
W3	Wj1	0.2830	0.3050
		0.2890	0.3130
		0.2918	0.3048
		0.2863	0.2978
	Wj2	0.2863	0.2978
		0.2918	0.3048
		0.2947	0.2967
		0.2895	0.2905
	Wj3	0.2890	0.3130
		0.2950	0.3210
		0.2974	0.3119
		0.2918	0.3048
	Wj4	0.2918	0.3048
		0.2974	0.3119
		0.2998	0.3028
		0.2947	0.2967
	Wk1	0.2895	0.2905
		0.2947	0.2967
		0.2975	0.2890
		0.2928	0.2833
	Wk2	0.2928	0.2833
		0.2975	0.2890
		0.3003	0.2813
		0.2960	0.2760
	Wk3	0.2947	0.2967
		0.2998	0.3028
		0.3022	0.2946
		0.2975	0.2890
Wk4	0.2975	0.2890	
	0.3022	0.2946	
	0.3045	0.2865	
	0.3003	0.2813	

Bin Code	Sub-bin	x	y
W3	Wm1	0.2950	0.3210
		0.3010	0.3290
		0.3030	0.3190
		0.2974	0.3119
	Wm2	0.2974	0.3119
		0.3030	0.3190
		0.3050	0.3090
		0.2998	0.3028
	Wm3	0.3010	0.3290
		0.3070	0.3370
		0.3085	0.3260
		0.3030	0.3190
	Wm4	0.3030	0.3190
		0.3085	0.3260
		0.3100	0.3150
		0.3050	0.3090
	Wn1	0.2998	0.3028
		0.3050	0.3090
		0.3070	0.3005
		0.3022	0.2946
	Wn2	0.3022	0.2946
		0.3070	0.3005
		0.3090	0.2920
		0.3045	0.2865
	Wn3	0.3050	0.3090
		0.3100	0.3150
		0.3115	0.3060
		0.3070	0.3005
Wn4	0.3070	0.3005	
	0.3115	0.3060	
	0.3130	0.2970	
	0.3090	0.2920	

- Tolerance of measurement of the color coordinates is ± 0.01 .

COLOR BIN LIMIT ($I_f = 3 \times 50 \text{ mA}$)

Cool White

Bin Code	Sub-bin	x	y
W4	Wp1	0.3070	0.3370
		0.3130	0.3430
		0.3140	0.3320
		0.3085	0.3260
	Wp2	0.3085	0.3260
		0.3140	0.3320
		0.3150	0.3210
		0.3100	0.3150
	Wp3	0.3130	0.3430
		0.3190	0.3490
		0.3195	0.3380
		0.3140	0.3320
	Wp4	0.3140	0.3320
		0.3195	0.3380
		0.3200	0.3270
		0.3150	0.3210
	Wq1	0.3100	0.3150
		0.3150	0.3210
		0.3163	0.3118
		0.3115	0.3060
	Wq2	0.3115	0.3060
		0.3163	0.3118
		0.3175	0.3025
		0.3130	0.2970
	Wq3	0.3150	0.3210
		0.3200	0.3270
		0.3210	0.3175
		0.3163	0.3118
	Wq4	0.3163	0.3118
		0.3210	0.3175
		0.3220	0.3080
		0.3175	0.3025

Bin Code	Sub-bin	x	y
W4	Wr1	0.3190	0.3490
		0.3245	0.3545
		0.3248	0.3438
		0.3195	0.3380
	Wr2	0.3195	0.3380
		0.3248	0.3438
		0.3250	0.3330
		0.3200	0.3270
	Wr3	0.3245	0.3545
		0.3300	0.3600
		0.3300	0.3495
		0.3248	0.3438
	Wr4	0.3248	0.3438
		0.3300	0.3495
		0.3300	0.3390
		0.3250	0.3330
	Ws1	0.3200	0.3270
		0.3250	0.3330
		0.3255	0.3230
		0.3210	0.3175
	Ws2	0.3210	0.3175
		0.3255	0.3230
		0.3260	0.3130
		0.3220	0.3080
	Ws3	0.3250	0.3330
		0.3300	0.3390
		0.3300	0.3285
		0.3255	0.3230
Ws4	0.3255	0.3230	
	0.3300	0.3285	
	0.3300	0.3180	
	0.3260	0.3130	

Bin Code	Sub-bin	x	y
W5	Wt1	0.3300	0.3600
		0.3378	0.3663
		0.3375	0.3563
		0.3300	0.3495
	Wt2	0.3300	0.3495
		0.3375	0.3563
		0.3372	0.3463
		0.3300	0.3390
	Wt3	0.3378	0.3663
		0.3455	0.3725
		0.3449	0.3630
		0.3375	0.3563
	Wt4	0.3375	0.3563
		0.3449	0.3630
		0.3443	0.3535
		0.3372	0.3463
	Wu1	0.3300	0.3390
		0.3372	0.3463
		0.3368	0.3363
		0.3300	0.3285
	Wu2	0.3300	0.3285
		0.3368	0.3363
		0.3365	0.3263
		0.3300	0.3180
	Wu3	0.3372	0.3463
		0.3443	0.3535
		0.3437	0.3440
		0.3368	0.3363
Wu4	0.3368	0.3363	
	0.3437	0.3440	
	0.3430	0.3345	
	0.3365	0.3263	

- Tolerance of measurement of the color coordinates is ± 0.01 .

COLOR BIN LIMIT ($I_f = 3 \times 50 \text{ mA}$)

Cool White

Bin Code	Sub-bin	x	y
W5	Wv1	0.3455	0.3725
		0.3533	0.3788
		0.3523	0.3698
		0.3449	0.3630
	Wv2	0.3449	0.3630
		0.3523	0.3698
		0.3514	0.3608
		0.3443	0.3535
	Wv3	0.3533	0.3788
		0.3610	0.3850
		0.3598	0.3765
		0.3523	0.3698
	Wv4	0.3523	0.3698
		0.3598	0.3765
		0.3585	0.3680
		0.3514	0.3608
	Ww1	0.3443	0.3535
		0.3514	0.3608
		0.3505	0.3518
		0.3437	0.3440
	Ww2	0.3437	0.3440
		0.3505	0.3518
		0.3495	0.3428
		0.3430	0.3345
	Ww3	0.3514	0.3608
		0.3585	0.3680
		0.3573	0.3595
		0.3505	0.3518
Ww4	0.3505	0.3518	
	0.3573	0.3595	
	0.3560	0.3510	
	0.3495	0.3428	

- Tolerance of measurement of the color coordinates is ± 0.01 .

COLOR BIN LIMIT ($I_f = 3 \times 50 \text{ mA}$)

Warm White

Bin Code	Sub-bin	x	y
M1	Ma1	0.3610	0.3900
		0.3715	0.3987
		0.3689	0.3853
		0.3593	0.3776
	Ma2	0.3715	0.3987
		0.3820	0.4075
		0.3786	0.3929
		0.3689	0.3853
	Ma3	0.3689	0.3853
		0.3786	0.3929
		0.3751	0.3783
		0.3664	0.3717
	Ma4	0.3593	0.3776
		0.3689	0.3853
		0.3664	0.3717
		0.3576	0.3651
	Mb1	0.3576	0.3651
		0.3664	0.3717
		0.3638	0.3582
		0.3559	0.3526
	Mb2	0.3664	0.3717
		0.3751	0.3783
		0.3717	0.3637
		0.3638	0.3582
	Mb3	0.3638	0.3582
		0.3717	0.3637
		0.3682	0.3491
		0.3612	0.3446
Mb4	0.3559	0.3526	
	0.3638	0.3582	
	0.3612	0.3446	
	0.3541	0.3401	

Bin Code	Sub-bin	x	y
M1	Mc1	0.3820	0.4075
		0.3925	0.4163
		0.3882	0.4006
		0.3786	0.3929
	Mc2	0.3925	0.4163
		0.4030	0.4250
		0.3978	0.4083
		0.3882	0.4006
	Mc3	0.3882	0.4006
		0.3978	0.4083
		0.3926	0.3915
		0.3839	0.3849
	Mc4	0.3786	0.3929
		0.3882	0.4006
		0.3839	0.3849
		0.3751	0.3783
	Md1	0.3751	0.3783
		0.3839	0.3849
		0.3796	0.3693
		0.3717	0.3637
	Md2	0.3839	0.3849
		0.3926	0.3915
		0.3874	0.3748
		0.3796	0.3693
	Md3	0.3796	0.3693
		0.3874	0.3748
		0.3822	0.3580
		0.3752	0.3536
Md4	0.3717	0.3637	
	0.3796	0.3693	
	0.3752	0.3536	
	0.3682	0.3491	

Bin Code	Sub-bin	x	y
M2	Me1	0.4030	0.4250
		0.4145	0.4320
		0.4084	0.4145
		0.3978	0.4083
	Me2	0.4145	0.4320
		0.4260	0.4390
		0.4189	0.4206
		0.4084	0.4145
	Me3	0.4084	0.4145
		0.4189	0.4206
		0.4118	0.4021
		0.4022	0.3968
	Me4	0.3978	0.4083
		0.4084	0.4145
		0.4022	0.3968
		0.3926	0.3915
	Mf1	0.3926	0.3915
		0.4022	0.3968
		0.3961	0.3793
		0.3874	0.3748
	Mf2	0.4022	0.3968
		0.4118	0.4021
		0.4047	0.3837
		0.3961	0.3793
	Mf3	0.3961	0.3793
		0.4047	0.3837
		0.3976	0.3653
		0.3899	0.3617
Mf4	0.3874	0.3748	
	0.3961	0.3793	
	0.3899	0.3617	
	0.3822	0.3580	

- Tolerance of measurement of the color coordinates is ± 0.01 .

COLOR BIN LIMIT ($I_F = 3 \times 50 \text{ mA}$)

Warm White

Bin Code	Sub-bin	x	y
M2	Mg1	0.4260	0.4390
		0.4375	0.4460
		0.4295	0.4268
		0.4189	0.4206
	Mg2	0.4375	0.4460
		0.4490	0.4530
		0.4400	0.4329
		0.4295	0.4268
	Mg3	0.4295	0.4268
		0.4400	0.4329
		0.4310	0.4128
		0.4214	0.4075
	Mg4	0.4189	0.4206
		0.4295	0.4268
		0.4214	0.4075
		0.4118	0.4021
	Mh1	0.4118	0.4021
		0.4214	0.4075
		0.4134	0.3882
		0.4047	0.3837
	Mh2	0.4214	0.4075
		0.4310	0.4128
		0.4220	0.3927
		0.4134	0.3882
	Mh3	0.4134	0.3882
		0.4220	0.3927
		0.4129	0.3725
		0.4053	0.3689
Mh4	0.4047	0.3837	
	0.4134	0.3882	
	0.4053	0.3689	
	0.3976	0.3653	

Bin Code	Sub-bin	x	y
M3	Mj1	0.4490	0.4530
		0.4638	0.4578
		0.4540	0.4372
		0.4400	0.4329
	Mj2	0.4638	0.4578
		0.4785	0.4625
		0.4679	0.4414
		0.4540	0.4372
	Mj3	0.4540	0.4372
		0.4679	0.4414
		0.4572	0.4203
		0.4441	0.4166
	Mj4	0.4400	0.4329
		0.4540	0.4372
		0.4441	0.4166
		0.4310	0.4128
	Mk1	0.4310	0.4128
		0.4441	0.4166
		0.4343	0.3960
		0.4220	0.3927
	Mk2	0.4441	0.4166
		0.4572	0.4203
		0.4466	0.3993
		0.4343	0.3960
	Mk3	0.4343	0.3960
		0.4466	0.3993
		0.4359	0.3782
		0.4244	0.3754
Mk4	0.4220	0.3927	
	0.4343	0.3960	
	0.4244	0.3754	
	0.4129	0.3726	

Bin Code	Sub-bin	x	y
M3	Mm1	0.4785	0.4625
		0.4933	0.4673
		0.4818	0.4457
		0.4679	0.4414
	Mm2	0.4933	0.4673
		0.5080	0.4720
		0.4957	0.4500
		0.4818	0.4457
	Mm3	0.4818	0.4457
		0.4957	0.4500
		0.4834	0.4279
		0.4703	0.4241
	Mm4	0.4679	0.4414
		0.4818	0.4457
		0.4703	0.4241
		0.4572	0.4203
	Mn1	0.4572	0.4203
		0.4703	0.4241
		0.4589	0.4026
		0.4466	0.3993
	Mn2	0.4703	0.4241
		0.4834	0.4279
		0.4711	0.4059
		0.4589	0.4026
	Mn3	0.4589	0.4026
		0.4711	0.4059
		0.4588	0.3838
		0.4474	0.3810
Mn4	0.4466	0.3993	
	0.4589	0.4026	
	0.4474	0.3810	
	0.4359	0.3782	

• Tolerance of measurement of the color coordinates is ± 0.01 .

CIE CHROMATICITY DIAGRAM

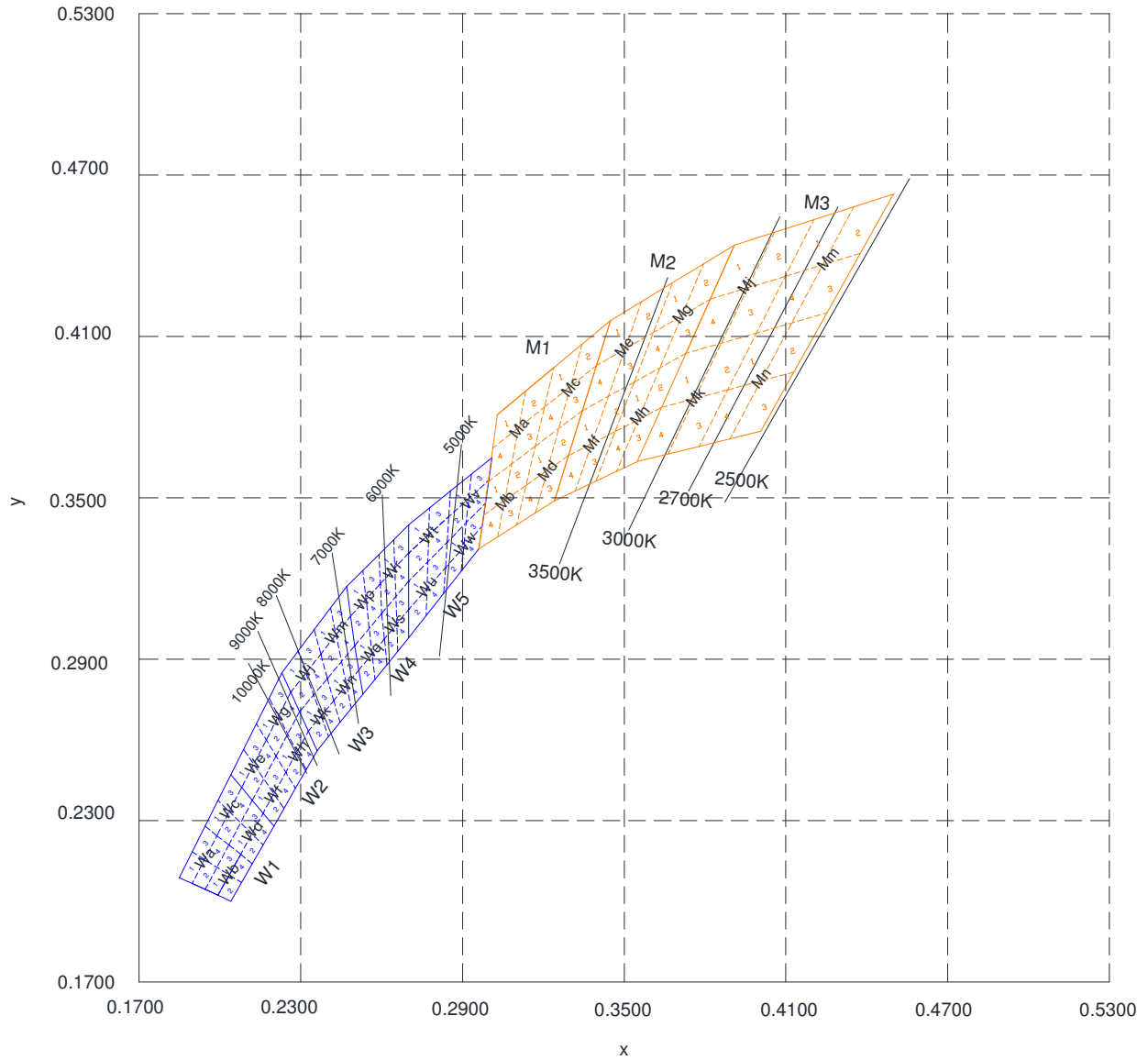

ORDER CODE TABLE*

Color	Kit Number	Luminous Intensity (mcd)		Color Bin Code
		Min.	Max.	
Cool White	CLP6B-WKW-CC0F0153	9000	22400	W1,W2,W3,W4,W5
Cool White	CLP6B-WKW-CC0E0233	9000	18000	W2,W3
Cool White	CLP6B-WKW-CC0E0453	9000	18000	W4,W5
Cool White	CLP6B-WKW-CD0E0233	11200	18000	W2,W3
Cool White	CLP6B-WKW-CD0E0453	11200	18000	W4,W5
Cool White	CLP6B-WKW-CD0F0233	11200	22400	W2,W3
Cool White	CLP6B-WKW-CD0F0453	11200	22400	W4,W5

Color	Kit Number	Luminous Intensity (mcd)		Color Bin Code
		Min.	Max.	
Warm White	CLP6B-MKW-CB0E0133	7100	18000	M1,M2,M3
Warm White	CLP6B-MKW-CB0E0233	7100	18000	M2,M3
Warm White	CLP6B-MKW-CB0E0513	7100	18000	W5,M1
Warm White	CLP6B-MKW-CC0E0233	9000	18000	M2,M3
Warm White	CLP6B-MKW-CC0E0513	9000	18000	W5,M1
Warm White	CLP6B-MKW-CC0D0233	9000	14000	M2,M3
Warm White	CLP6B-MKW-CC0D0513	9000	14000	W5,M1

Notes:

1. The above Kit numbers represent the order codes which include multiple flux-bin and color bin codes. Only one flux-bin code and one color bin code will be shipped on each reel. Single flux-bin codes and single color bin code will not be orderable.
2. Please refer to the "Cree LED Lamp Reliability Test Standards" document for reliability test conditions.
3. Please refer to the "Cree LED Lamp Soldering & Handling" document for information about how to use this LED product safely.

GRAPHS

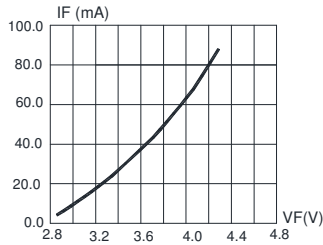

FIG.1 FORWARD CURRENT VS. FORWARD VOLTAGE.

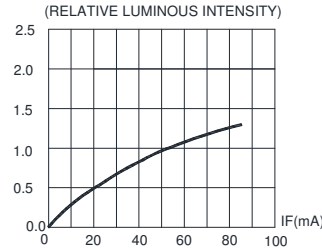

FIG.2 RELATIVE LUMINOUS INTENSITY VS. FORWARD CURRENT

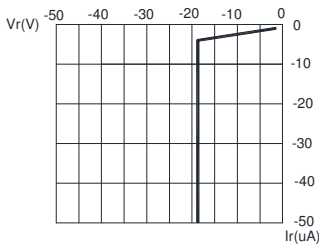

FIG.3 REVERSE CURRENT VS. REVERSE VOLTAGE.

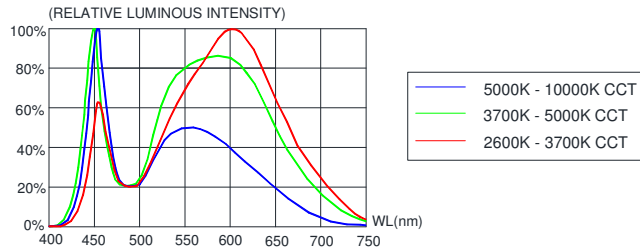

FIG.4 RELATIVE LUMINOUS INTENSITY VS. WAVELENGTH.

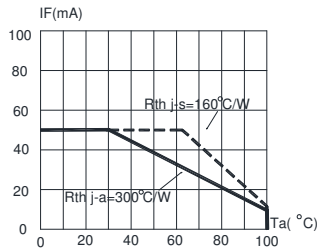

FIG.5 MAXIMUM FORWARD DC CURRENT VS AMBIENT TEMPERATURE ($T_{jmax}=110^{\circ}C$)

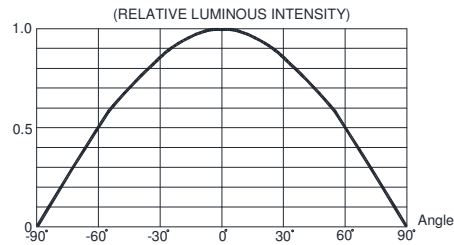
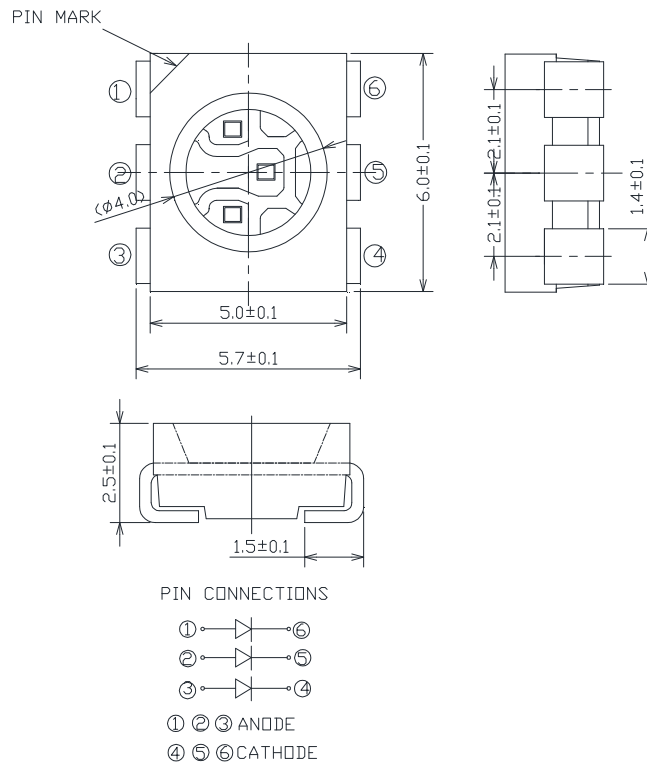

FIG.6 FAR FIELD PATTERN

The above data are collected from statistical figures that do not necessarily correspond to the actual parameters of each single LED. Hence, these data will be changed without further notice.

MECHANICAL DIMENSIONS

All dimensions are in mm.



NOTES

RoHS Compliance

The levels of environmentally sensitive, persistent biologically toxic (PBT), persistent organic pollutants (POP), or otherwise restricted materials in this product are below the maximum concentration values (also referred to as the threshold limits) permitted for such substances, or are used in an exempted application, in accordance with EU Directive 2002/95/EC on the restriction of the use of certain hazardous substances in electrical and electronic equipment (RoHS), as amended through April 21, 2006.

Vision Advisory Claim

Users should be cautioned not to stare at the light of this LED product. The bright light can damage the eye.

KIT NUMBER SYSTEM

Cree LED lamps are tested and sorted into performance bins. A bin is specified by ranges of color, forward voltage, and brightness. Sorted LEDs are packaged for shipping in various convenient options. Please refer to the "Cree LED Lamp Packaging Standard" document for more information about shipping and packaging options.

Cree LEDs are sold by order codes in combinations of bins called kits. Order codes are configured in the following manner:

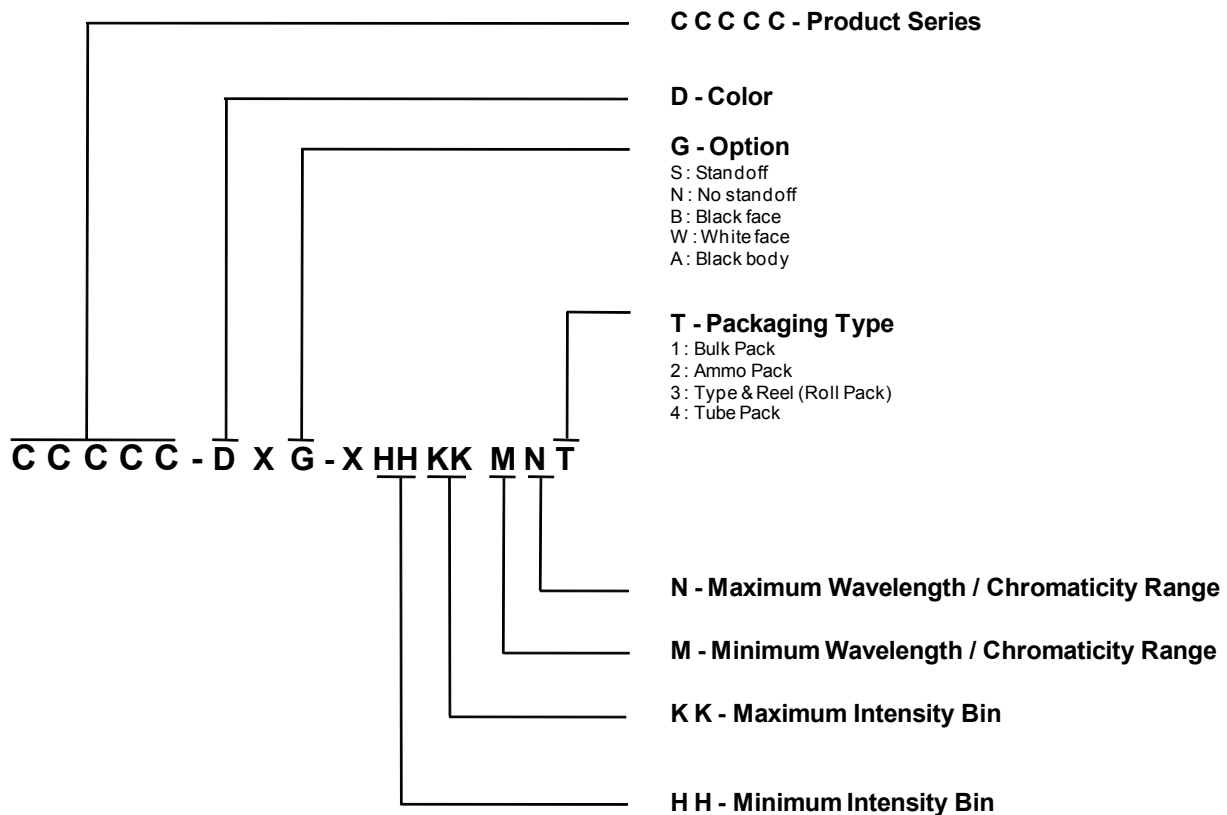

PACKAGING

- The boxes are not water-resistant, and they must be kept away from water and moisture.
- The LEDs are packed in cardboard boxes after packaging in normal or anti-electrostatic bags.
- Cardboard boxes will be used to protect the LEDs from mechanical shocks during transportation.
- The reel pack is applied in SMD LED.
- Max 900 pcs per reel.

